

# EDS-2010/2018-ML Series Quick Installation Guide

---

**Moxa EtherDevice Switch**

**Version 1.2, November 2020**

## **Technical Support Contact Information** **[www.moxa.com/support](http://www.moxa.com/support)**

### Moxa Americas:

Toll-free: 1-888-669-2872

Tel: 1-714-528-6777

Fax: 1-714-528-6778

### Moxa China (Shanghai office):

Toll-free: 800-820-5036

Tel: +86-21-5258-9955

Fax: +86-21-5258-5505

### Moxa Europe:

Tel: +49-89-3 70 03 99-0

Fax: +49-89-3 70 03 99-99

### Moxa Asia-Pacific:

Tel: +886-2-8919-1230

Fax: +886-2-8919-1231

### Moxa India:

Tel: +91-80-4172-9088

Fax: +91-80-4132-1045

# MOXA®

© 2020 Moxa Inc. All rights reserved.

**P/N: 1802020003012**



## Overview

The EDS-2010/2018-ML series of industrial Ethernet switches are equipped with 8/16-ports 10/100M copper ports and 2 10/100/1000BaseT(X) or 100/1000BaseSFP combo ports. The switches are ideal for applications that require high-bandwidth data convergence and long-distance uplinks.

The EDS-2010/2018-ML provides 12/24/48 VDC redundant power inputs, and the switches are available with a standard operating temperature range from -10 to 60°C, or with a wide operating temperature range from -40 to 75°C. The switches are rugged enough to operate reliably in harsh industrial environments.

To provide greater versatility for use with applications from different industries, the EDS-2010/2018-ML also allow users to enable or disable broadcast storm protection, Quality of Service (QoS) function, and port break alarm function with DIP switches on the outer panel.

The EDS-2010/2018-ML switches can be easily installed with DIN-Rail mounting as well as distribution boxes. The DIN-rail mounting capability and IP30 metal housing with LED indicators make the plug-and-play EDS-2010/2018-ML switches reliable and easy to use.

**NOTE** Throughout this Quick Installation Guide, we use **EDS** as an abbreviation for Moxa EtherDevice Switch:

**EDS = Moxa EtherDevice Switch**



### ATTENTION

This device complies with part 15 of FCC Rules. Operation is subject to the following two conditions: (1) This device may not cause harmful interference, and (2) this device must accept any interference received, including interference that may cause undesired operation.

## Package Checklist

Your EDS is shipped with the following items. If any of these items are missing or damaged, please contact your customer service representative for assistance.

- Moxa EtherDevice™ Switch
- Protective caps for unused ports
- Quick installation guide (printed)
- Warranty card

## Features

### **High Performance Network Switching Technology**

- 10/100/1000BaseT(X), 10/100BaseT(X) auto-negotiation speed, full/half duplex mode, auto MDI/MDI-X connection, and 100/1000Base SFP slot.
- IEEE 802.3 for 10BaseT, IEEE 802.3u for 100BaseT(X), IEEE 802.3ab for 1000BaseT, and IEEE 802.3z for 1000BaseX.
- IEEE 802.1p for Quality of Service (QoS) traffic prioritized function.
- Store-and-forward switching process type.

### **Industrial-grade Reliability**

- Power failure, port break alarm by relay output
- Redundant dual DC power inputs
- Broadcast storm protection to prevent network devices from crashing

### **Rugged Design**

- Operating temperature range from -10 to 60°C, or extended operating temperature from -40 to 75°C for “-T” models
- IP30, rugged high-strength case
- DIN-rail or panel mounting ability



### **WARNING**

The power for this product is intended to be supplied by a Listed Power Supply, with output marked LPS, and rated to deliver 12 to 48 VDC at a minimum of 0.62 A.

# Panel Layout of EDS-2010-ML-2GTXSFP /

## EDS-2018-ML-2GTXSFP

EDS-2010-ML  
Front Panel View

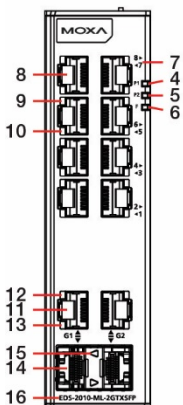

EDS-2018-ML  
Front Panel View

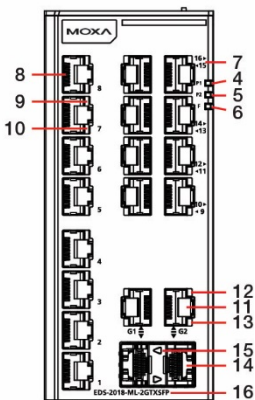

Top Panel View

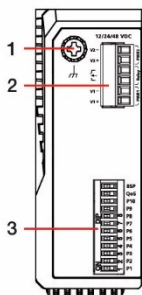

Top Panel View

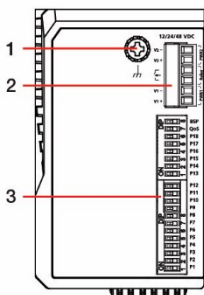

1. Grounding screw
2. Terminal block for power input (PWR1, PWR2) and relay output
3. DIP switch
4. Power input PWR1 LED
5. Power input PWR2 LED
6. Fault LED
7. Port number
8. 10/100 BaseT(X) Port
9. TP port's 100 Mbps LED
10. TP port's 10 Mbps LED
11. 10/100/1000 BaseT(X) Port
12. TP port's 1000 Mbps LED
13. TP port's 100 Mbps LED
14. 100/1000Base SFP slot
15. SFP port's 100/1000 Mbps LED
16. Model Name

# Mounting Dimensions

## EDS-2010-ML Series

Unit = mm (inch)

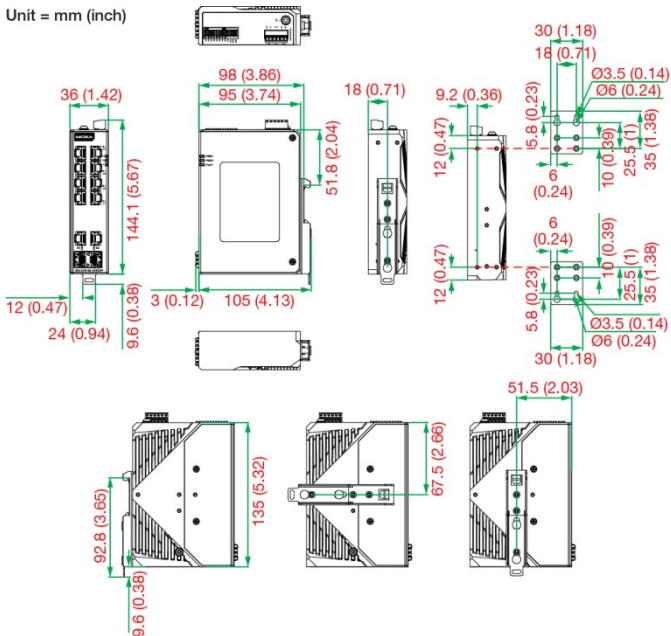

## EDS-2018-ML Series

Unit: mm (inch)

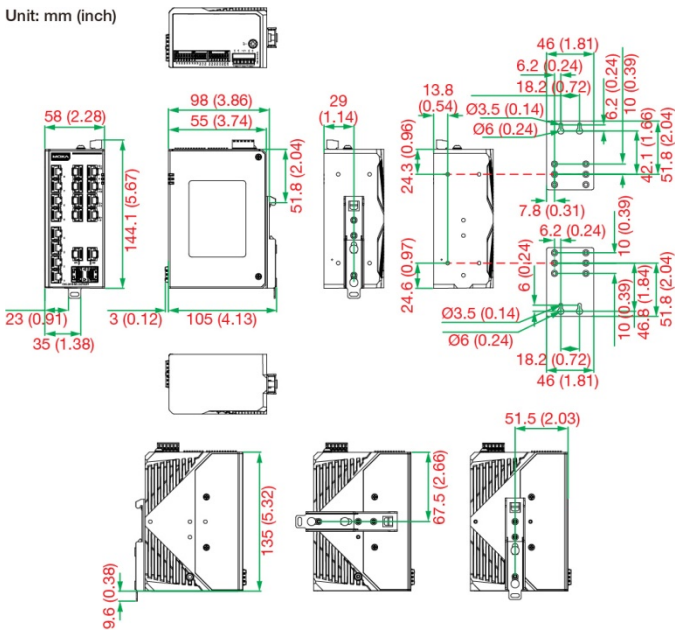

## DIN-rail Mounting

There are two options for DIN-rail mounting that can be used on an EDS. Option 1 is the default type when the product is shipped.

### Option 1 (Default):

When shipped, the metal DIN-rail mounting kit is fixed to the back panel of the EDS. Mount the EDS on the corrosion-free mounting rail that adheres to the EN 60715 standard.

#### Suggested Installation Method

##### STEP 1:

Insert the upper lip of the DIN-rail kit into the mounting rail.

##### STEP 2:

Press the device towards the mounting rail until it snaps into place.

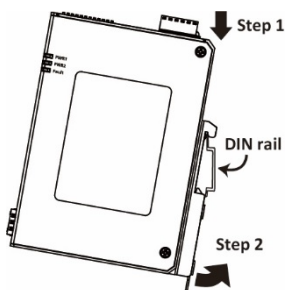

#### Suggested Removal Method

##### STEP 1:

Pull down the latch on the DIN-rail kit with a screwdriver.

##### STEP 2:

Slightly pull the device forward and lift up to remove it from the mounting rail.

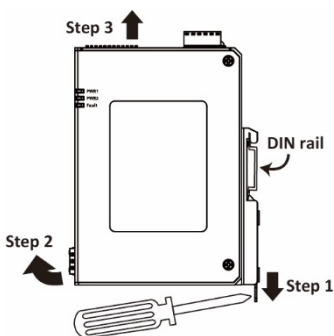

### Option 2 (when side cabling is needed):

The metal DIN-rail mounting kit can be fixed to the side panel (mold side) of the EDS (horizontal or vertical). Mount the EDS on the corrosion-free mounting rail that adheres to the EN 60715 standard.

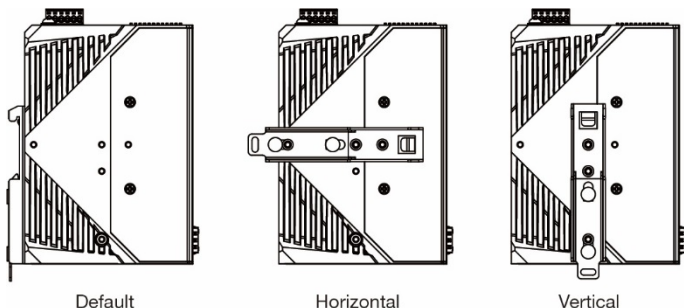

Default

Horizontal

Vertical

## **Suggested Installation Method**

### **STEP 1:**

Detach the metal DIN-rail mounting kit from the back panel and attach it to the side panel (mold side) in either the horizontal or vertical direction as indicated in the figure below.

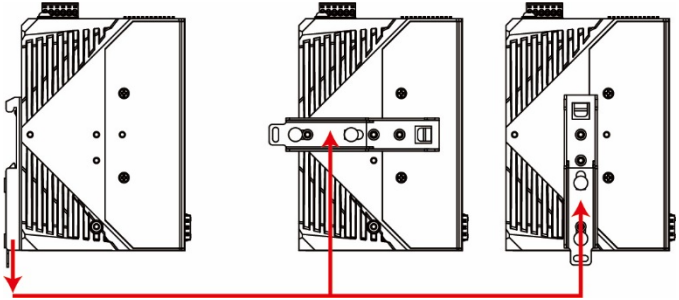

### **STEP 2:**

Insert the upper lip of the DIN-rail kit into the mounting rail.

### **STEP 3:**

Press the device towards the mounting rail until it snaps into place.

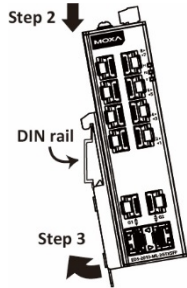

## **Suggested Removal Method**

### **STEP 1:**

Pull down the latch on the DIN-rail kit with a screwdriver.

### **STEP 2:**

Slightly pull the device forward and lift up to remove it from the mounting rail.

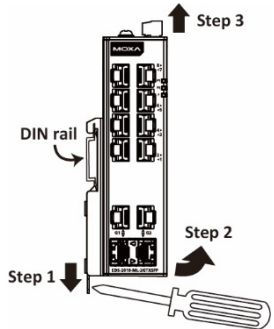

**NOTE** Screws that are used to fix the DIN-rail kit on the EDS should be securely fastened before mounting on the mounting rail. Please make sure that if you remove the DIN-rail, it must be securely fastened when it is reattached.

## Wall Mounting (optional)

For some applications, you will find it convenient to mount EDS on the wall, as illustrated below.

### STEP 1:

Remove the aluminum DIN-Rail attachment plate from EDS's rear panel, and then attach the wall mount plates, as shown in the diagram below.

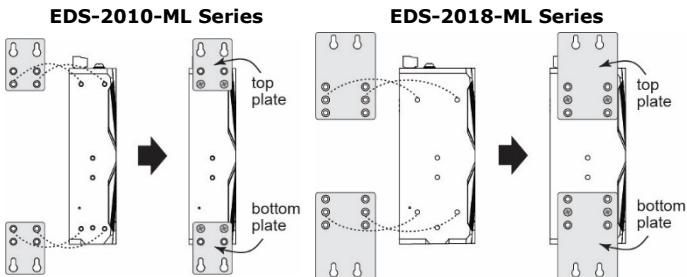

### STEP 2:

Mounting EDS on the wall requires 4 screws. Use the switch, with wall mount plates attached, as a guide to mark the correct locations of the 4 screws. The heads of the screws should be less than 6.0 mm in diameter, and the shafts should be less than 3.5 mm in diameter, as shown in the figure at the right.

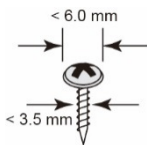

**NOTE** Before tightening screws into the wall, make sure the screw head and shank size are suitable by inserting the screw into one of the keyhole-shaped apertures of the Wall Mounting Plates.

Do not screw the screws in all the way—leave about 2 mm to allow room for sliding the wall mount panel between the wall and the screws.

### STEP 3:

Once the screws are fixed in the wall, insert the four screw heads through the large parts of the keyhole-shaped apertures, and then slide EDS downwards, as indicated. Tighten the four screws for added stability.

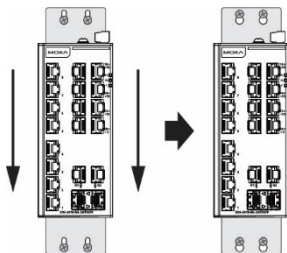

## WARNING

1. External metal parts are hot. Take necessary precautions if it is necessary to touch.



## Wiring Requirements



### WARNING

Do not disconnect modules or wires unless the power supply has been switched off or the area is known to be non-hazardous. The devices may only be connected to the supply voltage shown on the type plate.

The devices are designed for operation with a Safety Extra-Low Voltage. Thus, they may only be connected to the supply voltage connections and to the signal contact with the Safety Extra-Low Voltages (SELV) in compliance with IEC950/ EN60950/ VDE0805.



### WARNING

#### **Safety First!**

Be sure to disconnect the power cord before installing and/or wiring your Moxa EtherDevice Switch.

Calculate the maximum possible current in each power wire and common wire. Observe all electrical codes dictating the maximum current allowable for each wire size.

If the current goes above the maximum ratings, the wiring could overheat, causing serious damage to your equipment.

You should also pay attention to the following items:

- Use separate paths to route wiring for power and devices. If power wiring and device wiring paths must cross, make sure the wires are perpendicular at the intersection point.  
**NOTE:** Do not run signal or communications wiring and power wiring in the same wire conduit. To avoid interference, wires with different signal characteristics should be routed separately.
- You can use the type of signal transmitted through a wire to determine which wires should be kept separate. The rule of thumb is that wiring that shares similar electrical characteristics can be bundled together.
- Keep input wiring and output wiring separated.
- It is strongly advised that you label wiring to all devices in the system when necessary.

## Grounding Moxa EtherDevice Switch

Grounding and wire routing help limit the effects of noise due to electromagnetic interference (EMI). Run the ground connection from the ground screw to the grounding surface prior to connecting devices.

A 4 mm<sup>2</sup> conductor must be used when a connection to the external grounding screw is utilized.



### ATTENTION

This product is intended to be mounted to a well-grounded mounting surface, such as a metal panel.

## Wiring the Alarm Contact

The Alarm Contact consists of the two middle contacts of the terminal block on EDS's top panel. You may refer to the next section for detailed instructions on how to connect the wires to the terminal block connector, and how to attach the terminal block connector to the terminal block receptor. In this section, we explain the meaning of the two contacts used to connect the Alarm Contact.

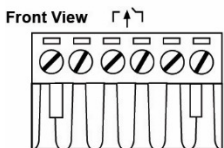
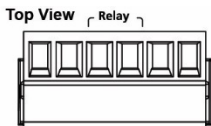

**FAULT:** The two middle contacts of the 6-contact terminal block connector are used to detect both power faults and port faults. The two wires attached to the Fault contacts form an open circuit when:

1. The EDS has lost power from one of the DC power inputs.
- OR
2. One of the ports for which the corresponding PORT ALARM DIP Switch is set to ON is not properly connected.

If neither of these two conditions is satisfied, the Fault circuit will be closed.

## Wiring the Redundant Power Inputs

The top two contacts and the bottom two contacts of the 6-contact terminal block connector on the EDS's top panel are used for the EDS's two DC inputs. Top and front views of one of the terminal block connectors are shown here.

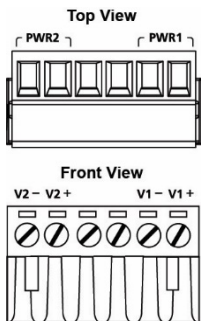

### STEP 1:

Insert the negative/positive DC wires into the V-/V+ terminals.

### STEP 2:

To keep the DC wires from pulling loose, use a small flat-blade screwdriver to tighten the wire-clamp screws on the front of the terminal block connector.

### STEP 3:

Insert the plastic terminal block connector prongs into the terminal block receptor, which is located on the EDS's top panel.



### ATTENTION

Before connecting the EDS to the DC power inputs, make sure the DC power source voltage is stable.



### ATTENTION

One individual conductor in a clamping point with 28-14 AWG wire size, and a torque value of 1.7 lb-in should be used.

## Communication Connections

The EDS-2010/2018-ML models have 10/100BaseT(X) Ethernet ports, 10/100/1000BaseT(X) Ethernet ports, and 100/1000BaseSFP.

### 10/100BaseT(X) Ethernet Port Connection

The 10/100BaseT(X) ports located on the EDS's front panel are used to connect to Ethernet-enabled devices.

Below we show pinouts for both MDI (NIC-type) ports and MDI-X (HUB/Switch-type) ports, and also show cable wiring diagrams for straight-through and cross-over Ethernet cables.

## 10/100Base T(x) RJ45 Pinouts

**MDI Port Pinouts**

Pin	Signal
1	Tx+
2	Tx-
3	Rx+
6	Rx-

**MDI-X Port Pinouts**

Pin	Signal
1	Rx+
2	Rx-
3	Tx+
6	Tx-

**8-pin RJ45**

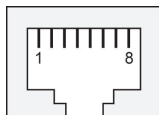

## RJ45 (8-pin) to RJ45 (8-pin) Straight-through Cable Wiring

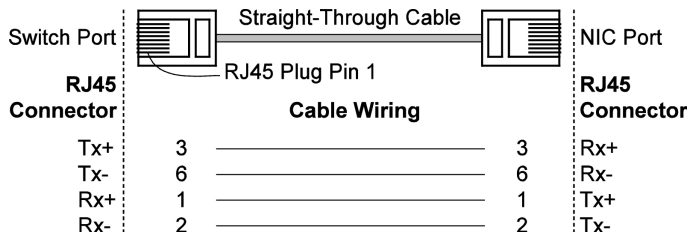

## RJ45 (8-pin) to RJ45 (8-pin) Cross-over Cable Wiring

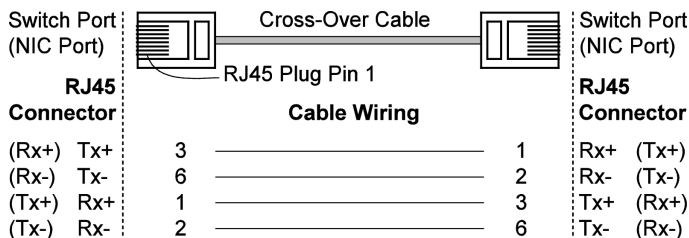

## 10/100/1000BaseT(X) Ethernet Port Connection

The 10/100/1000BaseT(X) ports located on Moxa EtherDevice Switch's front panel are used to connect to Ethernet-enabled devices. Most users will choose to configure these ports for Auto MDI/MDI-X mode, in which case the port's pinouts are adjusted automatically depending on the type of Ethernet cable used (straight-through or cross-over), and the type of device (NIC-type or HUB/Switch-type) connected to the port.

In the following section, we give pinouts for both MDI (NIC-type) ports and MDI-X (HUB/Switch-type) ports. We also give cable wiring diagrams for straight-through and cross-over Ethernet cables.

## 10/100Base T(x) RJ45 Pinouts

**MDI Port Pinouts**

Pin	Signal
1	Tx+
2	Tx-
3	Rx+
6	Rx-

**MDI-X Port Pinouts**

Pin	Signal
1	Rx+
2	Rx-
3	Tx+
6	Tx-

**8-pin RJ45**

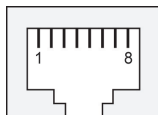

## 1000BaseT RJ45 Pinouts

Pin	MDI	MDI-X
1	BI_DA+	BI_DB+
2	BI_DA-	BI_DB-
3	BI_DB+	BI_DA+
4	BI_DC+	BI_DD+
5	BI_DC-	BI_DD-
6	BI_DB-	BI_DA-
7	BI_DD+	BI_DC+
8	BI_DD-	BI_DC-

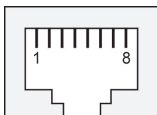

## RJ45 (8-pin) to RJ45 (8-pin) Straight-through Cable Wiring

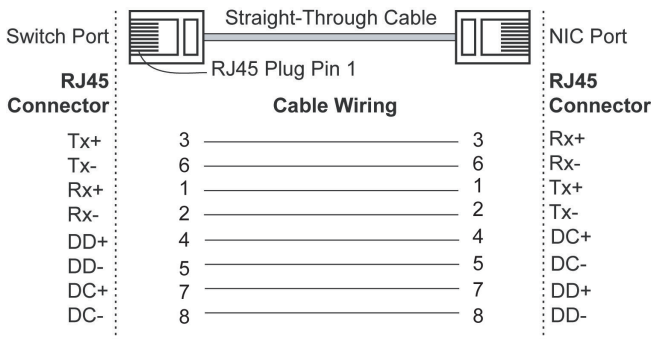

## RJ45 (8-pin) to RJ45 (8-pin) Cross-over Cable Wiring

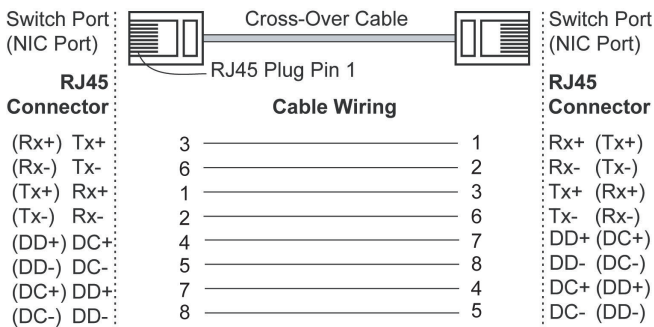

## 100/1000Base-X Fiber Port

The Fiber ports on the EDS-2010/2018-ML Series are SFP type slots, which support both 100Base-FX and 1000Base-X speeds. Moxa provides complete transceiver models for various distance requirements.

The concept behind the LC port and cable is quite straightforward. Suppose you are connecting devices I and II. Unlike electrical signals, optical signals do not require a circuit in order to transmit data. Consequently, one of the optical lines is used to transmit data from device I to device II, and the other optical line is used to transmit data from device II to device I, for full-duplex transmission.

Remember to connect the Tx (transmit) port of device I to the Rx (receive) port of device II, and the Rx (receive) port of device I to the Tx (transmit) port of device II. If you make your own cable, we suggest labeling the two sides of the same line with the same letter (A-to-A and B-to-B, as shown below, or A1-to-A2 and B1-to-B2).

### LC-port Pinouts

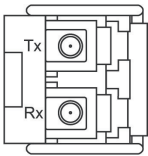

### LC-port to LC-port Cable Wiring

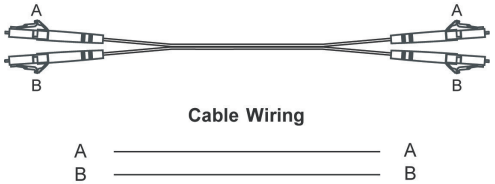

### ATTENTION

This is a Class 1 Laser/LED product. To avoid causing serious damage to your eyes, do not stare directly into the Laser Beam.

## Redundant Power Inputs

Both power inputs can be connected simultaneously to live DC power sources. If one power source fails, the other live source acts as a backup, and automatically supplies all of EDS's power needs.

## Alarm Contact

The Moxa EtherDevice Switch has one Alarm Contact located on the top panel. For detailed instructions on how to connect the Alarm Contact power wires to the two middle contacts of the 6-contact terminal block connector, see the Wiring the Alarm Contact section on page 10. A typical scenario would be to connect the Fault circuit to a warning light located in the control room. The light can be set up to switch on when a fault is detected.

The Alarm Contact has two terminals that form a Fault circuit for connecting to an alarm system. The two wires attached to the Fault contacts form an open circuit when (1) EDS has lost power from one of the DC power inputs, or (2) one of the ports for which the corresponding PORT ALARM DIP Switch is set to ON is not properly connected. If neither of these two conditions occurs, the Fault circuit will be closed.

**NOTE** The DIP settings will be activated when the device is powered on the next time.

## DIP Switch Settings

### EDS-2010-ML Series DIP Switches

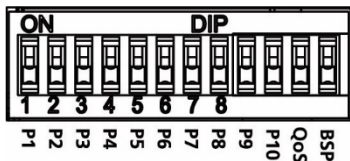

DIP Switch	Setting	Description															
Port Alarm Function P1 to P8 P9 is G1 P10 is G2	ON	Enables the corresponding PORT Alarm. If the port's link fails, the relay will form an open circuit and the fault LED will light up.															
	OFF	Disables the corresponding PORT Alarm. The relay will form a closed circuit and the Fault LED will never light up.															
Quality of Service (QoS)	ON	Enable the Quality of Service to handle packet priorities in four WRR queues. <i>QoS priority mapping matrix in each queue</i> <table border="1" data-bbox="393 971 979 1124"> <thead> <tr> <th>QoS 3bit priority</th> <th>7, 6</th> <th>5, 4</th> <th>3, 2</th> <th>1, 0</th> </tr> </thead> <tbody> <tr> <th>Queues</th> <td>3</td> <td>2</td> <td>1</td> <td>0</td> </tr> <tr> <th>WRR</th> <td>8</td> <td>4</td> <td>2</td> <td>1</td> </tr> </tbody> </table>	QoS 3bit priority	7, 6	5, 4	3, 2	1, 0	Queues	3	2	1	0	WRR	8	4	2	1
	QoS 3bit priority	7, 6	5, 4	3, 2	1, 0												
Queues	3	2	1	0													
WRR	8	4	2	1													
OFF	Disable the Quality of Service.																
Broadcast Storm Protection (BSP)	ON	Enables broadcast storm protection (at a maximum of 2000 broadcast packets per second) in the EDS switch for all ports.															
	OFF	Disables the broadcast storm protection.															

## EDS-2018-ML Series DIP Switches

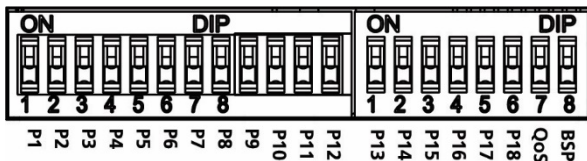

DIP Switch	Setting	Description															
Port Alarm Function P1 to P16 P17 is G1 P18 is G2	ON	Enables the corresponding PORT Alarm. If the port's link fails, the relay will form an open circuit and the fault LED will light up.															
	OFF	Disables the corresponding PORT Alarm. The relay will form a closed circuit and the Fault LED will never light up.															
Quality of Service (QoS)	ON	Enable the Quality of Service to handle packet priorities in four WRR queues. <i>QoS priority mapping matrix in each queue</i>															
		<table border="1"> <thead> <tr> <th>QoS 3bit priority</th> <th>7, 6</th> <th>5, 4</th> <th>3, 2</th> <th>1, 0</th> </tr> </thead> <tbody> <tr> <th>Queues</th> <td>3</td> <td>2</td> <td>1</td> <td>0</td> </tr> <tr> <th>WRR</th> <td>8</td> <td>4</td> <td>2</td> <td>1</td> </tr> </tbody> </table>	QoS 3bit priority	7, 6	5, 4	3, 2	1, 0	Queues	3	2	1	0	WRR	8	4	2	1
	QoS 3bit priority	7, 6	5, 4	3, 2	1, 0												
Queues	3	2	1	0													
WRR	8	4	2	1													
OFF	Disable the Quality of Service.																
Broadcast Storm Protection (BSP)	ON	Enables broadcast storm protection (at a maximum of 2000 broadcast packets per second) in the EDS switch for all ports.															
	OFF	Disables broadcast storm protection.															

## LED Indicators

The front panel of the Moxa EtherDevice Switch contains several LED indicators. The function of each LED is described in the table below.

LED	Color	State	Description
<b>PWR1</b>	AMBER	On	Power is being supplied to power input PWR1.
		Off	Power is not being supplied to power input PWR1.
<b>PWR2</b>	AMBER	On	Power is being supplied to power input PWR2.
		Off	Power is not being supplied to power input PWR2.
<b>FAULT</b>	Red	On	When the corresponding PORT alarm is enabled, and the port's link is inactive.
		Off	When the corresponding PORT alarm is enabled and the port's link is active, or when the corresponding PORT alarm is disabled.
<b>10M/100M/1000M Copper Top LED</b>	Green	On	TP port's 1000Mbps link is active.
		Blinking	Data is being transmitted at 1000Mbps.
		Off	TP port's 1000Mbps link is inactive.



LED	Color	State	Description
<b>10M/100M/1000M Copper Bottom LED</b>	Green	On	TP port's 10/100Mbps link is active.
		Blinking	Data is being transmitted at 10/100Mbps.
		Off	TP port's 10/100Mbps link is inactive.
<b>10M/100M Copper Top LED</b>	Green	On	TP port's 100Mbps link is active.
		Blinking	Data is being transmitted at 100Mbps.
		Off	TP port's 100Mbps link is inactive.
<b>10M/100M Copper Bottom LED</b>	Green	On	TP port's 10Mbps link is active.
		Blinking	Data is being transmitted at 10Mbps.
		Off	TP port's 10Mbps link is inactive.
<b>100M/1000M (SFP port)</b>	Green	On	When the port is active and links on 1000Mbps.
		Blinking	When the port's data is being transmitted at 1000Mbps.
		Off	When the port is inactive or link down.
	Amber	On	When the port is active and links on 100Mbps.
		Blinking	When the port's data is being transmitted at 100Mbps.
		Off	When the port is inactive or link down.

## Auto MDI/MDI-X Connection

The Auto MDI/MDI-X function allows users to connect the EDS's 10/100/1000BaseT(X) ports to any kind of Ethernet device, without paying attention to the type of Ethernet cable being used for the connection. This means that you can use either a straight-through cable or cross-over cable to connect the EDS to Ethernet devices.

## Triple Speed Functionality and Switching

The EDS's 10/100/1000 Mbps RJ45 switched port auto negotiates with the connected device for the fastest data transmission rate supported by both devices. The EDS is a plug-and-play device, so software configuration is not required at installation or during maintenance.

The half/full duplex mode for the RJ45 switched ports is user dependent and changes (by auto-negotiation) to full or half duplex, depending on which transmission speed is supported by the attached device.

## **Switching, Filtering, and Forwarding**

Each time a packet arrives at one of the switched ports, a decision is made to either filter or forward the packet. Packets with source and destination addresses belonging to the same port segment will be filtered, constraining those packets to one port, and relieving the rest of the network from the need to process them. A packet with destination address on another port segment will be forwarded to the appropriate port, and will not be sent to the other ports where it is not needed. Packets that are used in maintaining the operation of the network (such as the occasional multi-cast packet) are forwarded to all ports. EDS operates in the store-and-forward switching mode, which eliminates bad packets and enables peak performance to be achieved when there is heavy traffic on the network.

## **Switching and Address Learning**

Moxa EDS has an address table that can hold up to 8K node addresses, which makes it suitable for use with large networks. The address tables are self-learning, so that as nodes are added or removed, or moved from one segment to another, EDS automatically keeps up with new node locations. An address-aging algorithm causes the least-used addresses to be deleted in favor of newer, more frequently used addresses. To reset the address buffer, power down the unit and then power it back up.

## **Auto-Negotiation and Speed Sensing**

The EDS's RJ45 Ethernet ports independently support auto-negotiation for transmission speeds of 10 Mbps, 100 Mbps, and 1000 Mbps, with operation according to the IEEE802.3 standard. This means that some nodes could be operating at 10 Mbps, while at the same time, other nodes are operating at 100 Mbps or 1000 Mbps.

Auto-negotiation takes place when an RJ45 cable connection is made, and then each time a LINK is enabled. The EDS advertises its capability for using 10 Mbps, 100 Mbps, or 1000 Mbps transmission speeds, with the device at the other end of the cable expected to advertise similarly.

Depending on what type of device is connected, this will result in agreement to operate at a speed of 10 Mbps, 100 Mbps, or 1000 Mbps. If an EDS's RJ45 Ethernet port is connected to a non-negotiating device, it will default to 10 Mbps speed and half-duplex mode, as required by the IEEE802.3 standard.

## Specifications

<b>Technology</b>	
Standards	IEEE 802.3 for 10BaseT, IEEE 802.3u for 100BaseT(X) and 100Base FX, IEEE 802.3ab for 1000BaseT, IEEE 802.3z for 1000BaseSX/LX/LHX/ZX IEEE 802.1p for Class of Service
Flow Control	IEEE 802.3x flow control, back pressure flow control
<b>Interface</b>	
RJ45 Ports	10/100BaseT(X) and 10/100/1000BaseT(X) auto negotiation speed
Fiber Ports	100/1000Base-X SFP slot
LED Indicators	PWR1, PWR2, Fault, 10/100M, 10/100M/1000M, 100M, 1000M
DIP Switch	Port break alarm, QoS, BSP
Alarm Contact	One relay output with current carrying capacity of 1A @ 24 VDC
<b>Switch Properties</b>	
MAC Table Size	8 K
Packet Buffer Size	4 Mbits
Processing Type	Store and Forward
<b>Power</b>	
Input Voltage	12/24/48 VDC redundant dual inputs
Input Current	EDS-2010-ML: 0.606 A (max.) EDS-2018-ML: 0.617 A (max.) Relay output: 24 VDC, 1 A, Resistance
Connection	Removable 6-contact terminal block 28-14 AWG, 1.71 in-lbs All wires must be able to withstand at least 90°C
Overload Current Protection	Present
Reverse Polarity Protection	Present
<b>Mechanical</b>	
Casing	IP30 protection, metal case
Dimensions (W x H x D)	EDS-2010-ML: 36 x 135 x 95 mm (1.41 x 5.31 x 3.74 in) EDS-2018-ML: 58 x 135 x 95 mm (2.28 x 5.31 x 3.74 in)
Weight	EDS-2010-ML: 498 g (1.10 lb) EDS-2018-ML: 683 g (1.51 lb)
Installation	DIN-rail, Wall Mounting (optional kit)
<b>Environmental Limits</b>	
Note: Only for indoor use.	
Operating Temperature	-10 to 60°C (32 to 140°F) -40 to 75°C (-40 to 167°F) for -T models
Storage Temperature	-40 to 85°C (-40 to 185°F)
Ambient Relative Humidity	5 to 95% (non-condensing)

<b>Regulatory Approvals</b>	
Safety	UL 61010-2-201, EN 62368-1(LVD)
EMI	FCC Part 15, CISPR (EN55032) class A
EMS	EN61000-4-2 (ESD), Level 3 EN61000-4-3 (RS), Level 3 EN61000-4-4 (EFT), Level 3 EN61000-4-5 (Surge), Level 3 EN61000-4-6 (CS), Level 3 EN61000-4-8
Hazardous Location*	UL/cUL Class I, Division 2, Groups A, B, C, and D; ATEX Zone 2, IECEx, Ex nA nC IIC T4 Gc
Maritime*	DNV GL, ABS, LR, NK
Rail Traffic*	EN 50121-4
Traffic Control	NEMA TS2
Shock	IEC60068-2-27
Free Fall	IEC60068-2-32
Vibration	IEC60068-2-6
<b>Note: Please check Moxa's website for the latest certification status.</b>	
<b>MTBF (mean time between failures)</b>	
Time	EDS-2010-ML Series: 2,174,016 hours EDS-2018-ML Series: 1,776,132 hours
Standard	Telcordia (Bellcore), GB
<b>WARRANTY</b>	5 years

## General Safety Before Use

Read the information about installation, configuration and operation of this equipment before you install, configure, operate, or maintain this product. Users are required to familiarize themselves with installation and wiring instructions in addition to requirements of all applicable codes, laws, and standards.

Activities including installation, adjustments, putting into service, use, assembly, disassembly, and maintenance are required to be carried out by suitably trained personnel in accordance with applicable code of practice.

If the equipment is used in a manner not specified by the manufacturer, the protection provided by the equipment may be impaired. The manufacturer is not responsible for any accident caused by the scenario mentioned above.

This equipment is intended for use in a Pollution Degree 2 industrial environment, in overvoltage Category II applications (as defined in IEC 60664-1), at altitudes up to 2000 m (6562 ft) without derating.

This equipment is supplied as open-type equipment for indoor use.

## Hazardous Location Information



1. Certificate number: ATEX: UL 20 ATEX 2401X  
IECEX: IECEX UL 20.0081X
2. Ambient range:  
-40°C ≤ Tamb ≤ 75°C for model with suffix -T only  
-10°C ≤ Tamb ≤ 60°C for model without suffix -T only
3. Certification string:  
ATEX:  
EDS-2010/2018-ML Series: Ex nA nC IIC T4 Gc  
IECEX:  
EDS-2010/2018-ML Series: Ex nA nC IIC T4 Gc
4. Standards covered:  
EN 60079-0:2012+A11:2013/IEC 60079-0 Ed.6  
EN 60079-15:2010/IEC 60079-15 Ed.4
5. The conditions of safe usage:
  - These devices are open-type devices that are to be installed in an enclosure only accessible with the use of a tool and suitable for the environment.
  - These devices shall be mounted in a suitable tool-accessible ATEX/IECEX Certified enclosure rated to at least IP54 as defined in EN/IEC 60529 and IEC 60079-0 and Pollution Degree 2 as defined in EN/IEC 60664-1, and used within their rated electrical and environmental ratings.
  - Conductors suitable for Rated Cable Temperature ≥ 90°C
  - WARNING—EXPLOSION HAZARD – Do not disconnect equipment unless power has been removed or the area is known to be non-hazardous.
  - WARNING—EXPLOSION HAZARD – Substitution of any components may impair suitability for Class I, Division 2.
  - This equipment is suitable for use in Class I, Division 2, Groups A, B, C, and D or non-hazardous locations only.

Address of manufacturer: FI.4, No.135, Lane 235, Baoqiao Rd. Xindian Dist., New Taipei City, Taiwan