

EXPC-F2000W Panel Computer Hardware User Manual

Version 1.0, January 2024

www.moxa.com/products



© 2024 Moxa Inc. All rights reserved.

EXPC-F2000W Panel Computer Hardware User Manual

The software described in this manual is furnished under a license agreement and may be used only in accordance with the terms of that agreement.

Copyright Notice

© 2024 Moxa Inc. All rights reserved.

Trademarks

The MOXA logo is a registered trademark of Moxa Inc.
All other trademarks or registered marks in this manual belong to their respective manufacturers.

Disclaimer

- Information in this document is subject to change without notice and does not represent a commitment on the part of Moxa.
- Moxa provides this document as is, without warranty of any kind, either expressed or implied, including, but not limited to, its particular purpose. Moxa reserves the right to make improvements and/or changes to this manual, or to the products and/or the programs described in this manual, at any time.
- Information provided in this manual is intended to be accurate and reliable. However, Moxa assumes no responsibility for its use, or for any infringements on the rights of third parties that may result from its use.
- This product might include unintentional technical or typographical errors. Changes are periodically made to the information herein to correct such errors, and these changes are incorporated into new editions of the publication.

Technical Support Contact Information

www.moxa.com/support

Table of Contents

1. Introduction	5
Overview	5
Package Checklist	5
Features and Benefits	5
Hardware Specifications	6
Hardware Block Diagram	6
2. Hardware Introduction	7
Appearance	7
Front View	7
Bottom View	8
Dimensions	9
Touch Panel Buttons and LEDs	10
3. Hardware Connection Description	12
Installing the EXPC-F2000W Panel Computers	12
Notes on Installing and Mounting	12
Panel Mounting	13
VESA Mounting (optional)	15
Wiring Requirements	15
Grounding	16
Temperature Requirements	16
Powering On/Off the EXPC-F2000W	17
Touch Panel Buttons and LEDs	18
Extending the Displays	19
Connecting Data Transmission Cables	20
Connecting to a Network	20
Connecting to a Serial Device	21
Connecting to a Speaker or a Headphone	21
Connecting to USB Devices	22
Installing Additional Storage: SSD	23
Installing a CFexpress Card	25
Real-time Clock	26
4. BIOS Setup	27
Entering the BIOS Setup Utility	27
Main Page	29
Advanced Settings	29
Boot Configuration	30
SATA Configuration	30
CPU Configuration	31
Video Configuration	32
Chipset Configuration	33
Console Redirection	36
SIO ITE8786E	37
Security Settings	38
Current TPM Device	38
TPM State	38
Clear TPM	38
Set Supervisor Password	39
Power Settings	40
Wake on LAN	41
Auto Wake on S5	41
M.2 B Key Power	41
M.2 E Key Power	41
Boot Settings	42
Network Stack	42
PXE Boot capability	42
USB Boot	42
Timeout	43
EFI	43

Exit Settings	44
Exit Saving Changes	44
Save Change Without Exit	44
Exit Discarding Changes	44
Load Optimal Defaults	44
Load Custom Defaults	44
Save Custom Defaults	45
Discard Changes	45
AMT	45
Enabling AMT	45
Using AMT	49
Administering Secure Boot	50
Enabling UEFI Secure Boot	51
Enroll EFI Image	51
Enroll Customer Key	52
Upgrading the BIOS	54
Step 1: Create a Bootable USB Disk	54
Step 2: Prepare the Upgrade File	55
Step 3: Run the Upgrade Program on Your Computer	56
5. Configuring the Serial Interface	58
Overview	58
Installing the SerialInterface Utility	58
Configuring the Serial Interface Mode	60
A. Regulatory Approval Statement	62

1. Introduction

In this chapter, we give a general introduction to the features and specifications of EXPC-F2000W panel computers.

Overview

The EXPC-F2000W family consists of 12.1-inch and 15.6-inch panel computers with 11th Gen Intel Core™ i processor to deliver a reliable, durable, and versatile platform for use in industrial, non-hazardous, and mission-critical environments. The EXPC-F2000W panel computers come with a rich set of IO interfaces to satisfy most industrial application scenarios. They are also provided with a DisplayPort and VGA video outputs, enabling the extension of the display.

The EXPC-F2000W panel computers come in a fanless design for operations in the -40 to 70°C temperature range and a streamlined enclosure for efficient heat dissipation, making them the most reliable industrial platforms available for harsh, hot, outdoor environments such as oil and gas fields, drilling platforms, and power stations, as well as smart heater solutions. The panel computers are also designed with sunlight-readable features such as a 1200-nit LCD panel, projected-capacitive, glove-friendly, multi-touch, anti-glare screen, and optical bonding, to provide an excellent user experience for outdoor applications.

Package Checklist

The EXPC-F2000W panel computer is shipped with the following items:

- 1 EXPC-F2150W or 1 EXPC-F2120W panel computer
- 1 2-pin terminal block for remote power switch
- 1 2-pin terminal block for DC power connector (DC models)
- 1 C14-male-to-C15-female AC short power cord adapter
- Panel mounting kit (EXPC-F2120W: 10 pieces, EXPC-F2150W: 13 pieces)
- Quick installation guide (printed)
- Warranty card



NOTE

Notify your sales representative if any of the above items are missing or damaged.

Features and Benefits

- 15.6 inch 16:9 or 12.1 inch 16:10 display
- High-performance Tiger Lake Intel® Celeron®/Core™ i3/i7 processor
- Built-in light sensor for auto brightness control
- 1200-nit sunlight-readable anti-glare display
- Optical bonding for display for deploying in harsh environments
- Front IP66 and rear IP42 compliant
- -40 to 70°C operating temperature range
- Fanless thermal design for efficient heat dissipation in high temperature environments
- UL C1D2/C2D2, ATEX, and IECEx ZONE 2/Zone 22 compliant
- Options for 5G and Wi-Fi 6 connections
- Designed for deploying in hazardous locations and for mission-critical applications

Hardware Specifications



NOTE

The latest specifications for Moxa's products can be found at <https://moxa.com>.

Hardware Block Diagram

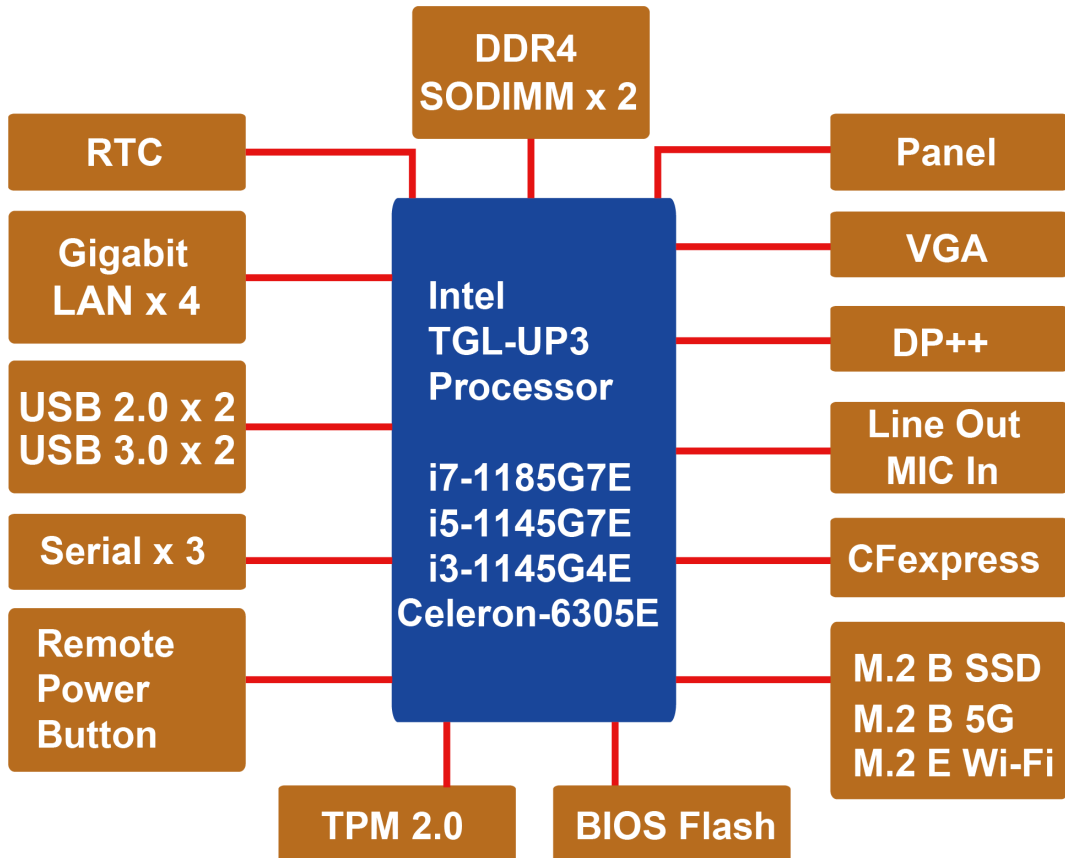

2. Hardware Introduction

The EXPC-F2000W computer is compact, well-designed, and ruggedized for industrial applications. The intelligent OSD display control buttons allow you to indicate control buttons easily in low light environment and identify system hardware failure easily. Multiple serial ports allow you to connect different devices for data operation, and the reliable and stable hardware platform lets you devote your attention to developing your applications.

Appearance

Front View

EXPC-F2120W Series

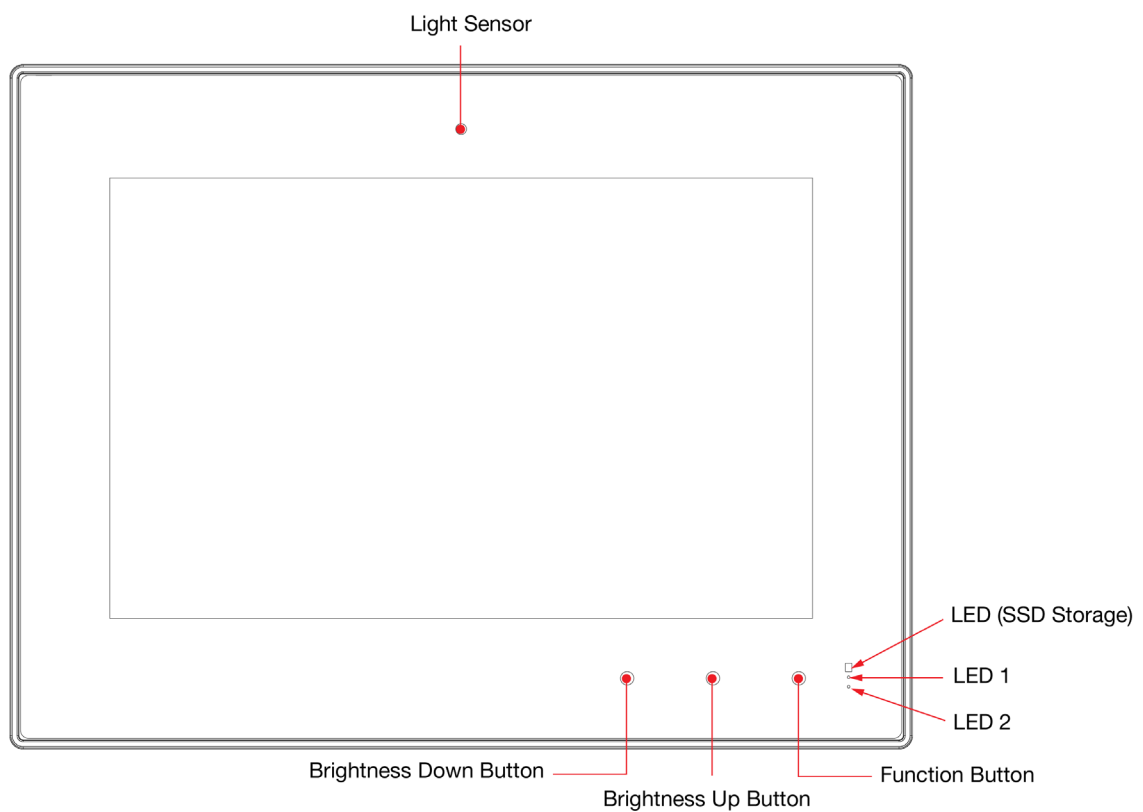

EXPC-F2150W Series

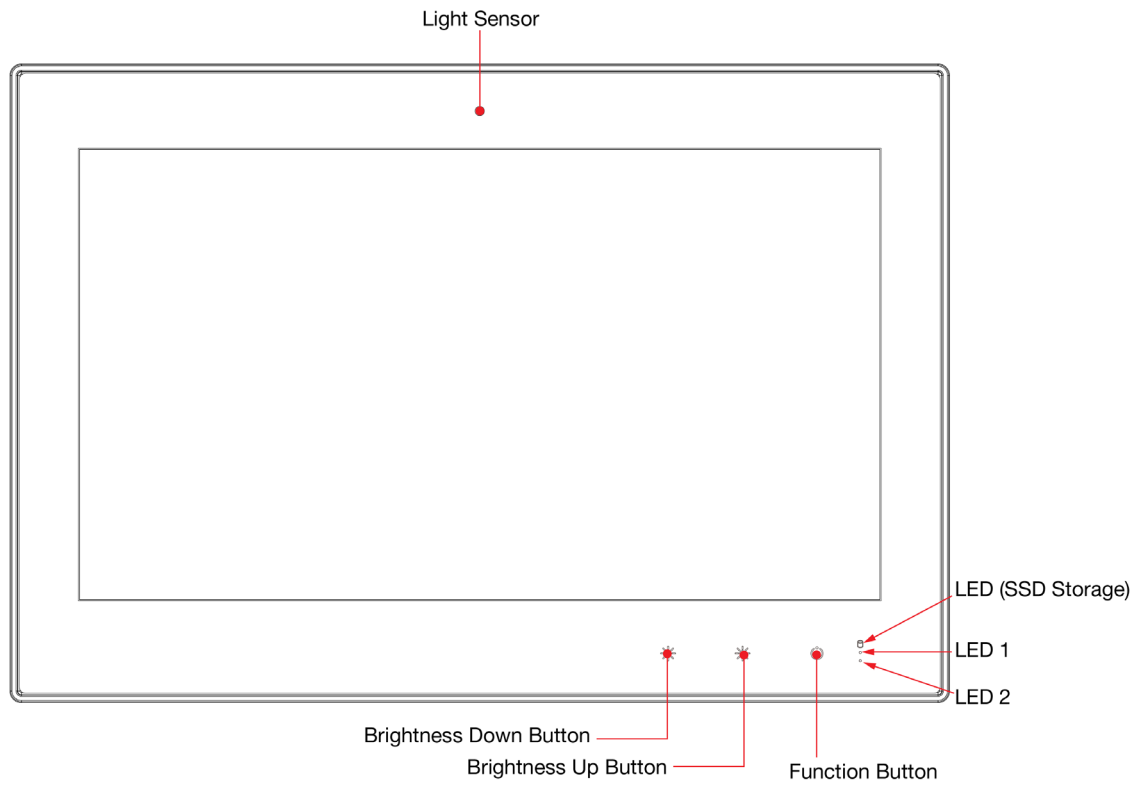

Bottom View

AC Models

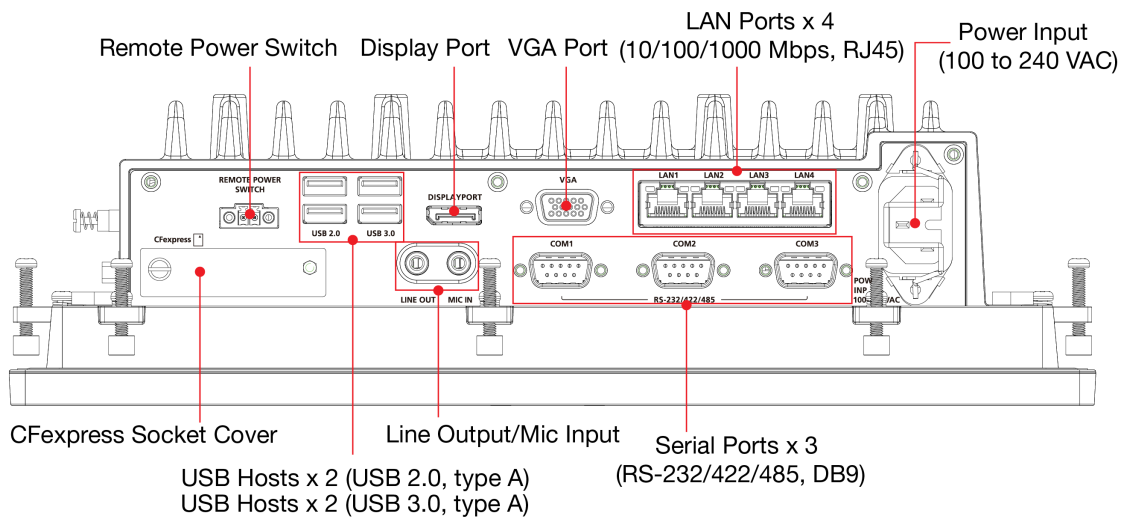

DC Models

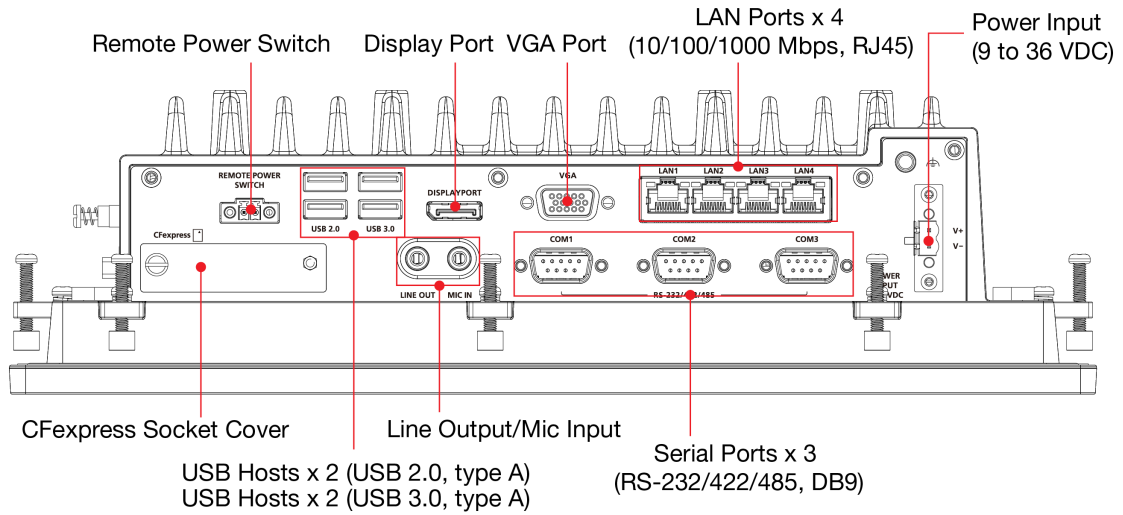

Dimensions

EXPC-F2120W Series

Unit: mm (inch)

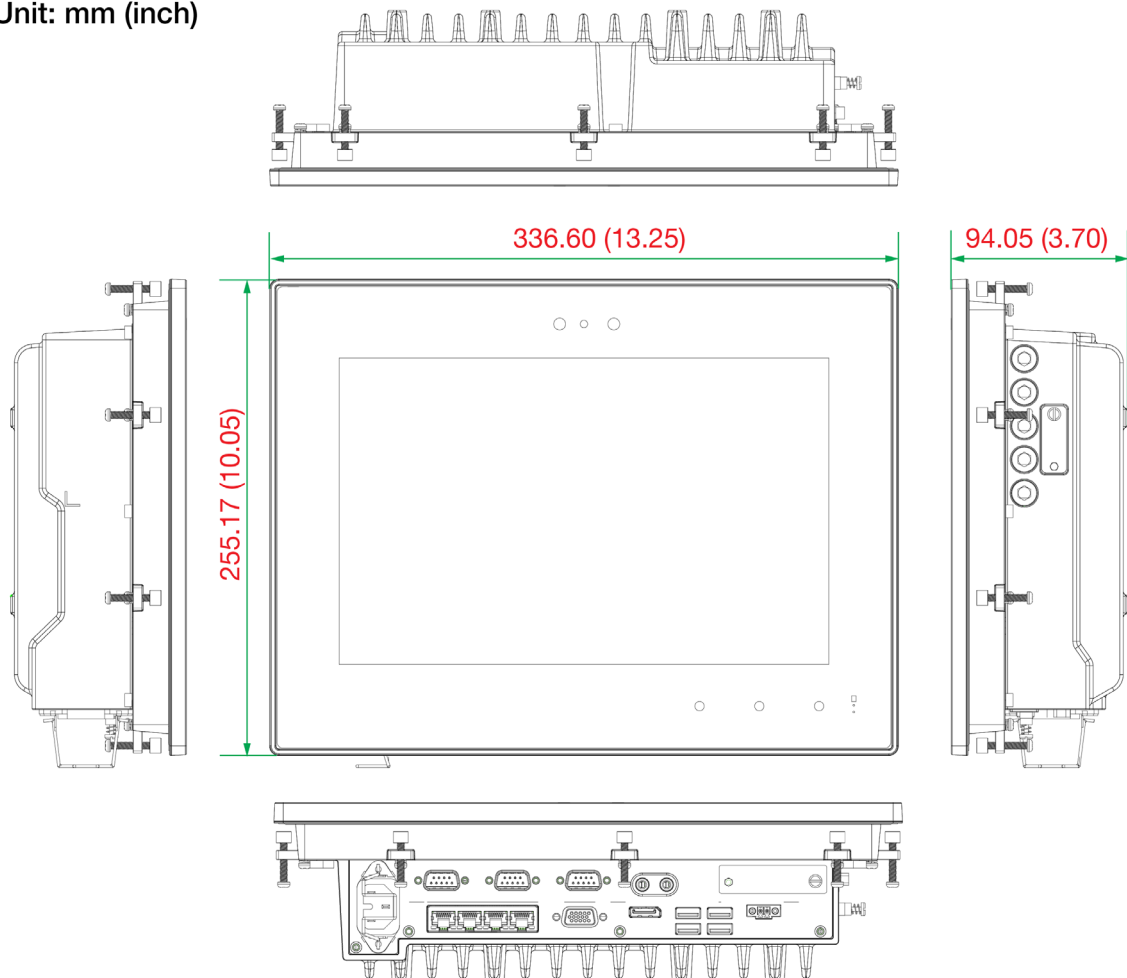

EXPC-F2150W Series

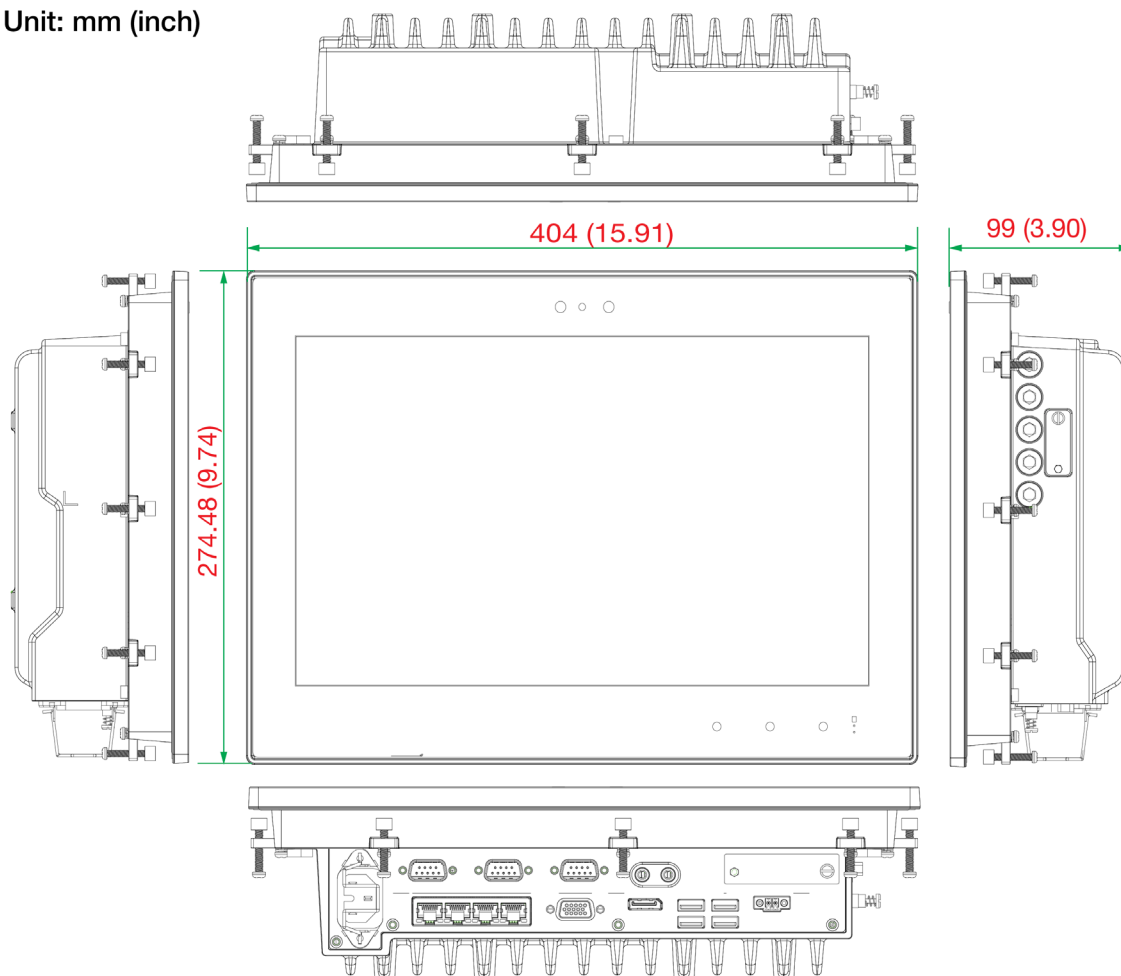

Unit: mm (inch)



Touch Panel Buttons and LEDs

The panel computers should be powered ON and functioning properly before the touch function buttons can be activated. To protect the function button against accidental activation, the buttons must be pressed twice; first time to enable the touch button area (the LED lights on the three buttons will light up) and second time to activate the function. Refer to the following table to learn how to use the display control buttons.

Button/LED	LED Status	Function Description
Functional Button  Combines power on/off and touch enable/disable functions	LED (white): When the system is powered off (S5 state), the Function button is clear white (not lit with any color). LED (Green): When the system is powered on (S0 state) and on tapping the touch keypad, the function button will turn green for 5 sec.	The Function button can be used to activate three functions configured using settings in the BIOS or a Moxa utility. The default function is that of the Power button. When in S5 state, the button is forced to function as a Power button to ensure the system can be powered on through the keypad. Function 1: Power Button: <ul style="list-style-type: none"> When the system is in S0 state, press the button for 3 seconds to power off the system (normal shutdown process), or display on/off, depending on the power management settings in the OS When the system is in S0 state, press the button for 6 seconds to force a hard shutdown of the system When the system is in S5 state, press the button for 1 second to power on the system

Button/LED	LED Status	Function Description					
		<p>Function 2: Enable/disable the Touch Function The touch function is enabled by default. After the function button is assigned to the touch function, press the button to enable or disable the function.</p> <p>Function 3: Customized function based on files stored in specified folders Use the built-in configuration utility to assign a specific folder for the quick start and running configuration files.</p>					
<p>Increase Brightness</p> 	<p>S0: LED (White): When the system is powered on (S0 state), touching the keypad button will light up both the Increase Brightness and Decrease Brightness button White LEDs for 5 secs.</p>	<p>Auto Mode 1: Light sensor is enabled and will automatically detect the ambient light sources to adjust the LCD brightness.</p> <p>Auto Mode 2: Light sensor is enabled as normally, but the brightness adjustment is still available, the light sensor will turn to "manual mode" when you press the "+/-" button, which is only available during 30 seconds after which it goes back to auto light sensor setting.</p> <p>Manual Mode: Auto light sensor is disabled. The brightness can be configured using the brightness button "+/-". The brightness level setting can be adjusted from 0 to 10.</p>					
<p>Decrease Brightness</p> 			Storage LED	Green	Indicates the access to storage (SSD only)	LED1	<p>LED1 and LED2 can be configured as LAN ports or serial ports using settings in the BIOS or a Moxa utility.</p> <p>LED1 is set to UART1 Rx by default LED2 is set to LAN1 by default</p> <p>When an LED is configured for a LAN port, its color indicates the following: Green: 100M speed Yellow: 1GB speed</p> <p>When an LED is configured for a serial port, its color indicates the following: Green: TX Yellow: RX</p>
Storage LED	Green	Indicates the access to storage (SSD only)					
LED1	<p>LED1 and LED2 can be configured as LAN ports or serial ports using settings in the BIOS or a Moxa utility.</p> <p>LED1 is set to UART1 Rx by default LED2 is set to LAN1 by default</p> <p>When an LED is configured for a LAN port, its color indicates the following: Green: 100M speed Yellow: 1GB speed</p> <p>When an LED is configured for a serial port, its color indicates the following: Green: TX Yellow: RX</p>	<p>Programmable LEDs to monitor serial or Ethernet communications.</p> <p>Ethernet Ports: 1 to 4 (100M/1G)</p> <p>Serial Ports: 1 to 3 (TX, RX)</p>					
LED2							

3. Hardware Connection Description

In this chapter, we show how to connect the panel computer to the network and to various devices.

Installing the EXPC-F2000W Panel Computers

Notes on Installing and Mounting

Before installing and mounting the EXPC-F2000W panel computer, please read the following notes:

1. The EXPC-F2000W panel computer is designed for various installation/mounting methods such as wall mounting and VESA mounting. Refer to the relevant mechanical drawings in the following sections before attempting to mount the panel computer.
2. It is advised that good ventilation is necessary to prolong the computer's lifespan. The chassis' heat-sink area **MUST** be kept clear from other heat-generating items, as this may damage the system motherboard. The minimal distance is 150 mm.
3. Allow sufficient physical space for proper ventilation, cable connectors, wiring passage, and practical maintenance purposes.
4. **DO NOT** install the unit in a horizontal position (laying down), as the heat inside of the unit is not dissipated effectively and will damage the LCD panel. It is recommended to install the unit in a vertical position (± 30 degrees) for better heat dissipation.
5. Exposure to extreme direct sunlight may cause a considerable increase in the temperature of the unit, and under certain circumstances might lead to overheating. Please take this point into consideration when the bridge equipment is being planned (sunshades, distance from the windows, ventilation, etc.)
6. Exposure to strong vibration or acoustic noise might affect the functionality and expected lifetime of the computer. Take consideration of these factors during system assembly and installation, to ensure the mounting position avoids exposure to strong vibrations.
7. For maximum safety, at least two people should work together to lift, place, and fasten the computer to its mounting point. Before you lift or move the computer, first verify the computer is disconnected from any power source and turned off. In addition, make sure you have prepared the correct screws for wall mounting.

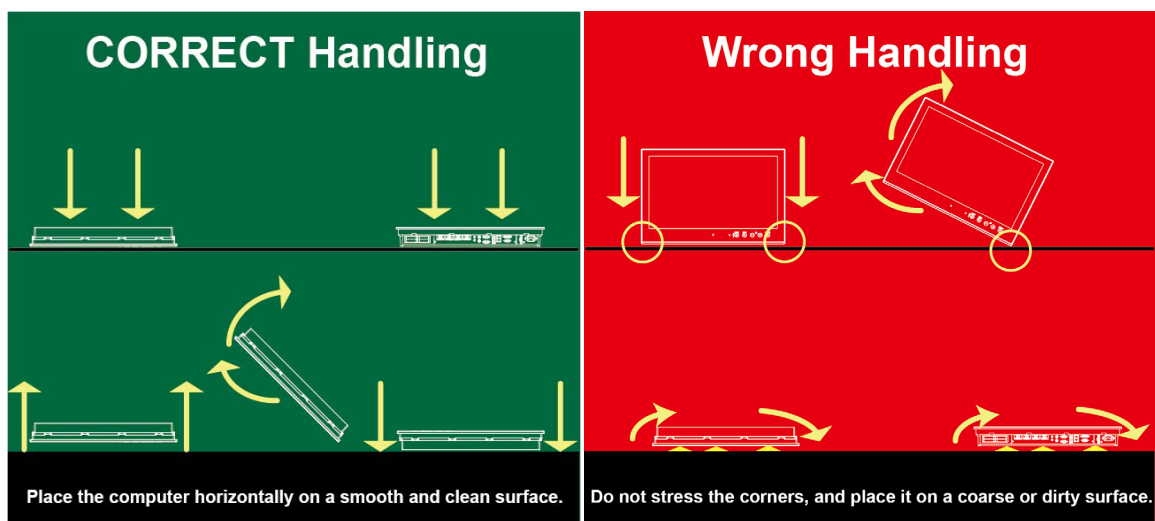



NOTE

To ensure secure and safe installation, we highly recommend that the mounting of the computer is done by a skilled person with experience of installing devices.

Panel Mounting

A panel-mounting kit is included in the package of the EXPC-F2000W panel computers, which includes 10 mounting clamps for EXPC-F2120W Series and 13 mounting clamps for EXPC-F2150W Series.

The panel-mounting kit enables installation onto a wall (where space has been cut out to accommodate the rest of the hardware) or on to computing stations where a flush mount is desired.

The surface to which the computer is clamped to can have a maximum thickness of 11 mm. For a secure mounting, all 10 or 13 clamps must be used. The clamp arms are fastened into slots on all four sides of the panel computer. Refer to the following figures for the panel mounting dimensions.

EXPC-F2120W Series

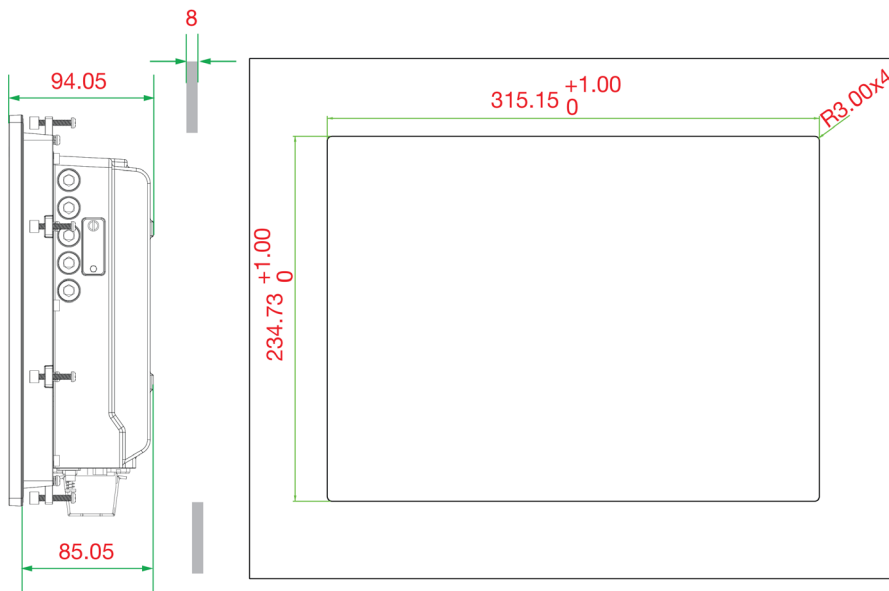

EXPC-F2150W Series

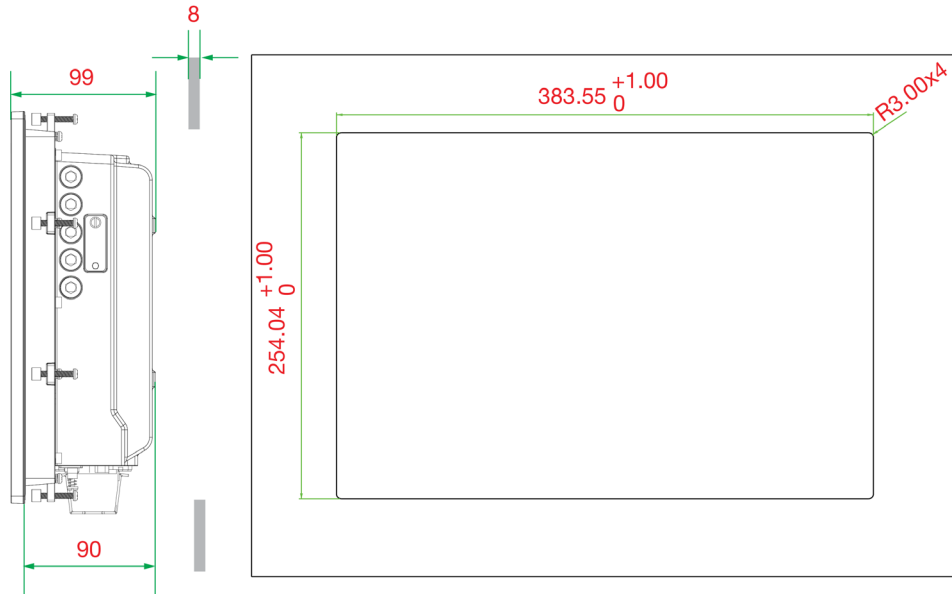

To install the mounting clamps:

1. Use short M4 SUS stainless-steel screws (included in the panel-mounting kit) to fasten the clamp arms to the EXPC-F2000W mounting slots, as shown in the diagram below.
2. Use the clamps to fasten the computer to its mounting point. The torque value should not exceed 5 kgf.

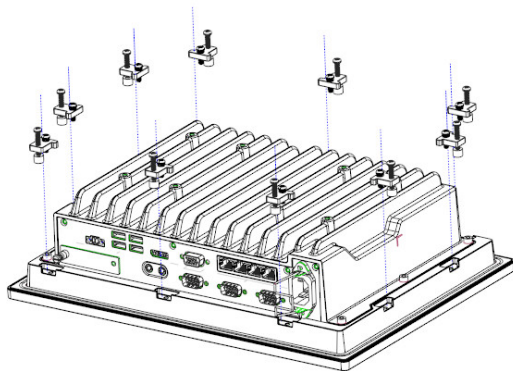

Screw M4 SUS with Spring Washer and Flat Washer
(Fixed Torque Needed: 5 kg)

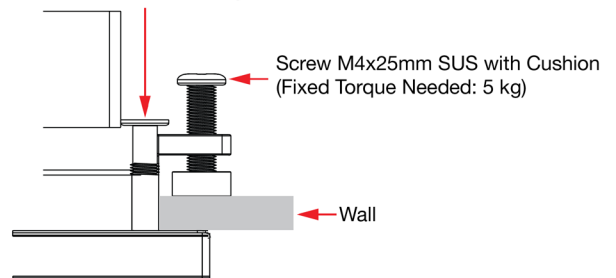

Mounting Kit Section

VESA Mounting (optional)

You can use an optional VESA mounting kit to install the EXPC-F2000W. Eight screws are required to fasten the VESA mounting bracket and must be purchased separately. Refer to the following figures for the VESA mounting dimensions for the EXPC-F2000W panel computers. Attach the bracket on the rear of the computer as shown in the following illustration:

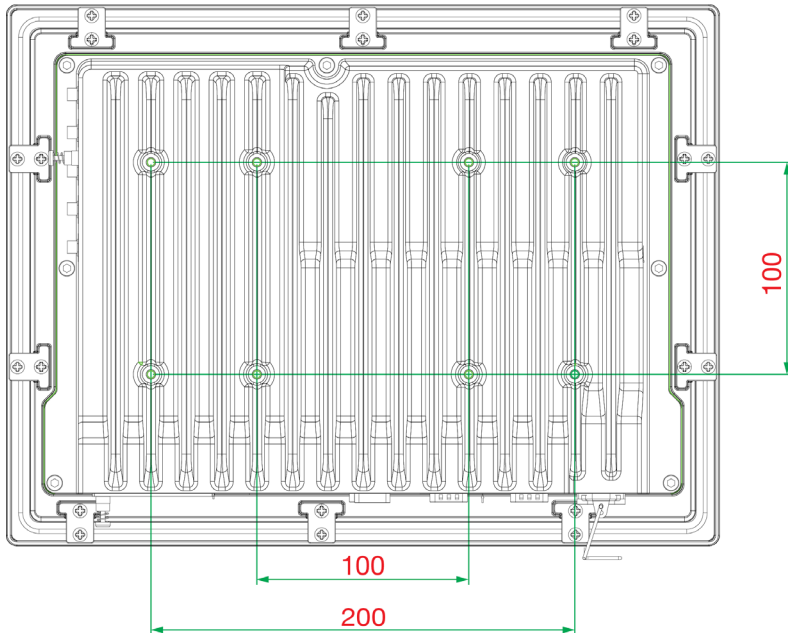

The detailed screw specifications and torque value are shown below:

Round screw M4x10mm SUS (Torque: 5.5 kgf-cm)

Wiring Requirements

This section describes how to connect peripheral devices to the panel computer.

You should read and follow these common safety precautions before proceeding with the installation of any electronic device:

- Use separate paths to route wiring for power and devices. If power wiring and device wiring paths must cross, make sure the wires are perpendicular at the intersection point.



NOTE

Do not run signal or communication wiring together with power wiring in the same wire conduit. To avoid interference, wires with different signal characteristics should be routed separately.

- Use the type of signal transmitted through a wire to determine which wires should be kept separate. The rule of thumb is that wiring that shares similar electrical characteristics can be bundled together.
- Keep input wiring and output wiring separate.
- It is advisable to label the wiring to all devices in the system.



ATTENTION

Safety First!

Be sure to disconnect the power cord before installing and/or wiring your EXPC-F2000W panel computer.

Wiring Caution!

Calculate the maximum possible current in each power wire and common wire. Observe all electrical codes dictating the maximum current allowable for each wire size.

If the current goes above the maximum ratings, the wiring could overheat, causing serious damage to your equipment.

Grounding

Proper grounding and wire routing help to limit the effects of noise from electromagnetic interference (EMI). Run the ground connection from the ground screw to the grounding surface prior to connecting the power source. For the DC models, run a connection from the functional earthing screw (M6) to the grounding surface. The grounding wire should have a minimum diameter of 1.5 mm².

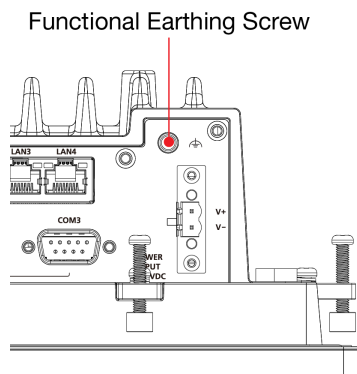

Temperature Requirements

Be careful when handling the unit. When the unit is plugged in, the internal components generate heat, and consequently the outer casing may feel hot to the touch.

- We recommend taking the following precautions to minimize heat build-up within the display:
- Position the display within $\pm 40^\circ$ of the vertical.
- Install an external fan to increase airflow upwards through the display if (a) the display is not positioned within $\pm 40^\circ$ of the vertical, (b) the ambient temperature exceeds 25°C, or (c) the display is used in a location with minimal ventilation.

Powering On/Off the EXPC-F2000W

To power on the EXPC-F2000W panel computer, you can either supply the power by connecting the terminal-block-to-power-jack converter to the terminal block and then connecting a power adapter or connect the computer to an AC power source using the power cord. After the power source is connected, the panel computer will boot automatically. It takes about 10 to 30 seconds for the system to boot up.

To power off the EXPC-F2000W, touch the function button once and push for 3 seconds. Depending on the OS's power management settings the panel computer may enter **Display On/Off** or **Power On/Off** mode. If you encounter technical problems, touch the function button once, and push for 6 seconds to force a hard shutdown of the system.

Power input sockets are located on the bottom view of the computers.

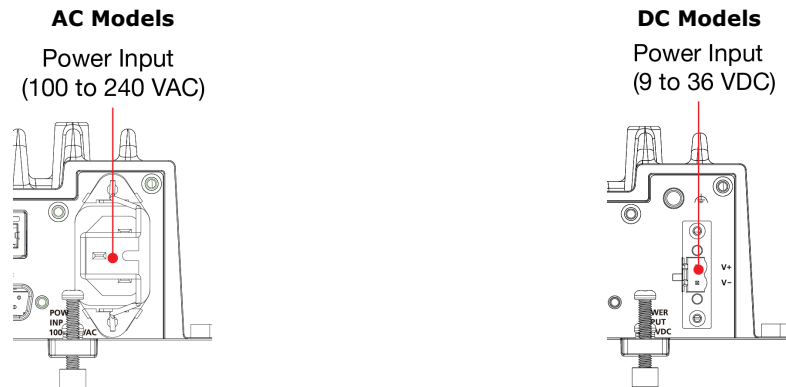

When using AC power, first ensure that you connect the AC power cord to a socket-outlet with earthing connection and use the standard C16 AC inlet along with a C15 plug (refer to the figure in the "Powering On/Off the EXPC-F2000W" section) or standard C15 plug with AC adapter cable. When using DC power, use at least a 100 W power adapter connected through the 2-pin terminal block in the accessories package. The pin assignments for the DC models are shown in the following diagram:

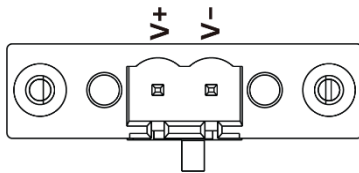

A terminal block is available in the accessories package. The required wire size is 12-14 AWG (Wire Type: Cu, Field Wiring: 2) and a torque value 0.5 N-m (4.5 lb-in) should be applied. The input terminal block should be wired and installed by a skilled person.



ATTENTION

This equipment is intended to be supplied by an external power source, which is evaluated according to UL/EN/IEC 62368-1 or UL/IEC 60950-1. It shall comply with ES1/SELV requirements such as output rating 9 to 36 VDC, 11 A (min.), an ambient temperature of 70 degrees C minimum for DC power construction of EXPC-F2000W series. If you are using a Class I adapter, the power cord should be connected to an outlet with an earthing connection.

For a secure installation, we recommend using a C15 plug with the following dimensions:

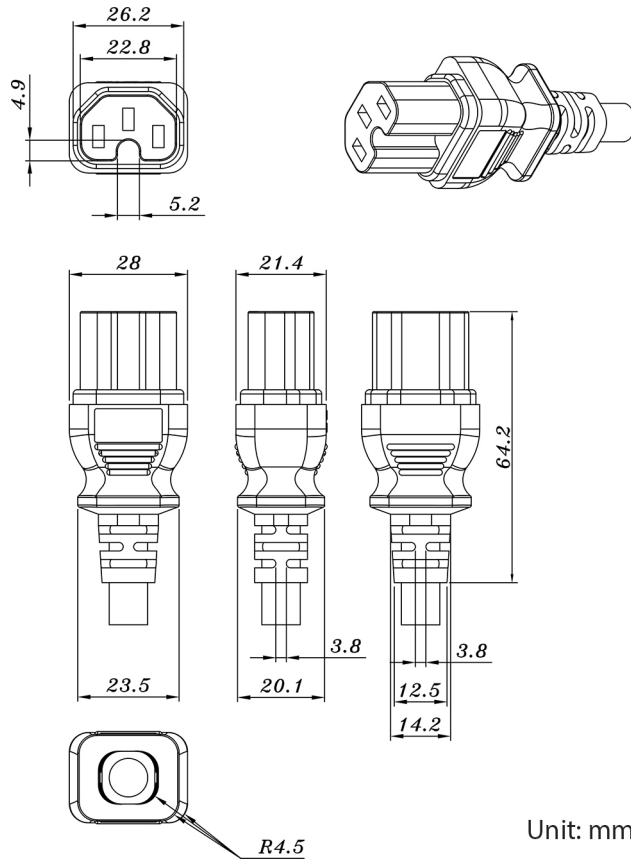

Touch Panel Buttons and LEDs

The EXPC-F2000W panel computer comes with three OSD control buttons and three LED indicators located on the front panel as indicated in the illustration. These intelligent controls will light up when you move your hand over their location.

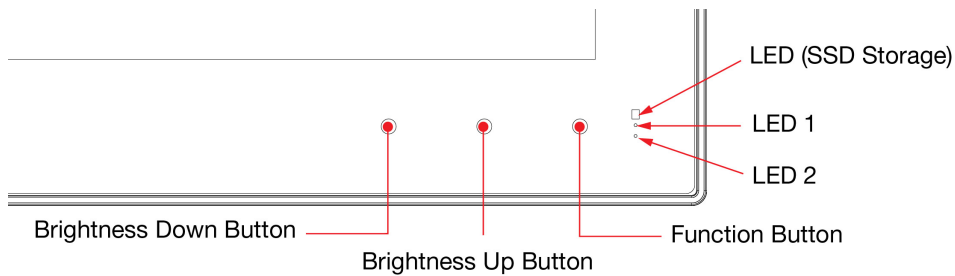

Brightness Button

Two brightness buttons are available for brightness control. Press the **Brightness Up** button to increase the brightness of the panel, and the **Brightness Down** button to decrease the brightness.

Function Button

This is a programmable button that users can define to fit their applications. It may be used to power on/off the computer, or other functions by software settings.

LED (SSD storage only)

A storage icon can also be found on the panel. When data access occurs, it will display a blinking red status.

LED 1/LED 2

These two LED indicators are programmable; users may use them with their requirements.

Extending the Displays

The EXPC-F2000W comes with both standard VGA (DB15) and interfaces on DisplayPort the bottom surface. They may be used simultaneously to extend the display across two monitors. See the following figures and tables for the location and pin assignments for the display outputs.

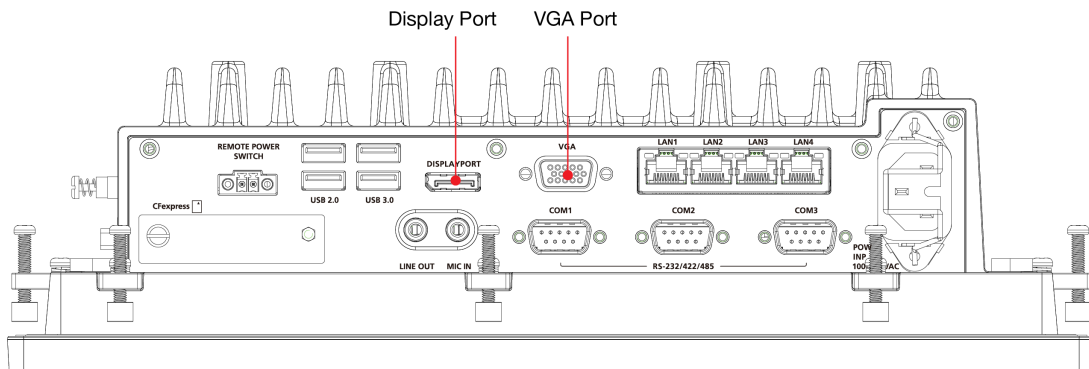

DB15 Female Connector

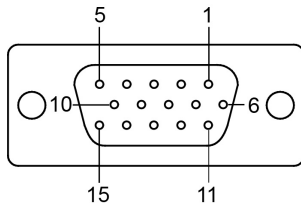

Pin No.	Signal Definition
1	Red
2	Green
3	Blue
4	NC
5	GND
6	GND
7	GND
8	GND

Pin No.	Signal Definition
9	VCC
10	GND
11	NC
12	DDC2B Data
13	HSYNC
14	VSYNC
15	DDC2B Clock

Connecting Data Transmission Cables

This section describes how to connect the EXPC-F2000W panel computer to a network, or serial devices.

Connecting to a Network

Plug an Ethernet cable into the EXPC-F2000W's Ethernet port. The other end of the cable should be plugged into your Ethernet network. When the cable is properly connected, the LEDs on the panel computer's Ethernet port will glow to indicate a valid connection. See the following figure for the location of the Ethernet ports.

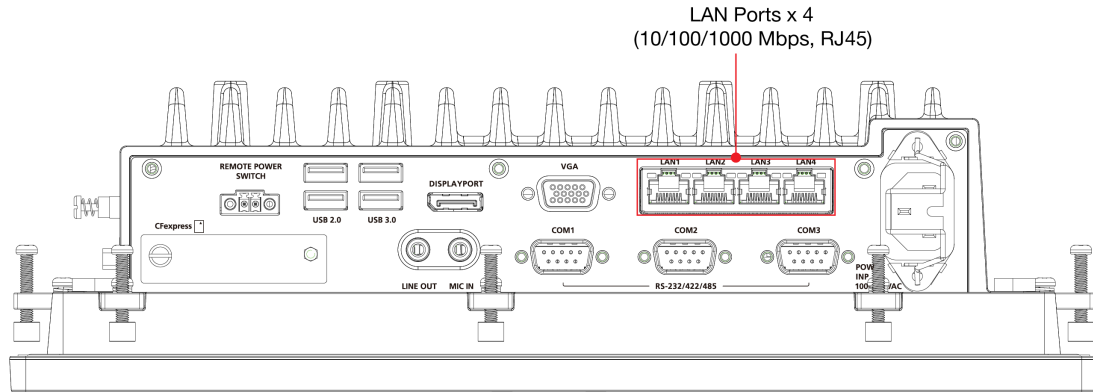

The 10/100/1000 Mbps Ethernet LAN port uses 8-pin RJ45 connectors. The following diagram shows the pinouts and the descriptions for these ports.

LAN (on connectors)	Green	100 Mbps Ethernet mode
	Yellow	1000 Mbps (Gigabit) Ethernet mode
	Off	No activity or 10 Mbps Ethernet mode

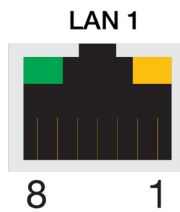

Pin	100 Mbps	1000 Mbps
1	ETx+	TRD(0)+
2	ETx-	TRD(0)-
3	ERx+	TRD(1)+
4	-	TRD(2)+
5	-	TRD(2)-
6	ERx-	TRD(1)-
7	-	TRD(3)+
8	-	TRD(3)-

Connecting to a Serial Device

Use a serial cable to plug your serial device into the EXPC-F2000W's serial ports. These ports have male DB9 connectors and can be configured for RS-232, RS-422, or RS-485 communication by software. See the following figure for the location of the serial ports.

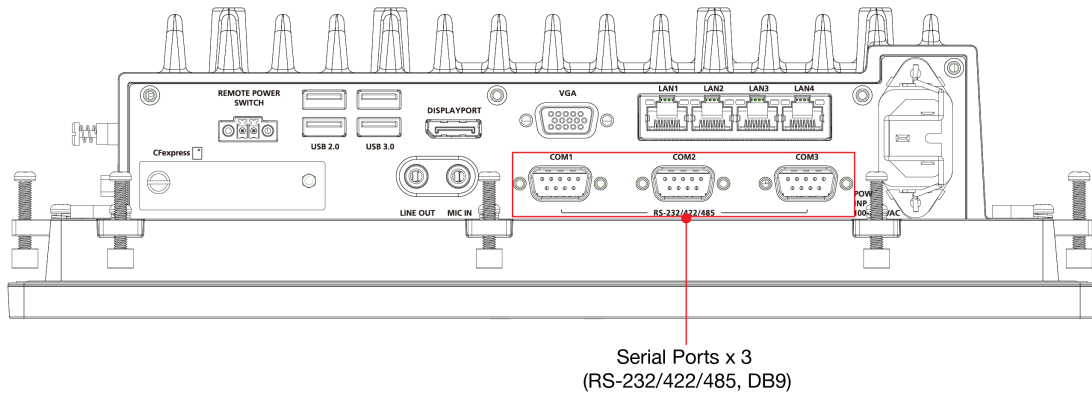

The pin assignments are shown in the table at the top of the next page:

DB9 Male Port

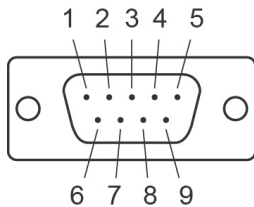

RS-232/422/485 Pinouts

Pin	RS-232	RS-422	RS-485 (4-wire)	RS-485 (2-wire)
1	DCD	TxDA(-)	TxDA(-)	-
2	RxD	TxDB(+)	TxDB(+)	-
3	TxD	RxDB(+)	RxDB(+)	DataB(+)
4	DTR	RxDA(-)	RxDA(-)	DataA(-)
5	GND	GND	GND	GND
6	DSR	-	-	-
7	RTS	-	-	-
8	CTS	-	-	-

The serial ports are referred to by different names as indicated in the following table:

Device Label	BIOS	Utilities	Windows	Linux
COM1	UART1	UART1	COM3	/dev/USB1
COM2	UART2	UART2	COM4	/dev/USB2
COM3	UART3	UART3	COM5	/dev/USB3

Connecting to a Speaker or a Headphone

The EXPC-F2000W comes with line-out and mic-in interfaces for connecting a microphone and either speakers or headphones. See the following figure for the location.

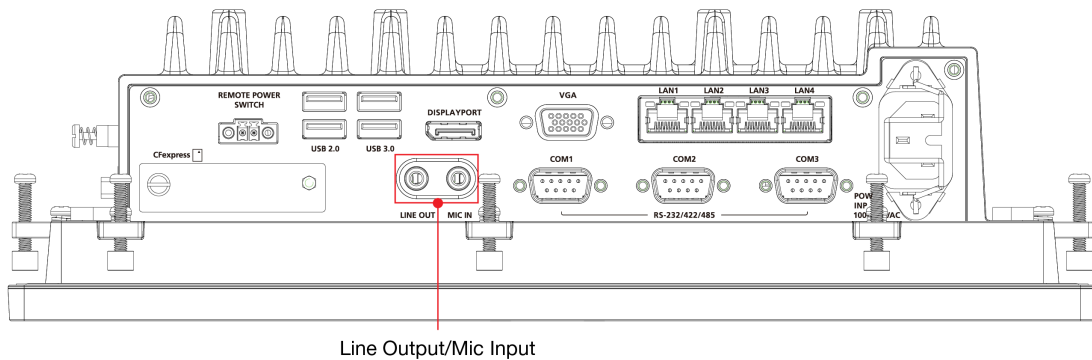

Connecting to USB Devices

The EXPC-F2000W comes with 2 USB 2.0 ports and 2 USB 3.0 ports with type A on the computer. The ports can be used for an external flash disk or hard drive for data storage expansion. You can also use these USB ports to connect to a keyboard or a mouse.

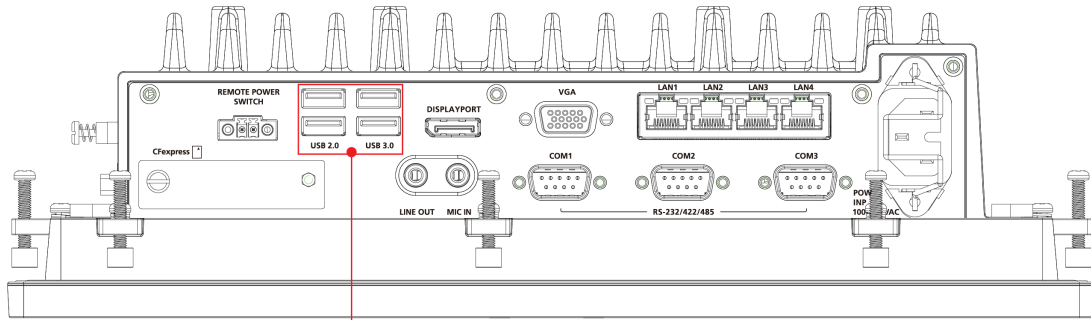

USB Hosts x 2 (USB 2.0, type A)
USB Hosts x 2 (USB 3.0, type A)



NOTE

To comply with the standard of IP42, all connectors and interfaces must be fully plugged in.

Installing Additional Storage: SSD

The EXPC-F2000W panel computer comes with 2 storage slots: A CFexpress slot located on the bottom panel for easy installation and maintenance and an **M.2 B Key** slot (**SATA 3.0**) located inside the computer, allowing users to install the second storage with an SSD to fit the applications. The SSD should be of type **M.2 2242 B-M**.

If you want to install or replace an SSD, do the following:

1. Fasten these seven screws on the back of the computer.

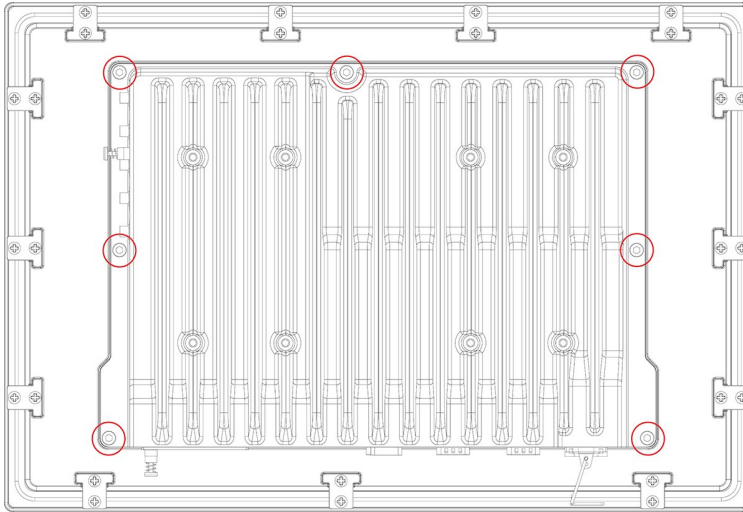

2. Take off the back component of the computer from the panel and remove these ten screws.

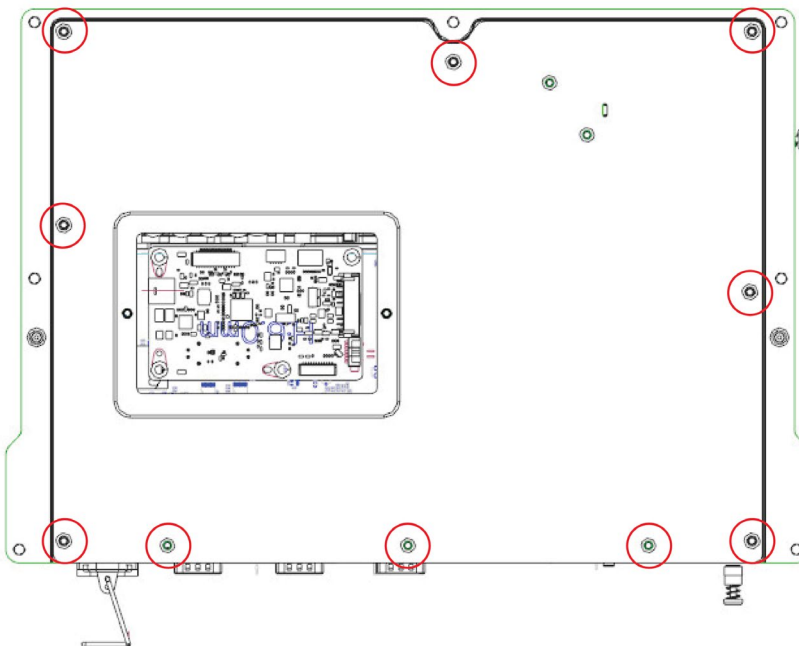

3. Take off the cover and check the location of the SSD socket.

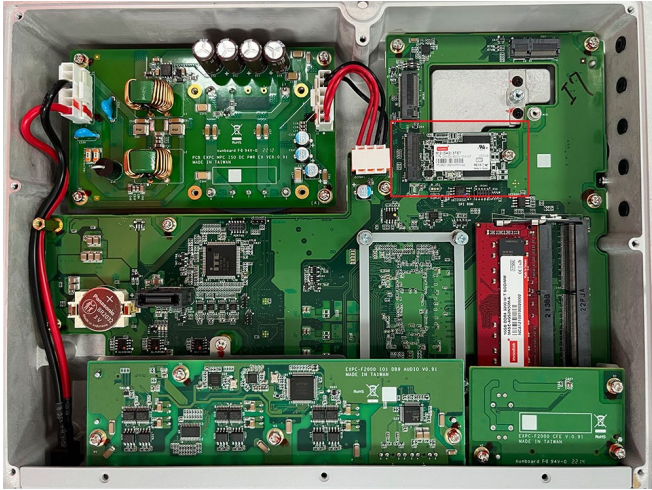

4. If the SSD has already been installed, remove the screw on the end, and remove the SSD.

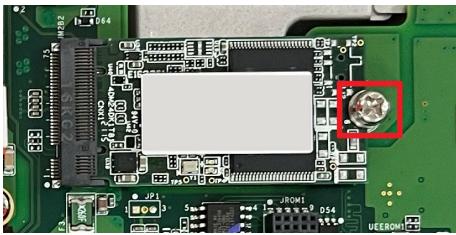

5. Insert an SSD card into the socket or replace the existing one.

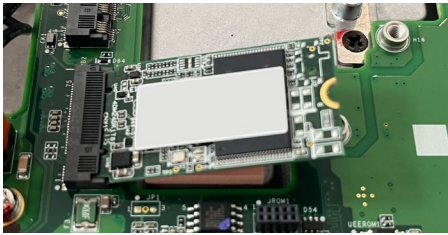

6. Fasten the SSD card in place and secure it by fastening the screw on the socket.

Installing a CFexpress Card

The EXPC-F2000W has one CFexpress slot with a PCIe 3.0 interface. Users install a standard CFexpress card using a push-push mechanism. For a list of compatible CFexpress cards contact Moxa technical support team.

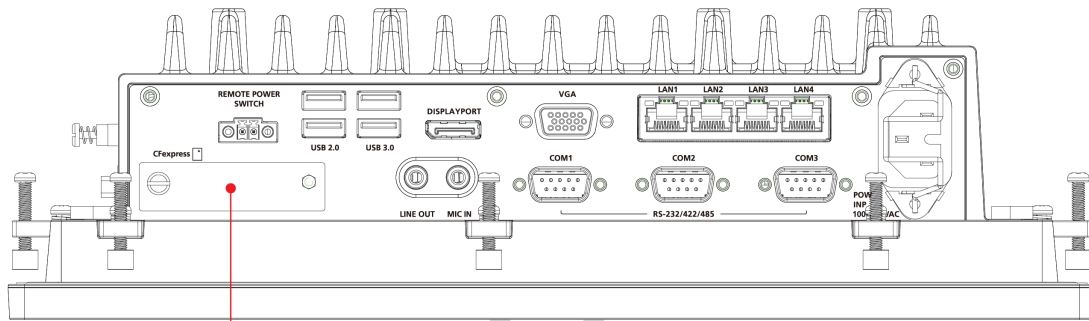

CFexpress Socket Cover

To install a CFexpress card, do the following:

1. Loosen the screws on the CFexpress slot cover.

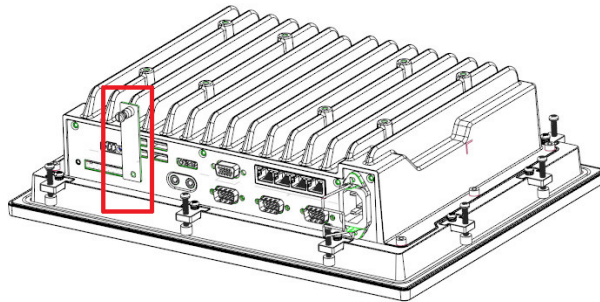

2. Slide the cover to access the slot and insert the CFexpress card into the slot and push it all the way into the slot.

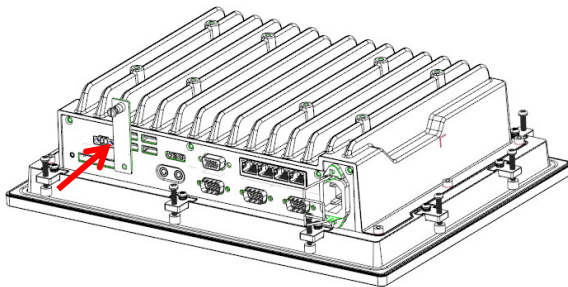

- To remove the card, you need to push the card in to release the card.
3. Put back the CFexpress slot cover and tighten the screws to secure it.

Real-time Clock

The real-time clock (RTC) is powered by a lithium battery. We strongly recommend that you do not replace the lithium battery without help from a qualified Moxa support engineer. If you need to change the battery, contact the Moxa RMA service team at http://www.moxa.com/rma/about_rma.aspx.



ATTENTION

There is a risk of explosion if the clock's lithium battery is replaced with an incompatible battery.

4. BIOS Setup

In this chapter, we describe the BIOS settings for the EXPC-F2000WMC-3201 computer. The BIOS is a set of input/output control routines for peripherals to initialize the basic settings. The BIOS helps boot the system before the operating system is loaded. The BIOS setup allows the user to modify the system configuration for basic input/output peripherals. All configurations are stored in the CMOS RAM, which has backup battery in case the computer is not connected to a power source. Consequently, the data stored in the CMOS RAM is retained when the system is rebooted, or the power is disconnected.

Entering the BIOS Setup Utility

To enter the BIOS setup utility, press the F2 key while the system is booting up. The main BIOS Setup screen will appear. You can configure the following settings on this screen.

- **Continue:** Continue to boot up
- **Boot Manager:** Select the device for boot up
- **Device Management:** Enter the device configuration menu
- **Boot From File:** Select the UEFI boot up file
- **Administer Secure Boot:** Enter the Secure Boot menu
- **Setup Utility:** Enter the BIOS configuration menu
- **Intel® Management Engine BIOS Extension:** Enter the AMT configuration menu (not supported in models with Intel® Celeron® and Core™ i3 processors)

Select **F2** to enter the **BIOS configuration**.

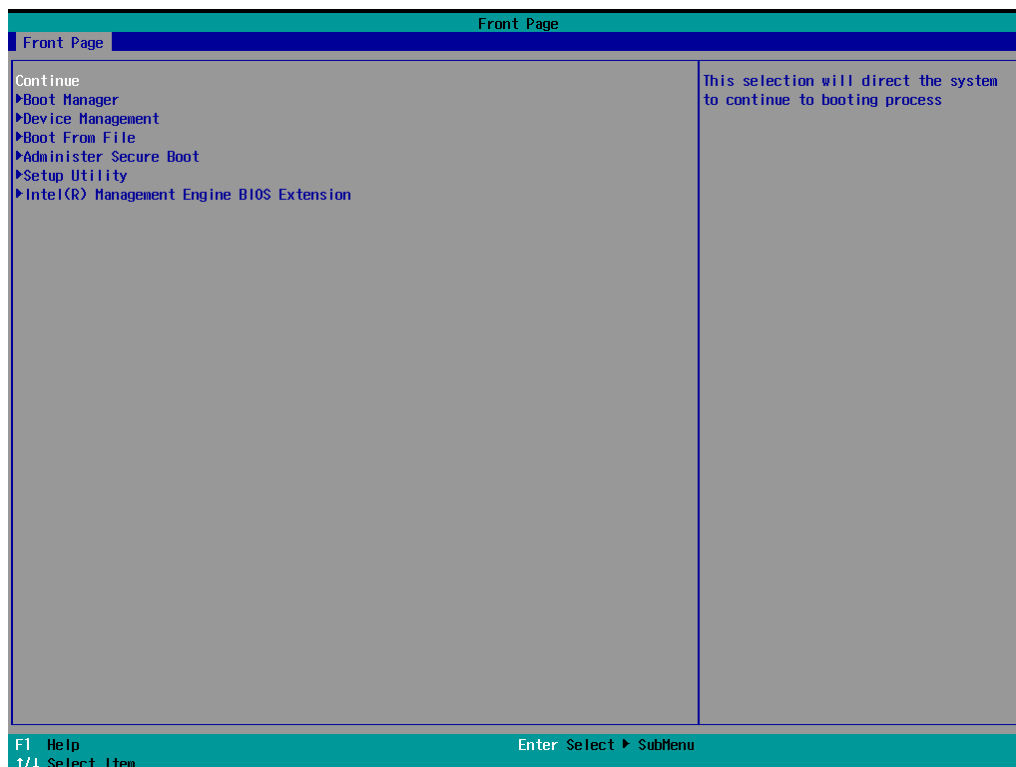

When you enter the **Setup Utility**, a basic description of each function key is listed at the bottom of the screen. Refer to these descriptions to learn how to use them.

F1	General Help	↑ ↓ .	Select Item
F5/ F6	Change Values	← →	Select Menu
F9	Setup Defaults	ESC	Exit
F10	Save and Exit	EN TER	Select or go to Submenu.

The BIOS configuration screen will be shown when you enter the **Setup Utility** option.

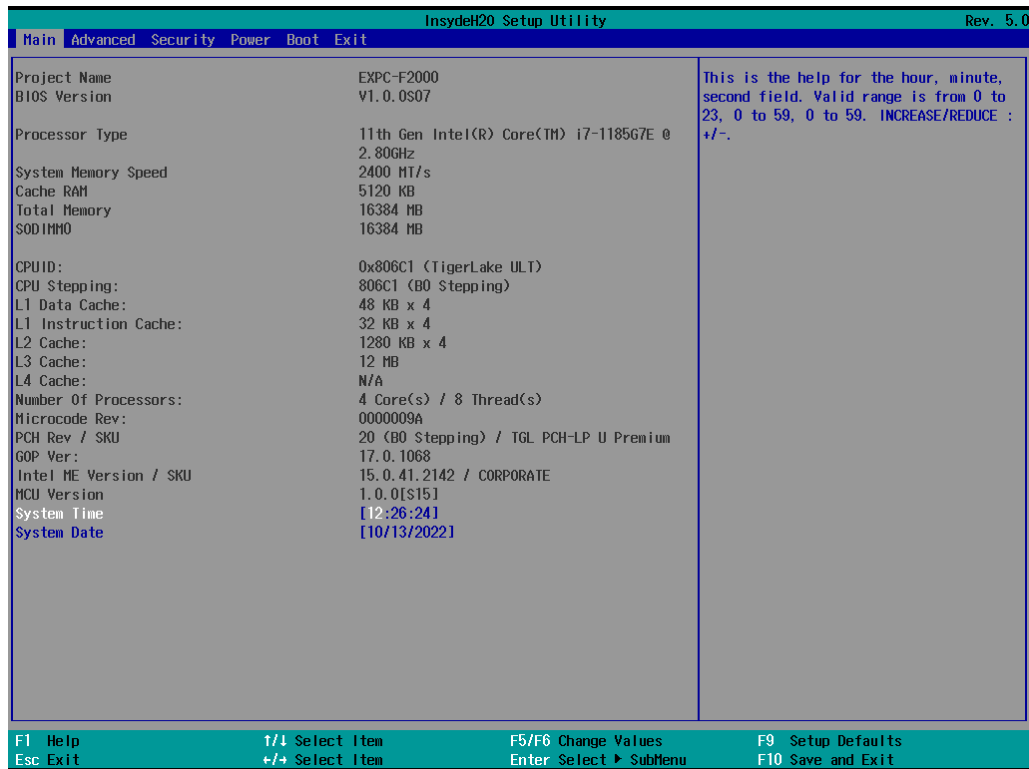

NOTE

The **Processor Type** information may vary depending on the model that you have purchased.

Main Page

The **Main** page displays basic hardware information, such as model name, BIOS version, and CPU type.

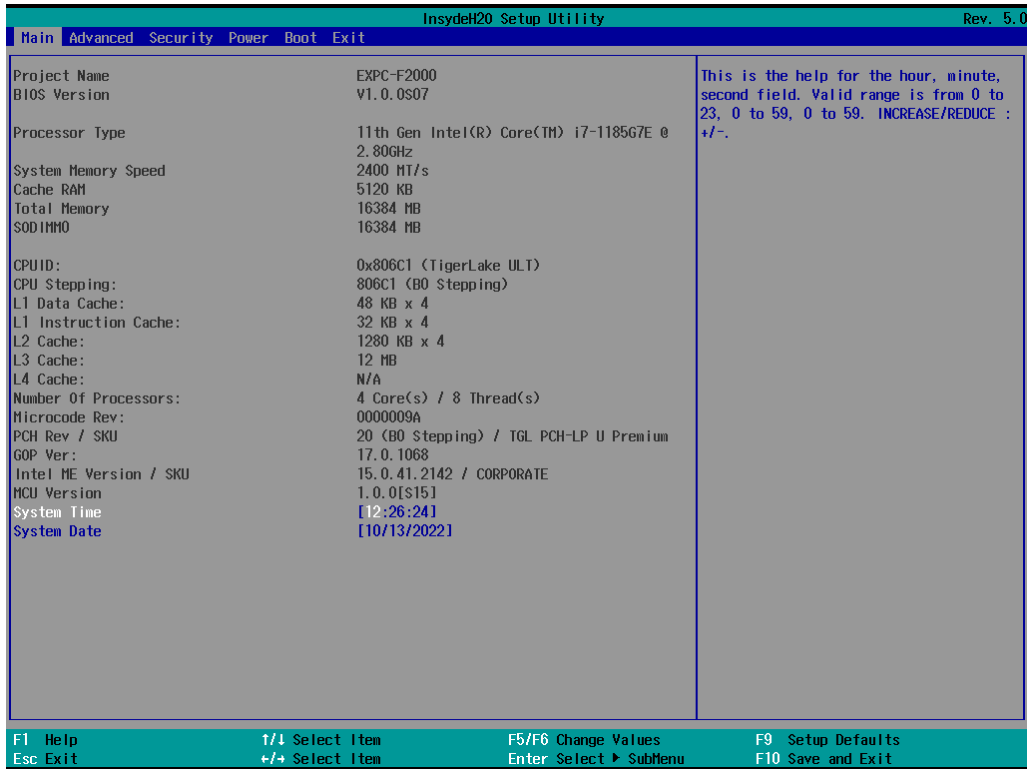

Advanced Settings

Select the **Advanced** tab in the main menu to open the advanced features screen.

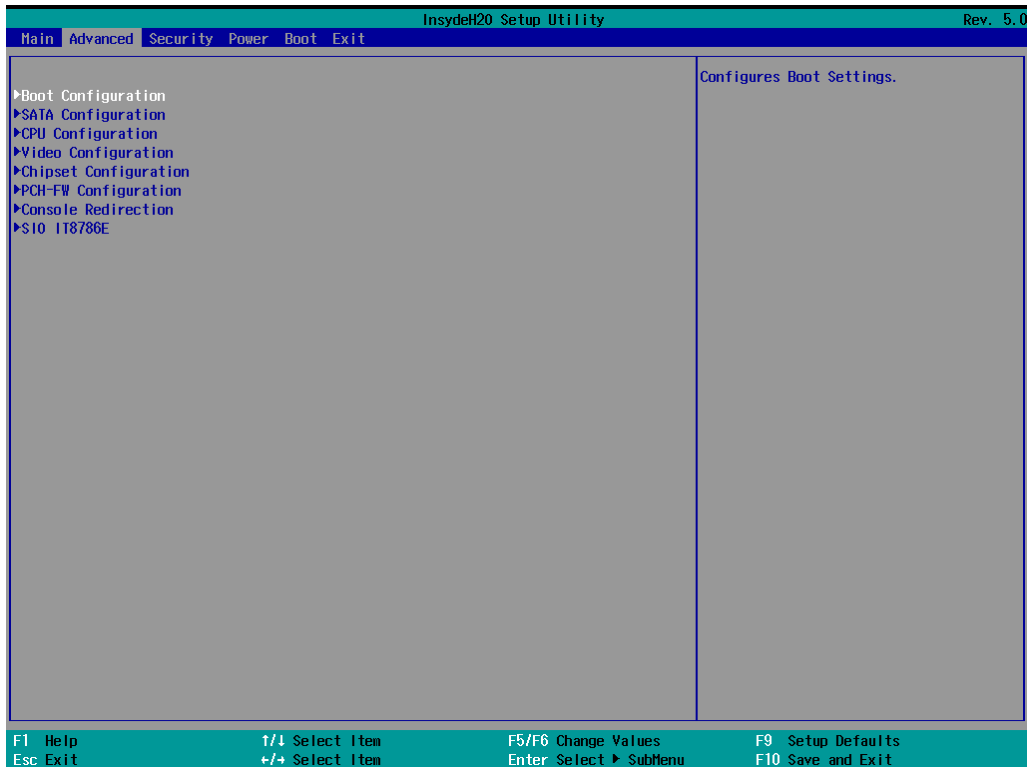

Boot Configuration

The **Numlock** option allows configuration of the Numlock value.

Options: On (default), Off.

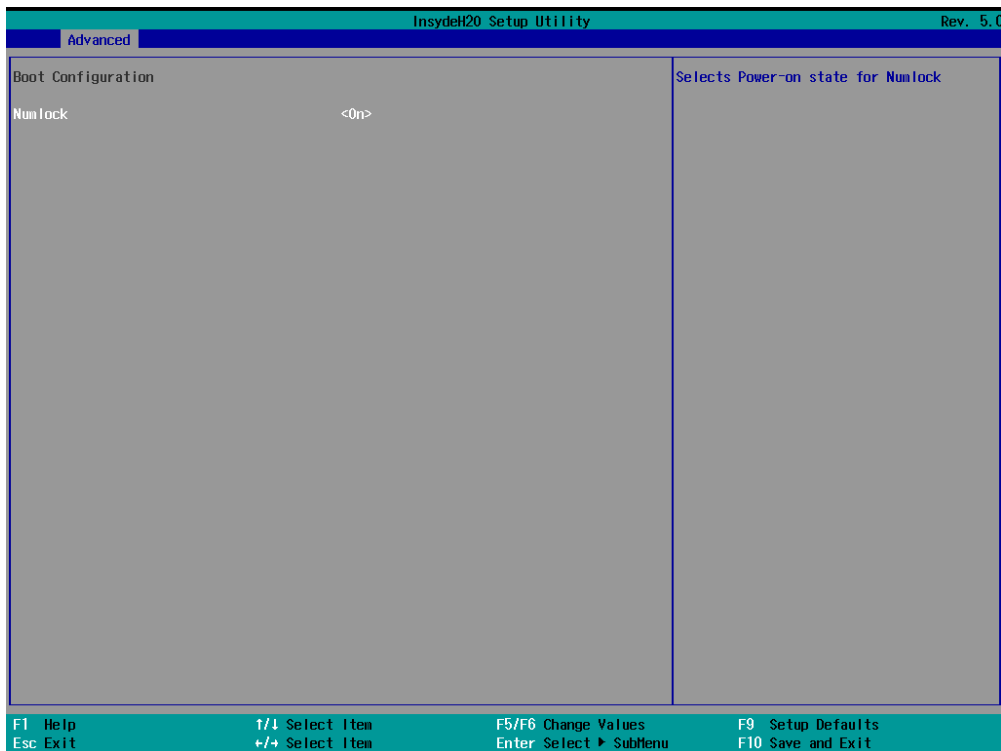

SATA Configuration

These items allow you to select the SATA speed limit and enable or disable the RAID mode.

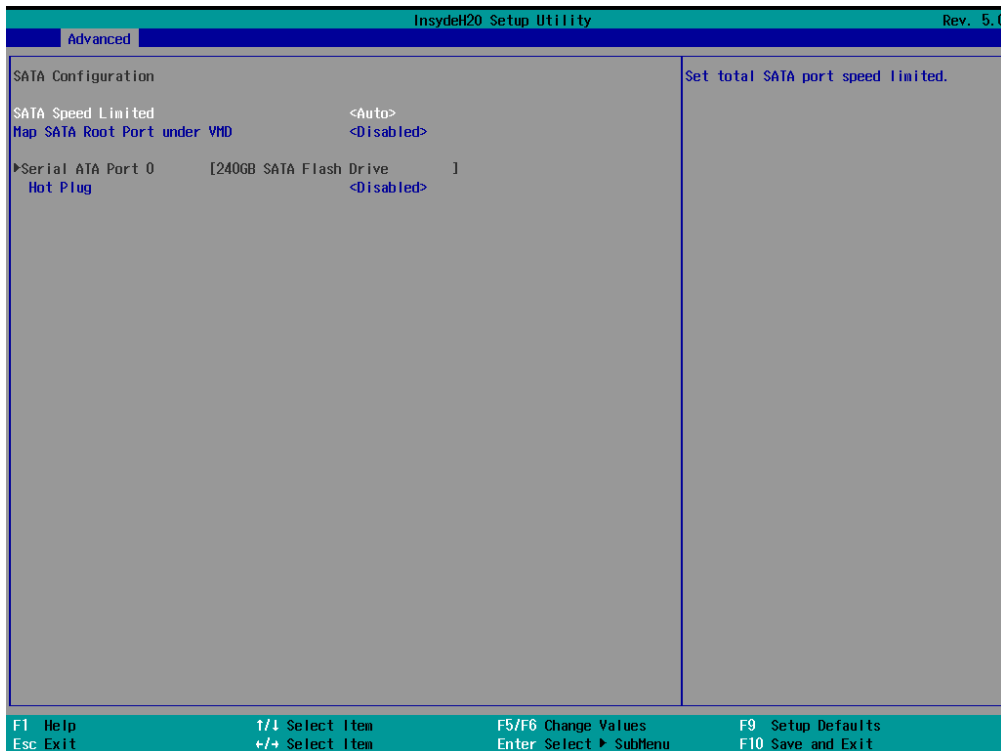

SATA Speed Limited

Options: Auto (default), Gen 1, Gen 2, Gen 3

Map SATA Root Port under VMD

Options: Disabled (default), Enabled

Serial ATA Port

This setting displays information on the installed drives.

SATA Port Hot Plug

This setting allows you to enable/disable hot-plugging capabilities (the ability to remove the drive while the computer is running) that are configured by software for installed storage drives.

Options: Disabled (default), Enabled

CPU Configuration

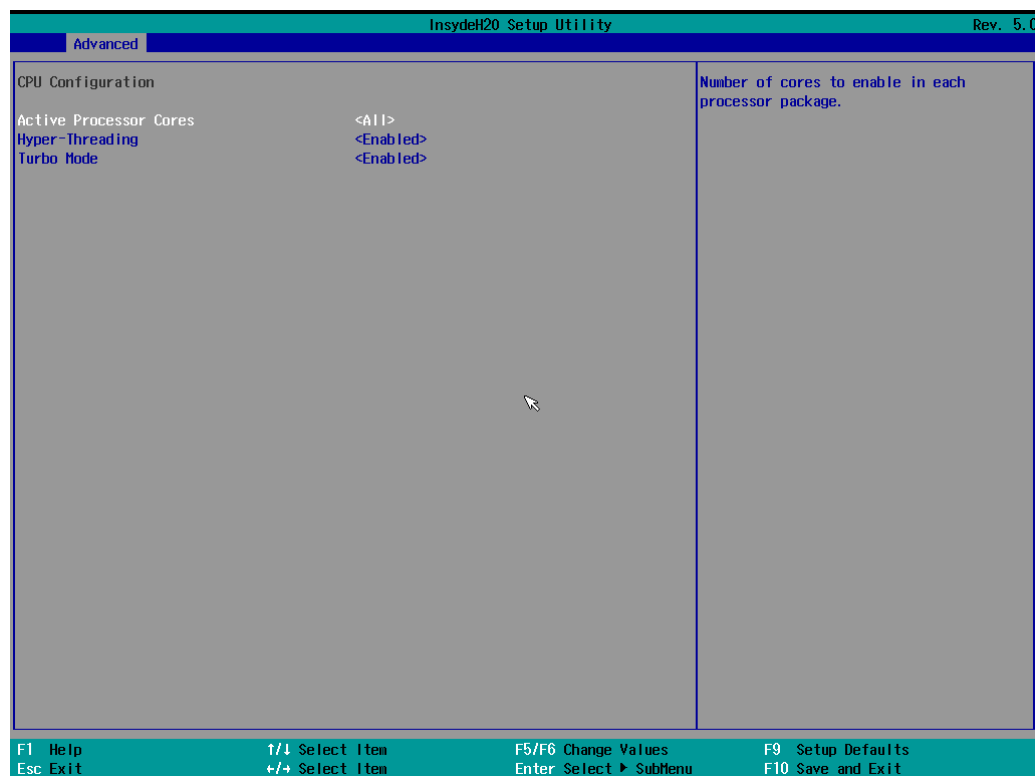

Active Processor Cores

This item indicates the number of cores to enable in each processor package.

Hyper-Threading

This feature makes the processor resources work more efficiently, enabling multiple threads to run on each core. It also increases processor throughput, improving overall performance on threaded software.

Options: Disabled, Enabled (default)

Turbo Mode

This function enables/disables Turbo mode in the processor.

Options: Disabled (default), Enabled



WARNING

When enabling the Turbo mode, make sure the power input is higher than 10 VDC.

Video Configuration

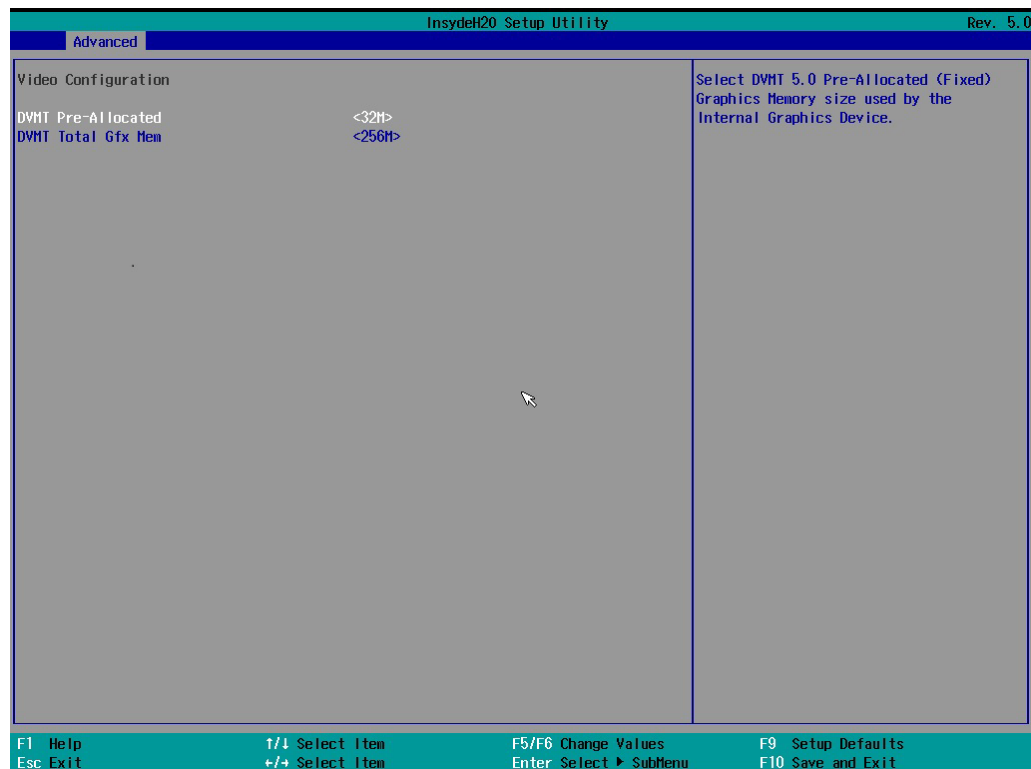

DVMT Pre-Allocated

This item allows you to configure pre-allocated memory capacity for the IGD. Pre-allocated graphics memory is invisible to the operating system.

Options: 32M (default), 96M, 128M, 160M

DVMT: The amount of video memory your computer has is dependent on the amount of pre-allocated memory set for your system plus the Dynamic Video Memory Technology (DVMT). DVMT dynamically allocates system memory for use as video memory creating the most efficient use of available resources for maximum 2D/3D graphics performance.

DVMT Total Gfx Mem.

This item allows you to configure the maximum amount of memory DVMT will use when allocating additional memory for the internal graphics device.

Options: 256 MB (default), 128 MB, Max.

Chipset Configuration

This item allows you to configure the chipset settings.

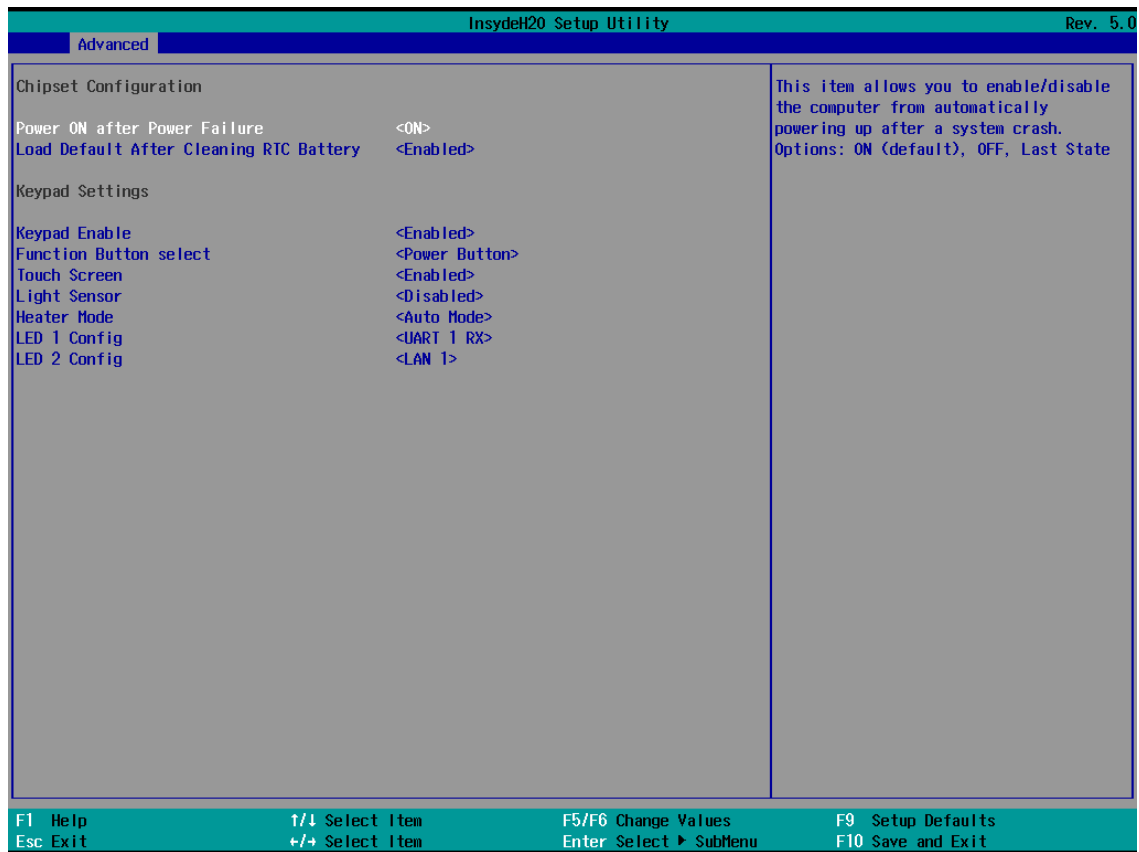

Power ON after Power Failure

This item allows you to enable/disable the computer from automatically powering up after system power is re-enabled.

Options: ON (default), OFF, Last State

Keypad Settings

Keypad Enable

Options: Disable, Enable (Default)

Touch keypad is enabled by default. When it is in the disabled status, the keypad buttons cannot be operated by the touch keypad.



NOTE

If keypad is set to be disabled, users need to use a mouse/keyboard to enable it again via the BIOS or a utility.

Function Button Select

Options: Power Button (Default), Touch Screen Button enable/disable Button, Customized Button

There are 3 modes for the keypad function button:

- The default setting is 'power button', which is to power on/off the computer.
- The 2nd mode is to enable/disable Touch screen function.
- The 3rd mode is a 'quick button' to run the specific program.

Touch Screen

Options: Disable, Enable (Default)

Touch screen function is enabled by default.

The touch screen function can be configured to be enabled or disabled. If it is set as disabled, users cannot use the touch screen function.



NOTE

The 'function button' and the 'touch button' work in a similar manner. If the touch screen is set as disabled, users need to use a mouse/keyboard to enable it again via the BIOS or a utility.

Light Sensor Mode Select

Options: Disable (Default), Auto Mode 1, Auto Mode 2

Disable: light sensor function is disabled, and brightness setting is set as 'Manual Mode' by keypad brightness buttons - / + or brightness assignment in utility.

Auto Mode 1: Automatically detect ambient light sources to adjust LCD brightness

Auto Mode 2: Both automatic brightness adjustment and manual brightness adjustment are enabled. The brightness can be adjusted using keypad buttons.

When the keypad buttons - / + are detected as active, the light sensor will be changed to "Manual Mode", users can adjust LCD brightness based on the keypad button settings. After 30 seconds when keypad buttons are not active, the brightness value will be stored as brightness assignment and then returns to Auto Mode.

Heater Mode

Options: Disable, Efficiency Mode, Auto Mode (Default)

Disable: Heater is always disable even when the temperature is lower than -30C, and the computer system will boot up normally.

Efficiency Mode: Heater will be enabled when the temperature is lower than -30 C, and heater will be enabled to heat up the LCM. The EXPC-F2120W computer will boot up normally no more than 3 minutes, EXPC-F2150W computer will boot up normally no more than 4 minutes.

Auto Mode: Heater function is in Auto Mode by default. Heater will be enabled when the temperature is lower than -30 C, and the heater will enable to heat up the LCM. The EXPC-F2120W computer will boot up normally no more than 8 minutes, the EXPC-F2150W computer will boot up normally no more than 14 minutes.



NOTE

When the heater is enabled to heat up the LCM, the function button of the white LED will blink.

LED 1 Source Select

Options: Disable, LAN 1, LAN 2, LAN 3, LAN 4, UART 1 TX, UART 2 TX, UART 3 TX, UART 1 RX (Default), UART 2 RX, UART 3 RX

It can be assigned as LAN ports or UART status. You should go to BIOS or utility to assign the LAN1 to LAN4 of LAN connections or assign to TX or RX for UART1 to UART3 ports.

Default is set as UART 1 RX.



NOTE

When configured as a LAN port, Green light means a transmission speed of 100 Mbps and Yellow light means 1 Gbps speed. When configured as a Serial port, Green light refers to TX and Yellow light refers to RX.

LED 2 Source Select

Options: Disable, LAN 1 (Default), LAN 2, LAN 3, LAN 4, UART 1 TX, UART 2 TX, UART 3 TX, UART 1 RX, UART 2 RX, UART 3 RX

It can be assigned as LAN ports or UART status. You should go to BIOS or utility to assign the LAN1 to LAN4 of LAN connections or assign to TX or RX for UART1 to UART3 ports.

Default is set as LAN 1.



NOTE

When configured as a LAN port, Green light means a transmission speed of 100 Mbps and Yellow light means 1 Gbps speed. When configured as a Serial port, Green light refers to TX and Yellow light refers to RX.

PCH-FW Configuration

This item allows you to configure the PCH-FW settings.

Console Redirection

When the Console Redirection Function is enabled, the console information will be output to both the display monitor and through the serial port.

Options: Disabled (default), Enabled

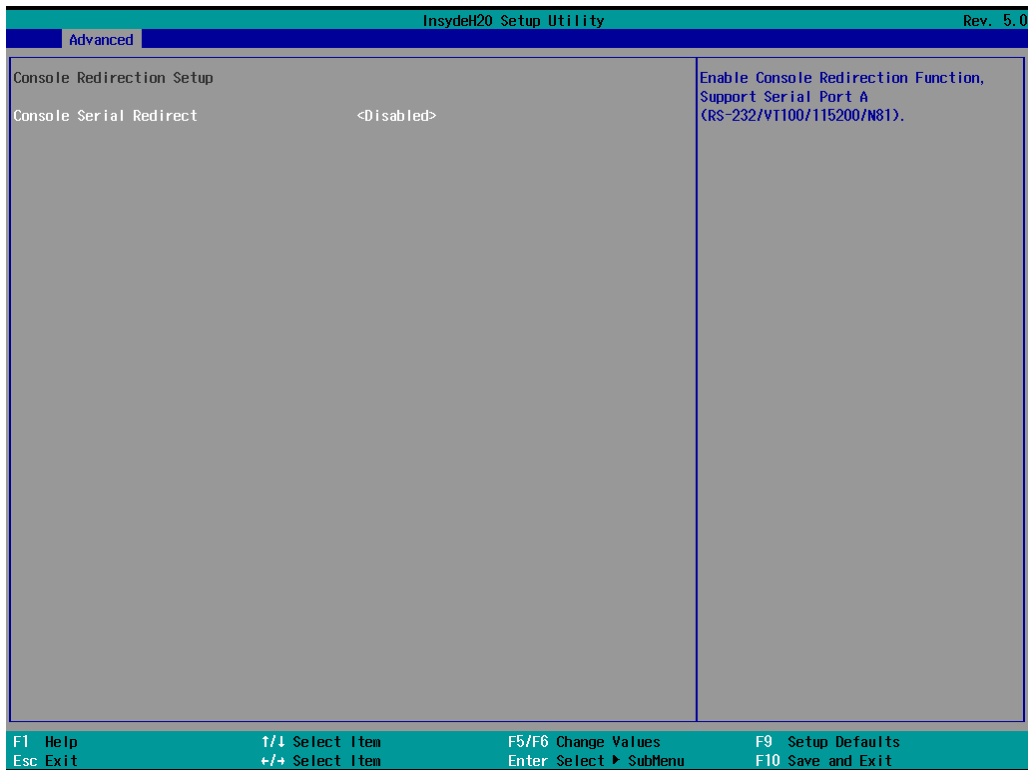

SIO ITE8786E

This section allows users to configure SIO settings.

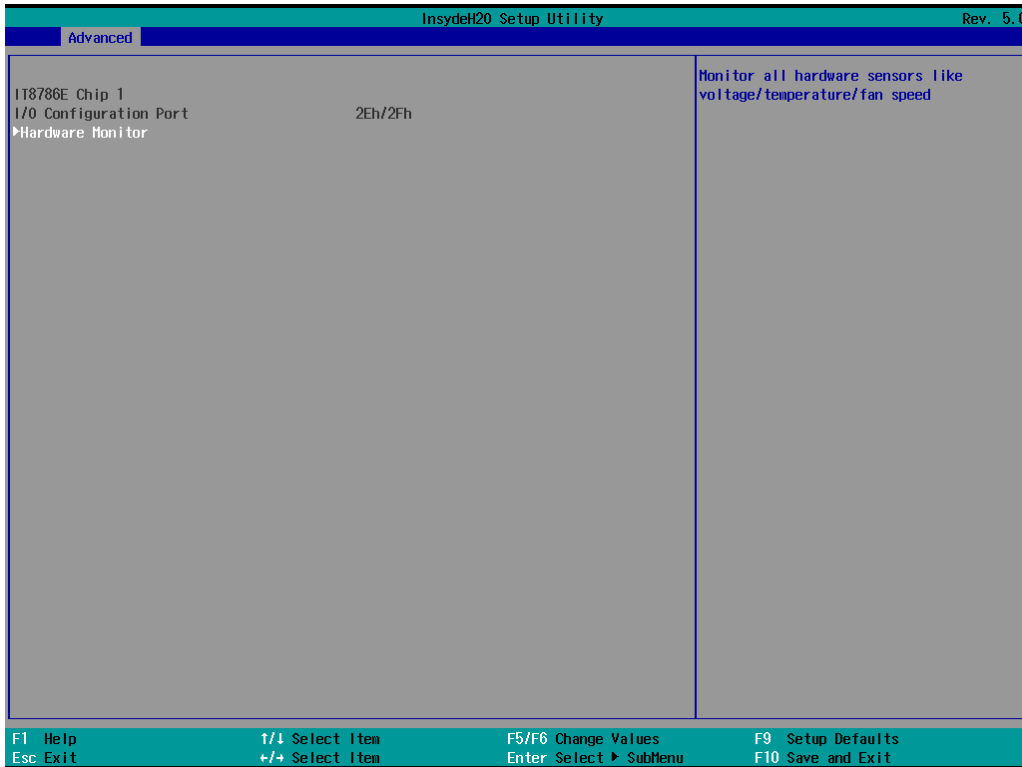

Hardware Monitor

This item allows you to view stats such as CPU and system temperature, voltage levels, and other chipset information.

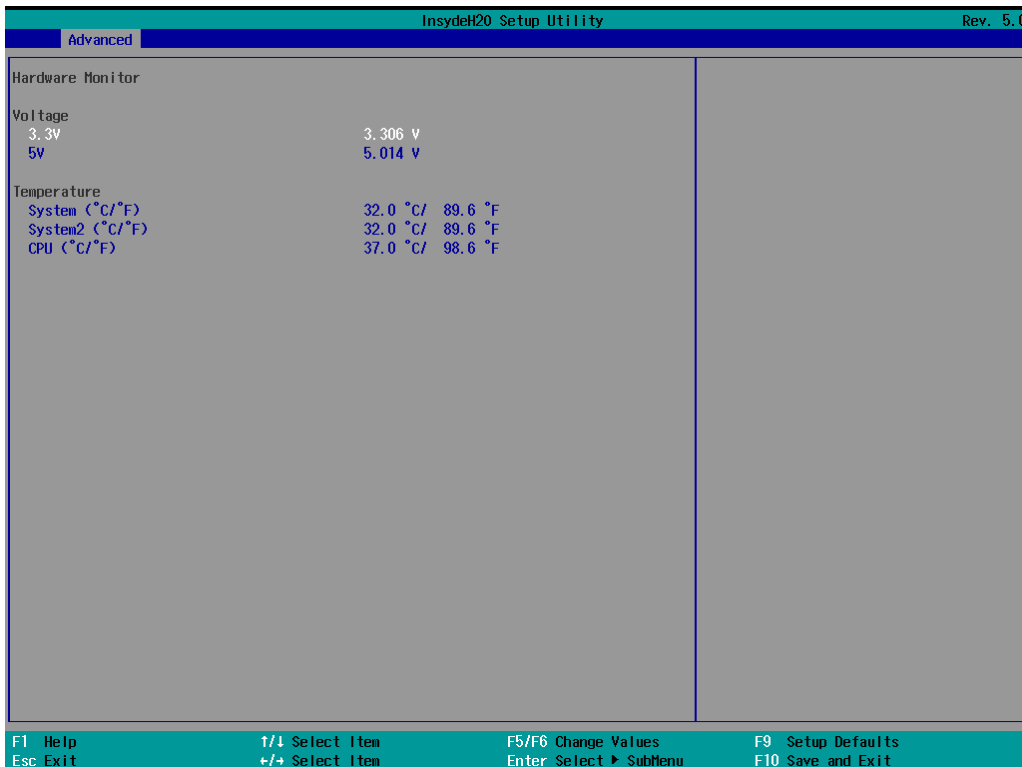

Security Settings

This section allows users to configure security-related settings with a supervisor password and user password.

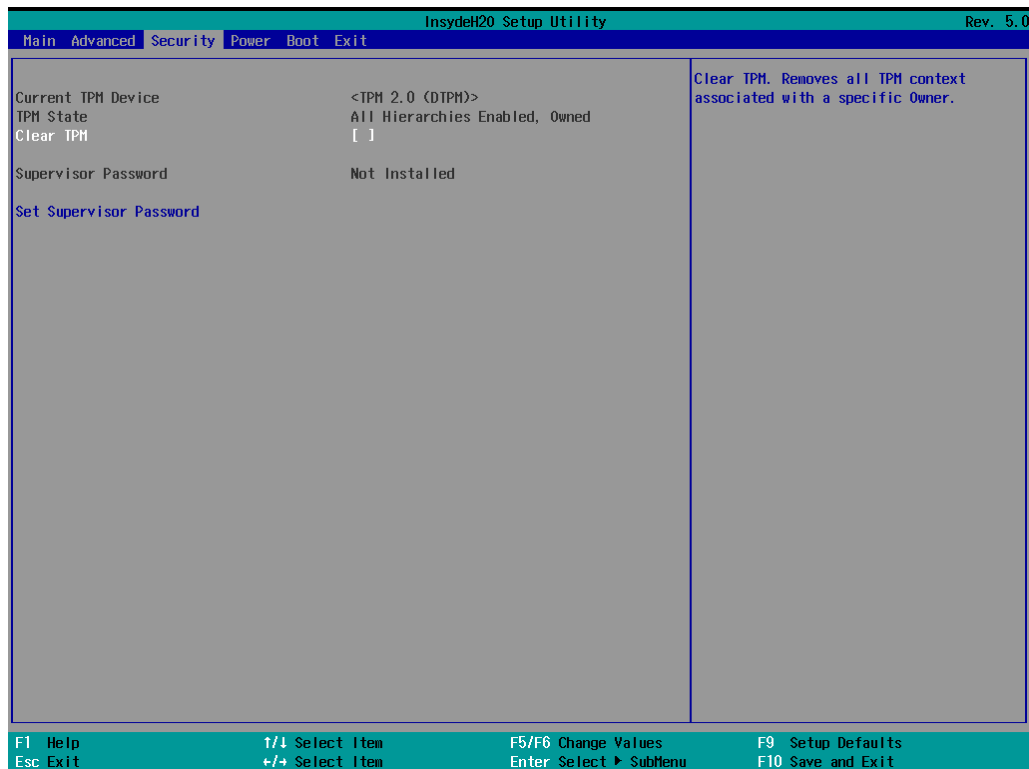

Current TPM Device

This item shows if the system has TPM device and its type.

TPM State

This item allows you view the status of current TPM settings.

Clear TPM

This item allows users to remove all TPM context associated with a specific owner.

Set Supervisor Password

This item allows you to set the supervisor password. Select the **Set Supervisor Password** option and enter the password and confirm the password again.

To delete the password, select the **Set Supervisor Password** option and enter the old password; leave the new password fields blank, and then press enter.

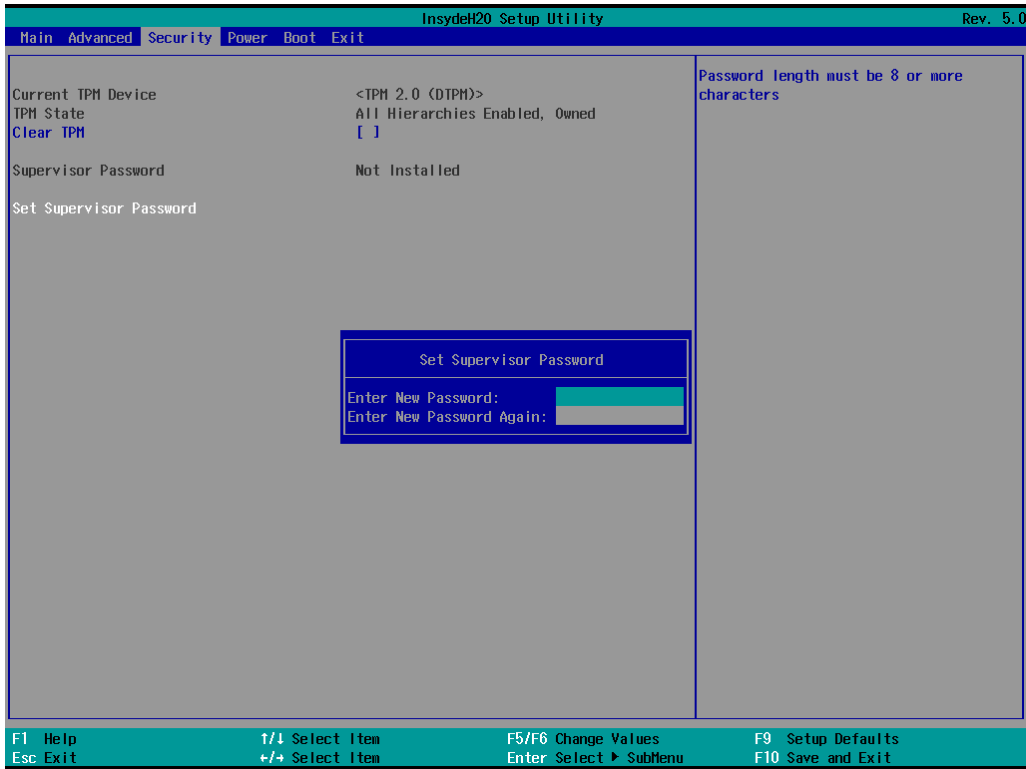

After setting the supervisor password, users can choose when the input password screen should be displayed.

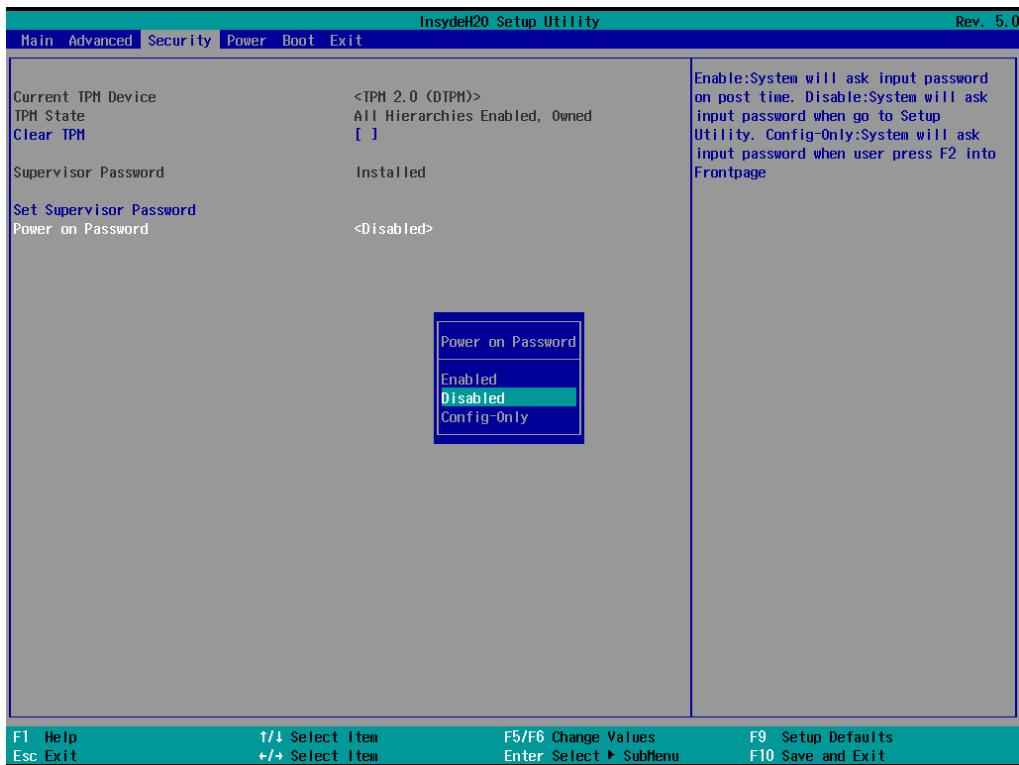

Enable: System will ask for the password on post time

Disable: System will ask for the password to go to the setup utility

Config-Only: System will only ask for the password when you select the config (F2) option

Power Settings

The section allows users to configure power settings.

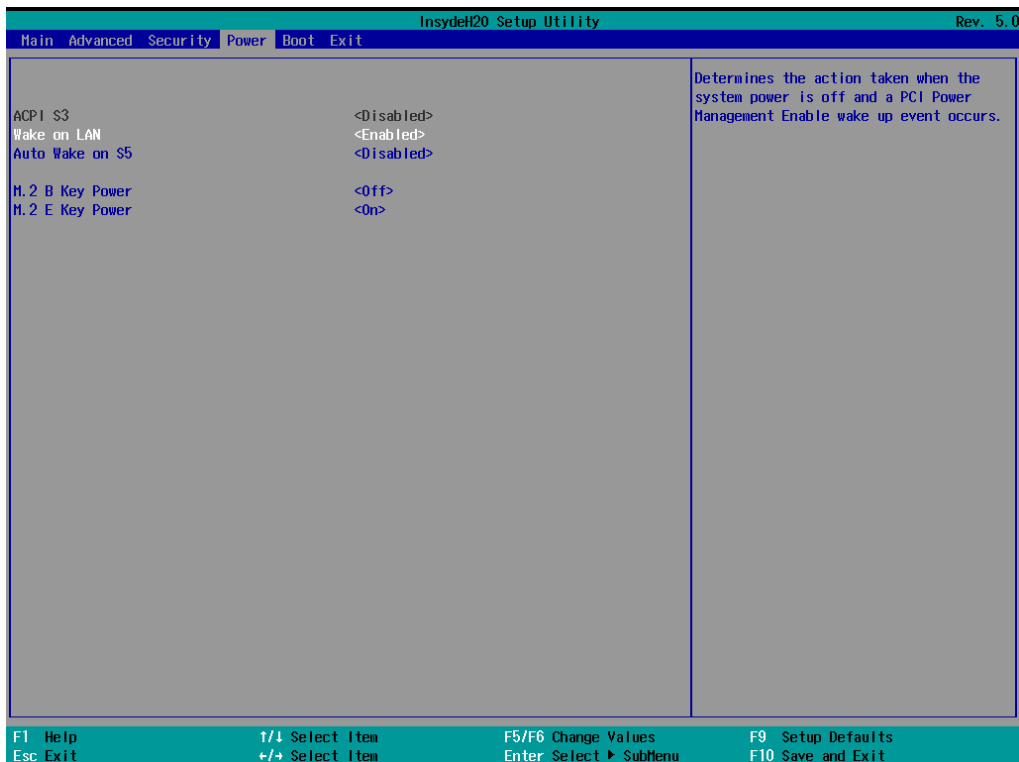

Wake on LAN

This feature is used to wake the system by a LAN device from a remote host.

Options: Enabled (default), Disabled

Auto Wake on S5

This item allows you to configure the computer to wake from S5 status. S5 stands for Soft Off, where the PSU remains engaged but power to all other parts of the system is cut. Auto-wake on S5 schedules a soft-reboot at certain periodic times that may be specified in the BIOS.

Options: Disabled (default); By Every Day (user specifies a regular daily time when the computer will power up); By Day of Month (user specifies a regular day each month when the computer will power up)

M.2 B Key Power

This item allows you to control the default power of the M.2 B Key slot for 5G module (USB 3.0 interface).

Options: Off (default), on

M.2 E Key Power

This item allows you to control the default power of the M.2 E Key slot for Wi-Fi module (PCIe x1 interface).

Options: Off, On (default)

Boot Settings

The section allows users to configure boot settings.

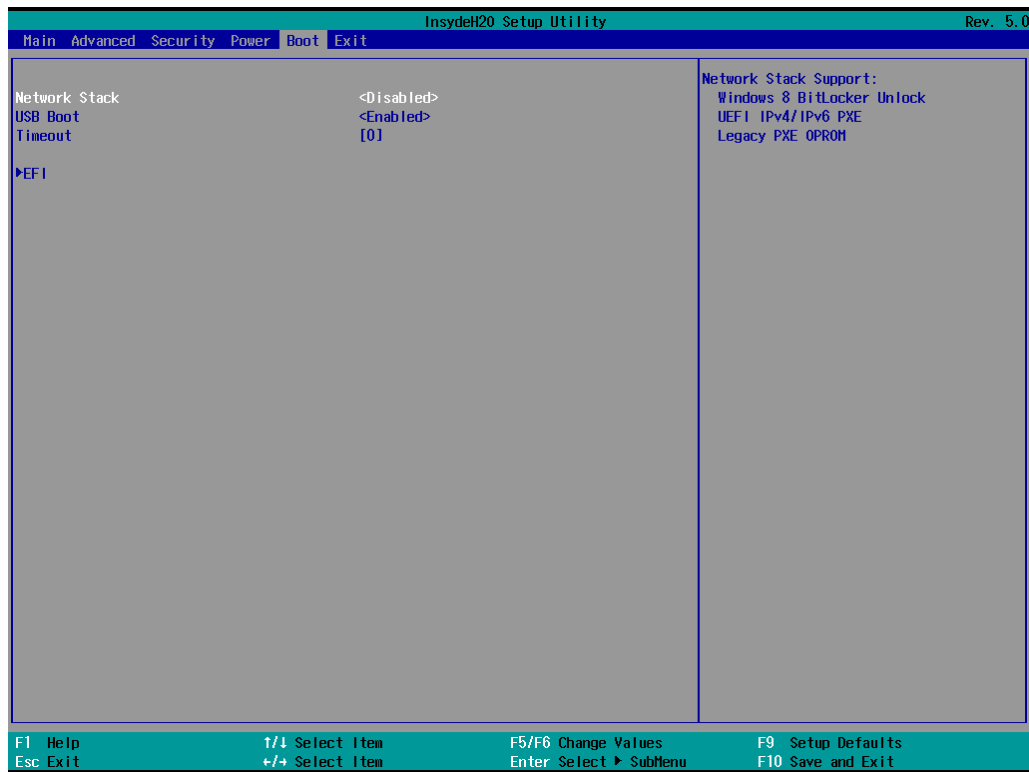

NOTE

If you do not add any storage, you will not see the EFI option.

Network Stack

It deploys an Internet Protocol (IP) stack. The IP stack provides an application library to open/close connections to remote devices and send/receive data between the remote devices.

Options: Disabled (default), Enabled

PXE Boot capability

This item will be shown only when you have enabled the Network Stack.

PXE Booting is booting a system over a network. This item allows users to start PXE over IPv4 or IPv6

Options: Disabled (default), UEFI: IPv4, UEFI: IPv6, UEFI: IPv4/IPv6

USB Boot

Set booting to USB boot devices capability.

Options: Enabled (Default), Disabled

Timeout

This item allows users to set the number of seconds that the firmware will wait before booting using the original default boot selection.

EFI

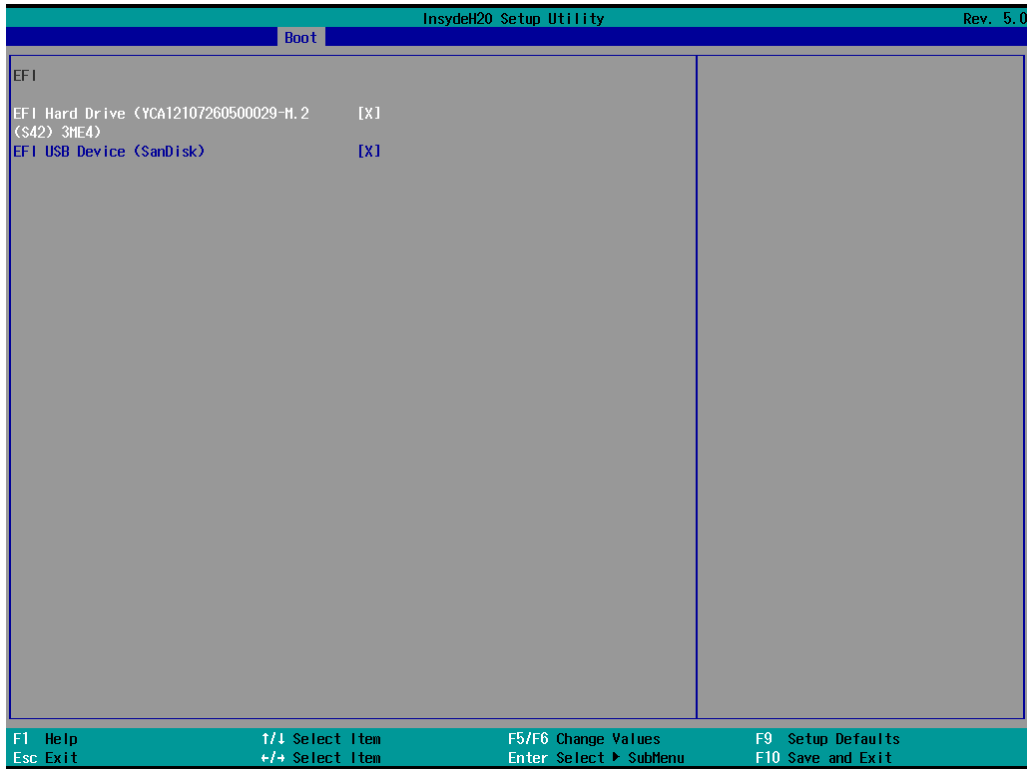

This item allows users to select the boot order. Use F5 (move down) or F6 (move up) to change the value.

Exit Settings

The section allows users to exit the BIOS environment.

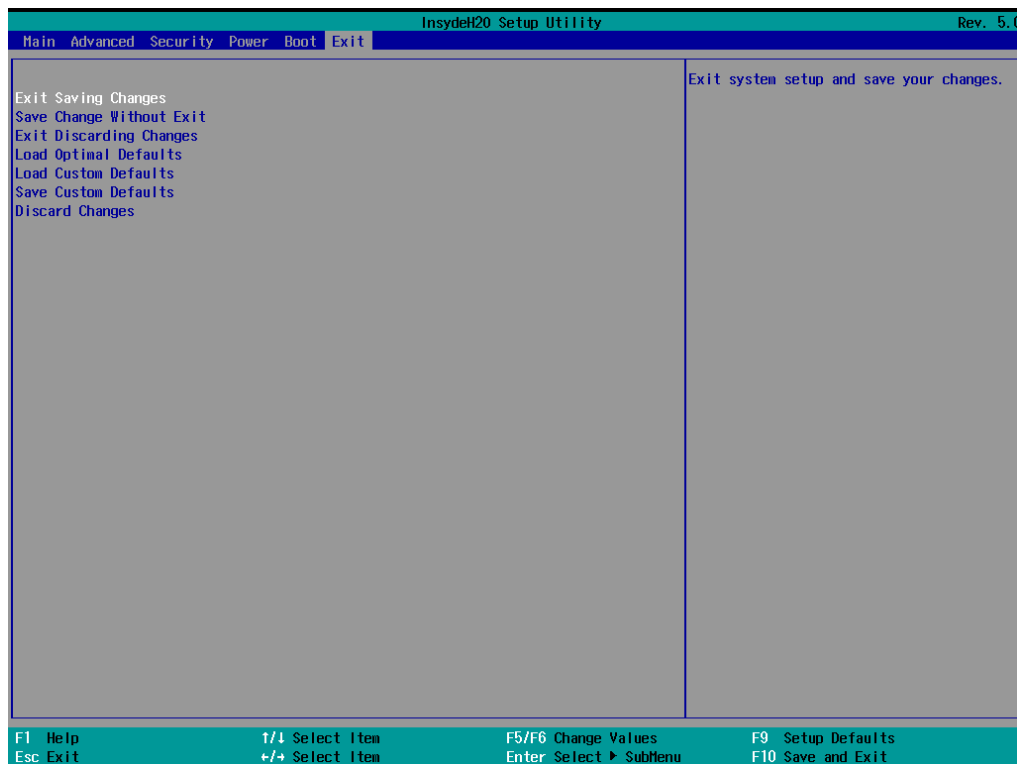

Exit Saving Changes

This item allows you to exit the BIOS environment and save the values you have just configured.

Options: Yes (default), No

Save Change Without Exit

This item allows you to save changes without exiting the BIOS environment.

Options: Yes (default), No

Exit Discarding Changes

This item allows you to exit without saving any changes that might have been made to the BIOS.

Options: Yes (default), No

Load Optimal Defaults

This item allows you to revert to the factory default BIOS values.

Options: Yes (default), No

Load Custom Defaults

This item allows you to load custom default values for the BIOS settings.

Options: Yes (default), No

Save Custom Defaults

This item allows you to save the current BIOS values as a “custom default” that may be reverted to at any time by the load custom defaults selection.

Options: Yes (default), No

Discard Changes

This item allows you to discard all settings you have just configured.

Options: Yes (default), No

AMT



NOTE

The AMT function is not supported in the models with Celeron and i3 CPU.

Enabling AMT

To enter the BIOS setup utility, press the “F2” key while the system is booting up. The main **BIOS Setup** screen will appear. Five options will be available:

1. Select **Intel® Management Engine BIOS Extension** to enter the **AMT configuration**.

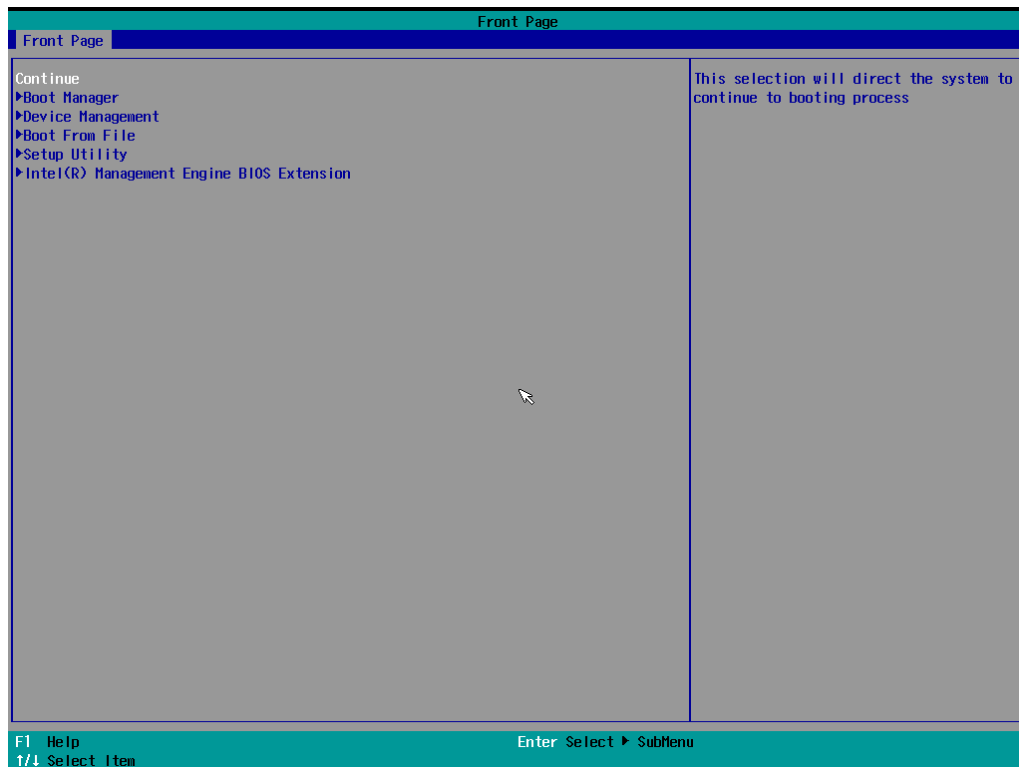

2. Press **<Enter>** to start the login procedure.

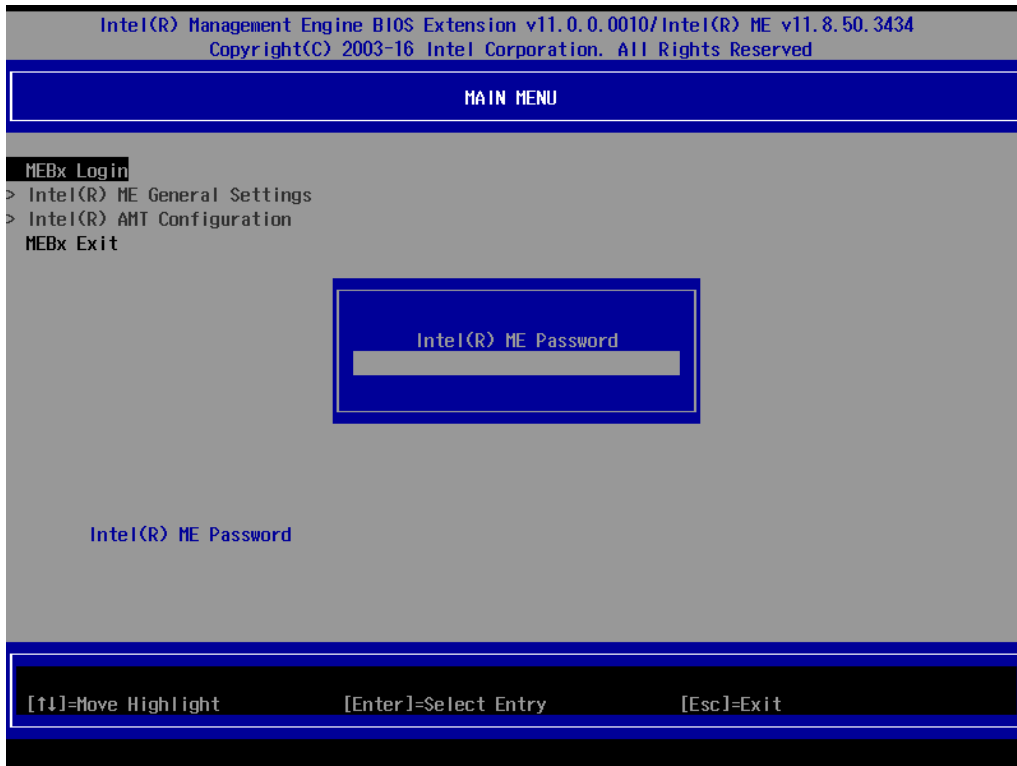

3. Type the default password: **admin**

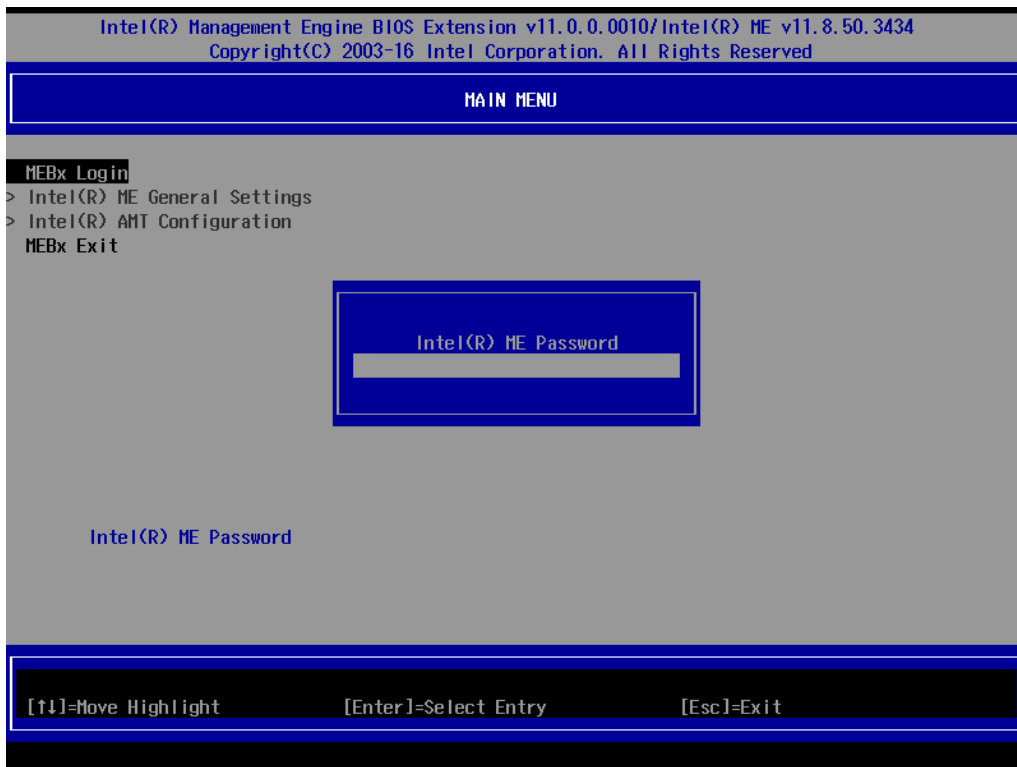

4. Type the new password. It must include both upper-case and lower-case characters, numbers, and special symbols. E.g., **Admin'12**.

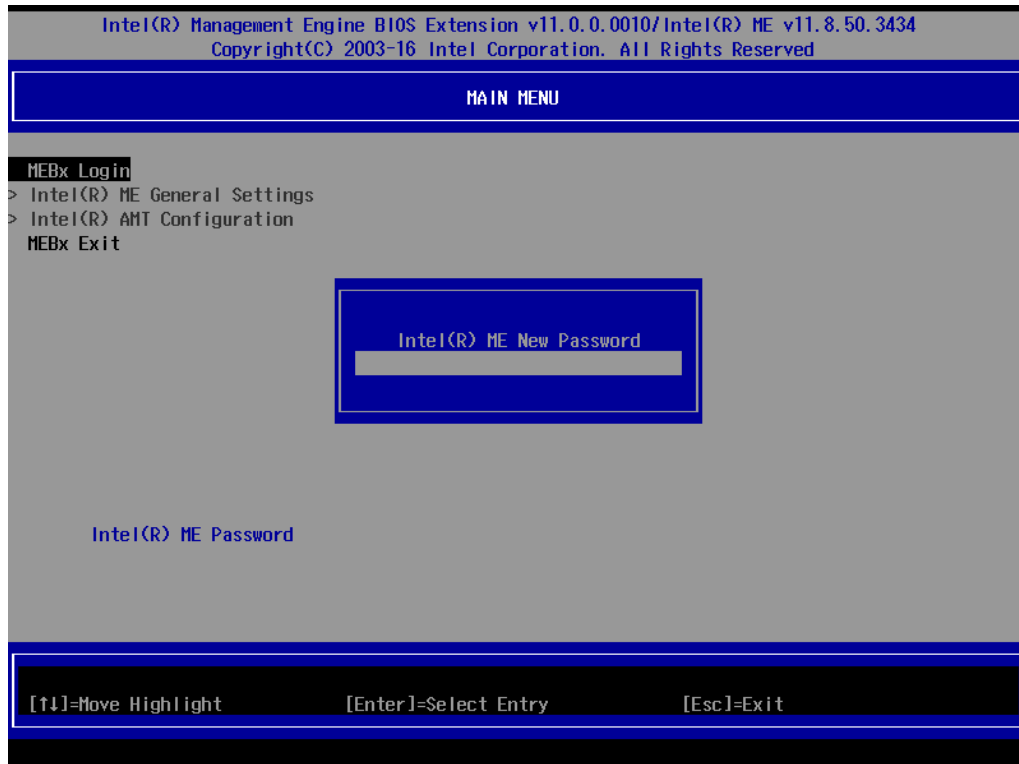

5. Select **Intel® AMT Configuration** to enable remote access without a local user present for consent, select **User Consent**, and then select **User Opt-in** and change the value to **None**.

6. Set static IP or DHCP by request.

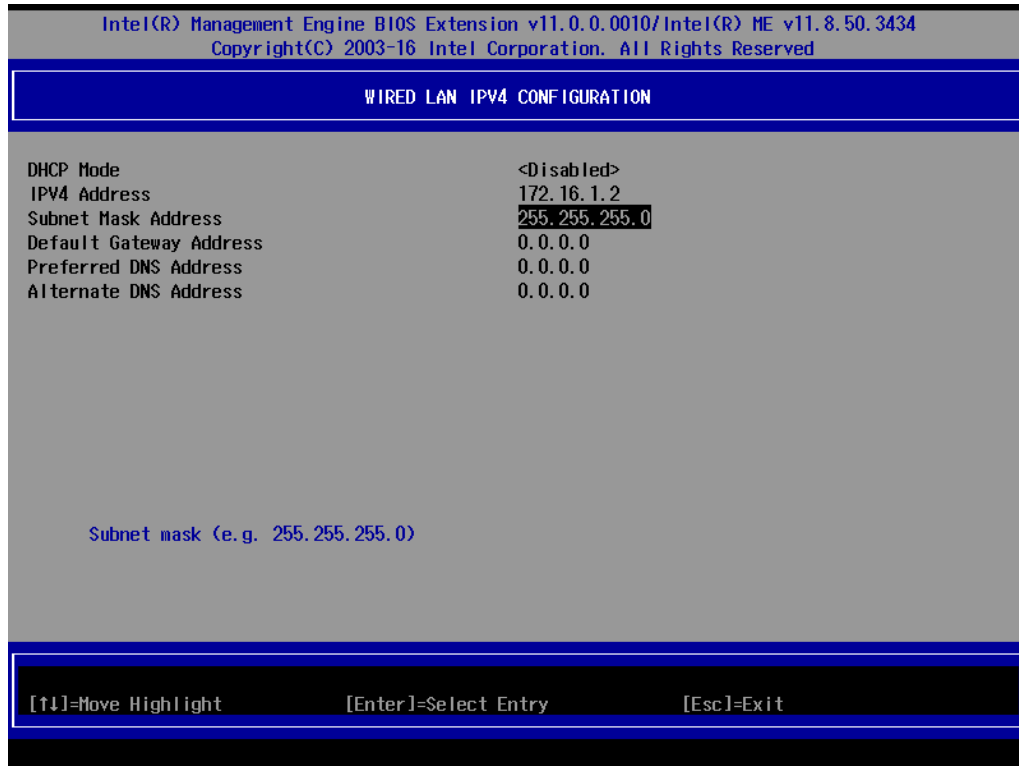

7. Set **Activate Network Access** to enable remote access capability.

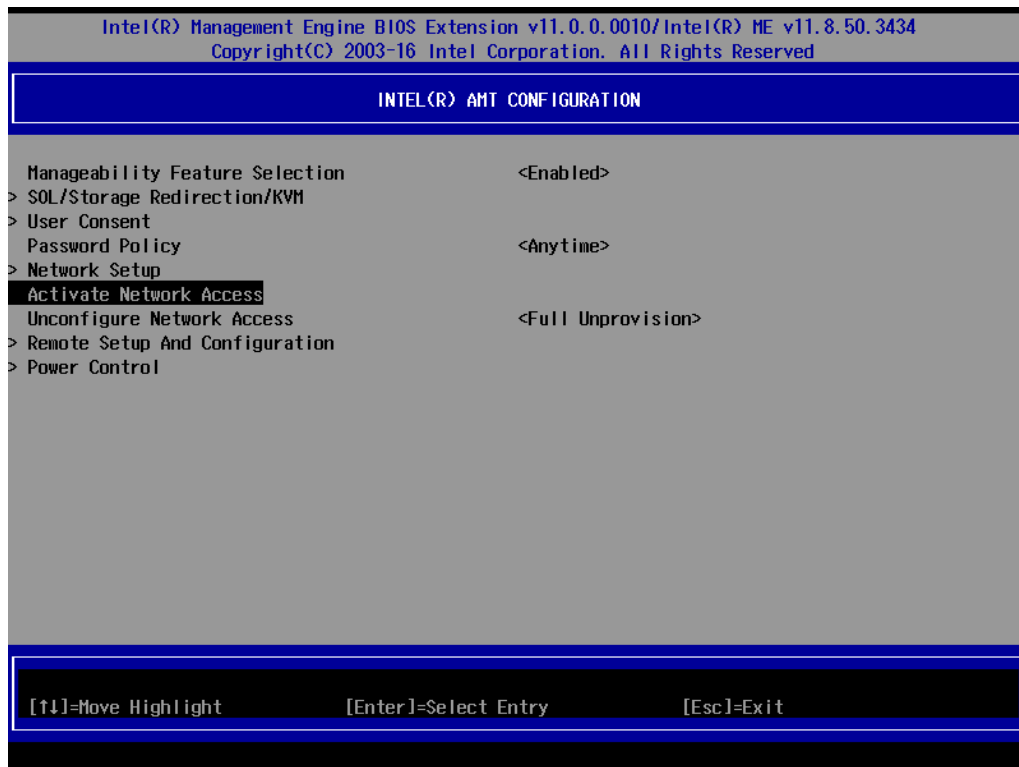

Using AMT

You can use any AMT tool available to run the remote management function using a web browser.

Type the IP address of your computer as configured in the AMT configuration settings with port **16992**.

1. The AMT logon screen will appear.



2. Click **Log On** and type the username (**admin**) and password.

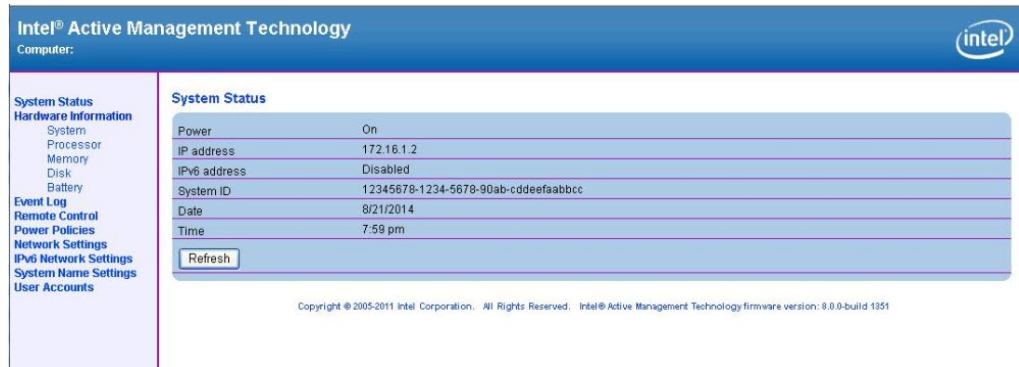

NOTE

The AMT port is LAN1.



NOTE

For details, refer to the Intel AMT Implementation and Reference Guide at:

https://software.intel.com/sites/manageability/AMT_Implementation_and_Reference_Guide/default.htm?url=WordDocuments%2Faccessingintelamtviathewebuiinterface.htm

Administering Secure Boot

Press F2 to go to the Administer Secure Boot.

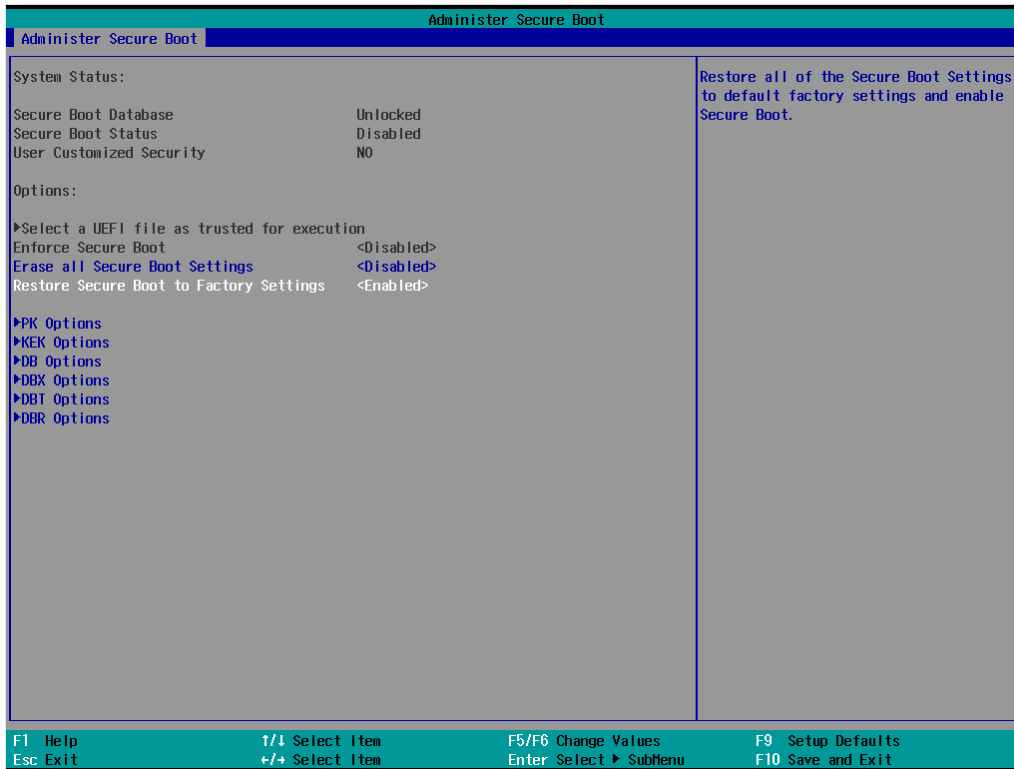

Secure Boot helps computers resist attacks and infection from malware. The feature defines an interface between the operating system and BIOS. It detects tampering with boot loaders, key operation system files, and unauthorized option ROMs by validating their digital signatures.

Enabling UEFI Secure Boot

Set as "enabled" in "Restore Secure Boot to Factory Settings" under Administer Secure Boot menu. Press F10 as save and exist.



The Microsoft key is included in the BIOS by default. If you cannot boot up using a non-Windows OS, use the following example.

Enroll EFI Image

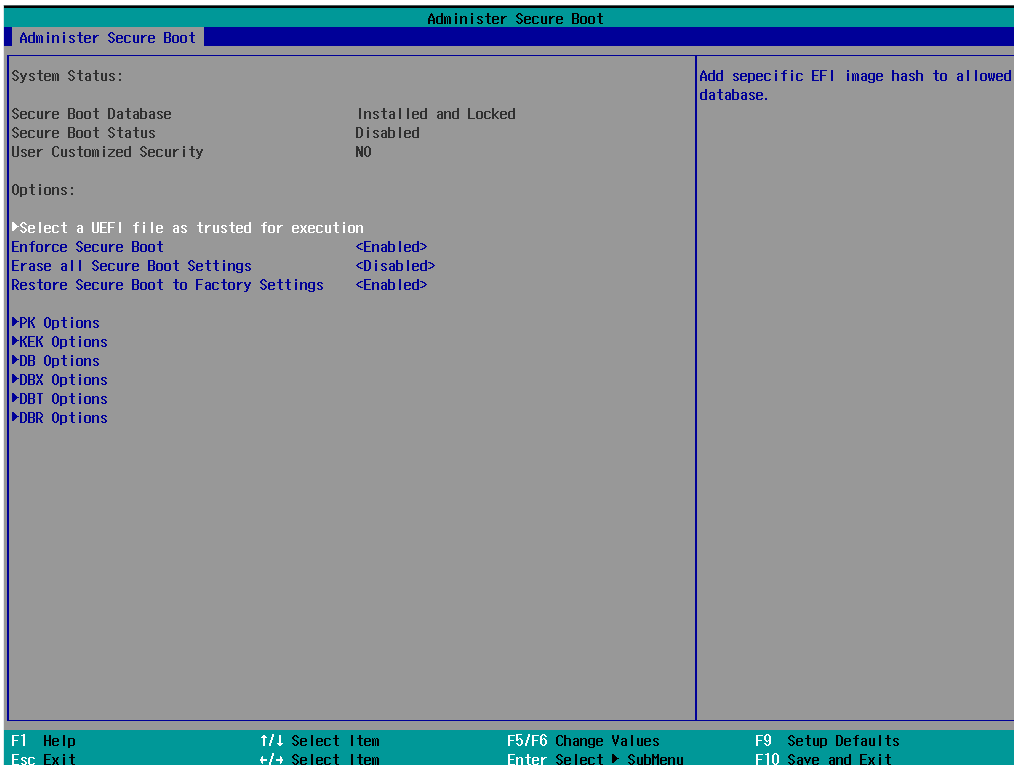

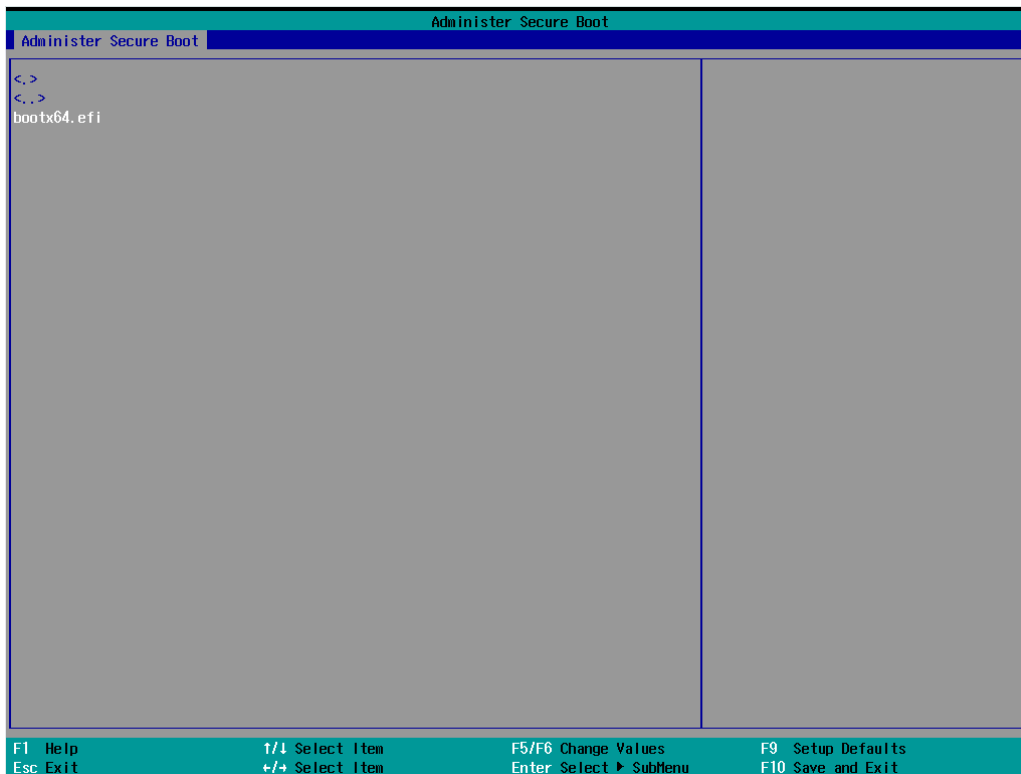

Enter "Administer Secure Boot" once again and see "Select a UEFI file as trusted for execution", put loader into the database named and followed by the UEFI standard \EFI\BOOT\BOOT{machine type short-name}. E.g., efi\boot\BootX64.efi, Debian (EFI\debian\grubx64.efi), Suse (EFI\opensuse\grubx64.efi)

Enroll Customer Key

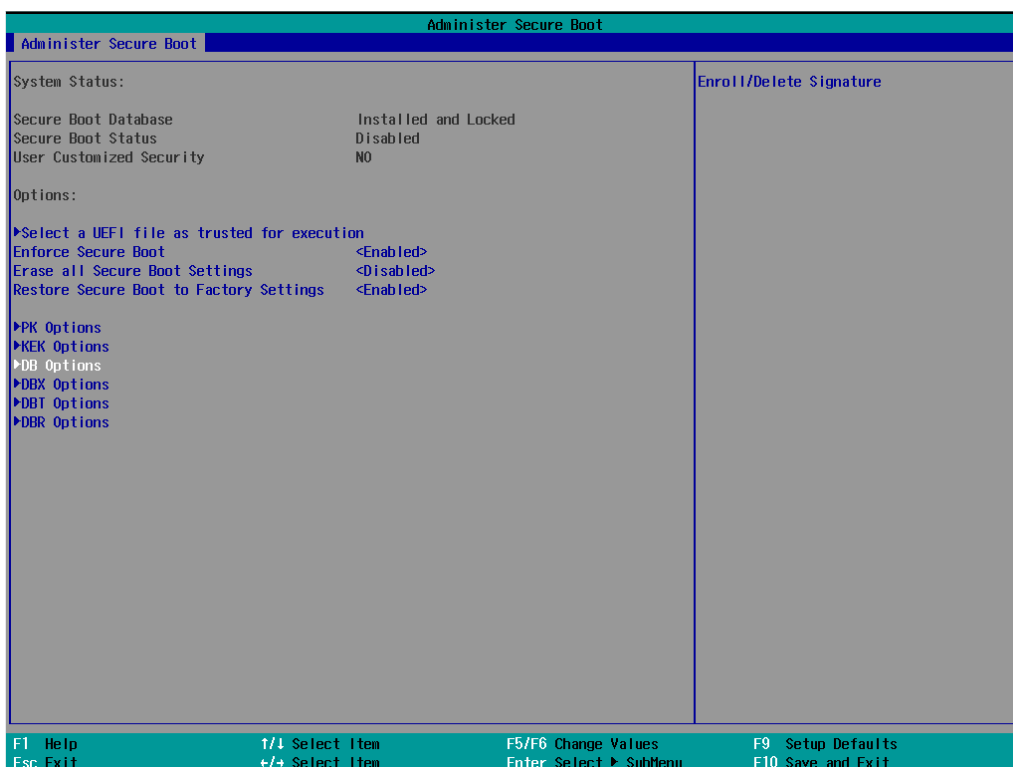

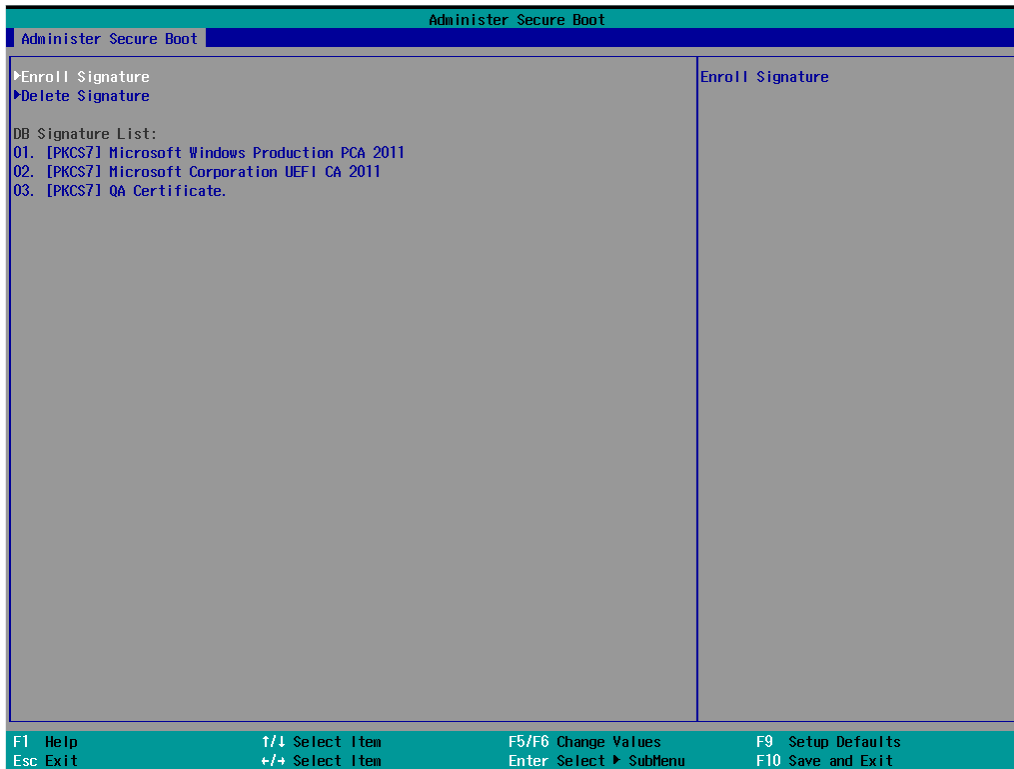

Enter "DB OPTION" and enroll your key. Please make sure your key is CRT format and uses RSA 2048 or better.

Upgrading the BIOS

This section describes how to upgrade the BIOS on your computer.



NOTE

It is possible to permanently damage the computer when upgrading the BIOS. We strongly recommend that you contact Moxa's technical support staff for assistance to obtain all the necessary tools and the most current advice before attempting to upgrade the BIOS on any Moxa device.

Step 1: Create a Bootable USB Disk

Before upgrading the BIOS, you must create a bootable USB drive as a system boot device for use in the future.

1. Insert a USB disk in the computer's USB drive.
2. Search for "format" and select **Create and format hard disk partitions**.

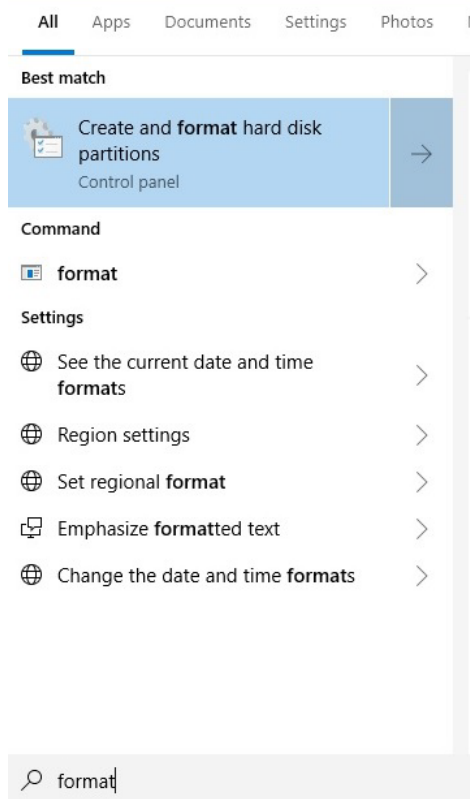

3. Right-click on the USB disk item and select **Format**.

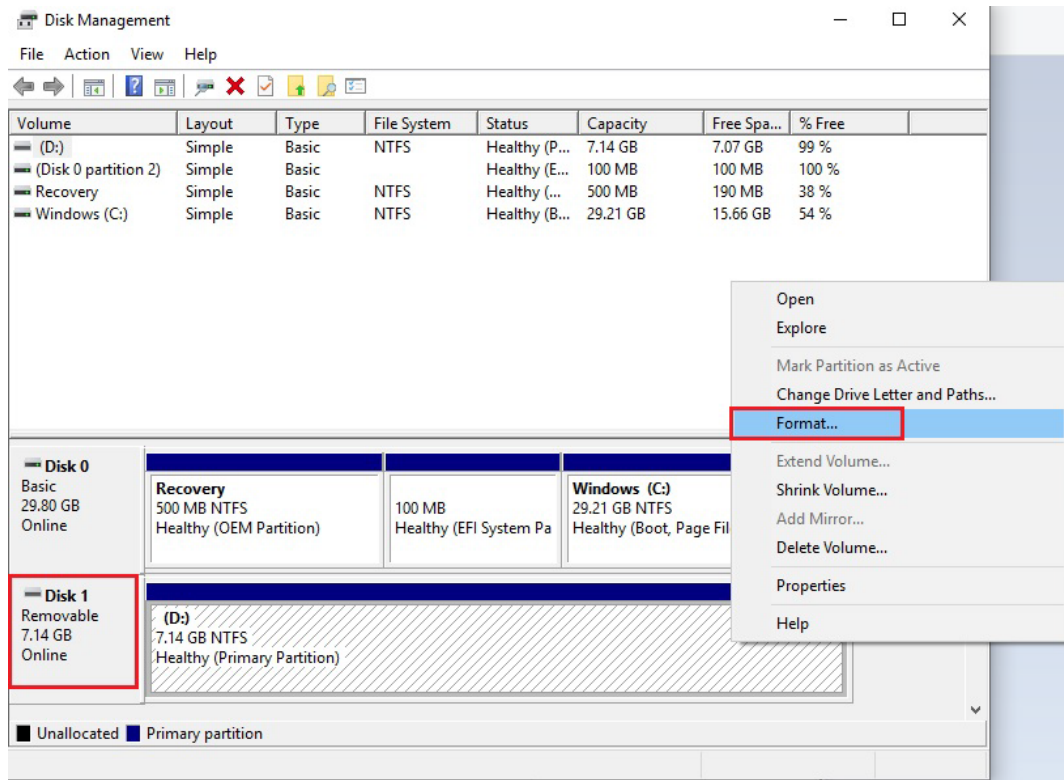

4. Select **FAT32** and click **OK** to start formatting the disk.

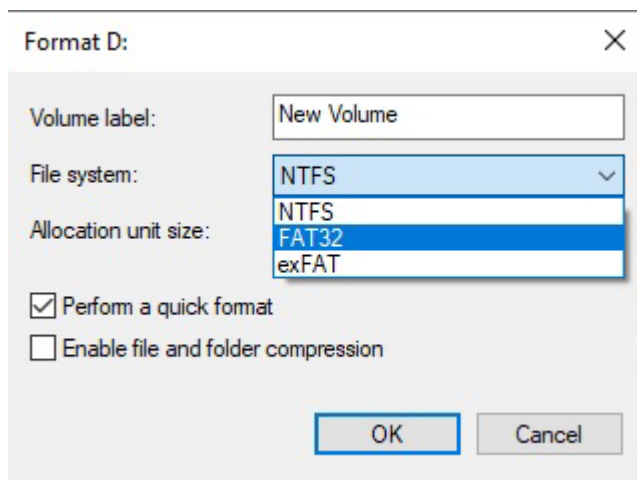

Step 2: Prepare the Upgrade File

You must use the BIOS upgrade installation file to upgrade the BIOS. Contact Moxa's technical department for assistance. The BIOS upgrade file includes an **efi** folder and an **xxxx.efi** file. Copy the **efi** folder and **xxxx.efi** file to the bootable USB disk.

Step 3: Run the Upgrade Program on Your Computer

1. Reboot the computer with the boot disk and press F2 to go to the Boot Manager.
If the BIOS cannot recognize the USB drive as the boot-up device, the USB drive might not have a partition table. Use the Windows command line tool **diskpart** to rebuild the partition table.
2. Select the USB Disk.



The screen will switch to the SHELL environment.

3. Type **fs0:**, go to the directory where the upgrade file is located, and type **xxxxxx.efi** (the file name is based on the upgrade file from Moxa).

```
Device mapping table
fs0      :Removable HardDisk - Alias hd24s0b blk0
          PciRoot(0x0)/Pci(0x14, 0x0)/USB(0x12, 0x0)/HD(1, MBR, 0x00DD3D80, 0x3F, 0xEB5FC1)
blk0     :Removable HardDisk - Alias hd24s0b fs0
          PciRoot(0x0)/Pci(0x14, 0x0)/USB(0x12, 0x0)/HD(1, MBR, 0x00DD3D80, 0x3F, 0xEB5FC1)
blk1     :Removable BlockDevice - Alias (null)
          PciRoot(0x0)/Pci(0x14, 0x0)/USB(0x12, 0x0)
hd24s0b  :Removable HardDisk - Alias fs0 blk0
          PciRoot(0x0)/Pci(0x14, 0x0)/USB(0x12, 0x0)/HD(1, MBR, 0x00DD3D80, 0x3F, 0xEB5FC1)

Shell> fs0:
fs0:\> xxxxxx.efi
```

4. Wait until the upgrade procedure is completed.



NOTE

Do NOT switch off the power supply during the BIOS upgrade, since doing so may cause the system to crash.

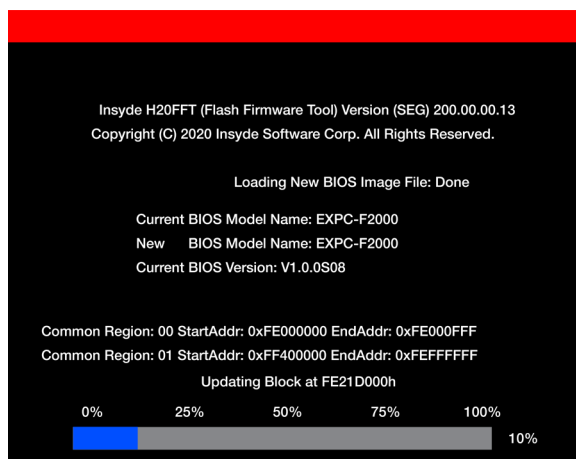

When the upgrade is finished, the computer will automatically reboot.

You can check the BIOS version on the Main page to confirm the upgrade.

Main	Advanced	Security	Power	Boot	Exit
Project Name	EXPC-F2000				
BIOS Version	v1.0.0s08				

If the system has more than one boot device, you will see more than one fsx (x represents the number).

```
EFI Shell version 2.50 [22281.41491]
Current running mode 1.1.2
Device mapping table
fs0 :HardDisk - Alias hd33e0a2 blk0
      PciRoot(0x0)/Pci(0x17,0x0)/Sata(0x4,0x0,0x0)/HD(2,GPT,0AC3B829-99B0-4FDE-844D-8A10C1D55C6C,0xFA000,0x32000)
fs1 :Removable HardDisk - Alias hd25r0b blk1
      PciRoot(0x0)/Pci(0x14,0x0)/USB(0x11,0x0)/HD(1,MBR,0x00DD3D80,0x3F,0xEB5FC1)
fs2 :Removable BlockDevice - Alias f25s0 blk2
      PciRoot(0x0)/Pci(0x14,0x0)/USB(0x12,0x0)
blk0 :HardDisk - Alias hd33e0a2 fs0
      PciRoot(0x0)/Pci(0x17,0x0)/Sata(0x4,0x0,0x0)/HD(2,GPT,0AC3B829-99B0-4FDE-844D-8A10C1D55C6C,0xFA000,0x32000)
blk1 :Removable HardDisk - Alias hd25r0b fs1
      PciRoot(0x0)/Pci(0x14,0x0)/USB(0x11,0x0)/HD(1,MBR,0x00DD3D80,0x3F,0xEB5FC1)
blk2 :Removable BlockDevice - Alias f25s0 fs2
      PciRoot(0x0)/Pci(0x14,0x0)/USB(0x12,0x0)
blk3 :HardDisk - Alias (null)
      PciRoot(0x0)/Pci(0x17,0x0)/Sata(0x4,0x0,0x0)/HD(1,GPT,5796BAEF-EC3F-447F-B4F1-21EB08DC5D57,0x800,0xF9800)
blk4 :HardDisk - Alias (null)
      PciRoot(0x0)/Pci(0x17,0x0)/Sata(0x4,0x0,0x0)/HD(3,GPT,7C8FF3C6-53E8-4CF9-8141-65DF7EF04399,0x12C000,0x8000)
blk5 :HardDisk - Alias (null)
      PciRoot(0x0)/Pci(0x17,0x0)/Sata(0x4,0x0,0x0)/HD(4,GPT,1AABAECE-BE17-4C27-AF60-E6C69977AC02,0x134000,0x3A6E800)
blk6 :BlockDevice - Alias (null)
      PciRoot(0x0)/Pci(0x17,0x0)/Sata(0x4,0x0,0x0)
blk7 :Removable BlockDevice - Alias (null)
      PciRoot(0x0)/Pci(0x14,0x0)/USB(0x11,0x0)
```

5. Go to each fsx (x stands for the number) and type ls to view the content of the boot device.

If you find an upgrade file, run it.

```
fs0:\> fs1:
fs1:\> ls
Directory of: fs1:\
06/27/19 11:43a <DIR>          16,384 efi
06/13/19 11:10a              17,974,704 820C100S16 efi
1 File(s) 17,974,704 bytes
1 Dir(s)
```

5. Configuring the Serial Interface

Overview

The EXPC-F2000W supports the following serial modes: **RS-232**, **RS-422**, **2-wire RS-485**, and **4-wire RS-485**. These modes can be configured on COM3, COM4, and COM5 (COM1, COM2, and COM3 on the device label).

Installing the SerialInterface Utility

Complete the following steps to install the **SerialInterface** utility:

1. The SerialInterface setup *.exe file can be found on the product DVD: <Software DVD>\utility\SerialInterface\x64 to. Execute "**SerialInterfaceSetup-4.6.0.exe**" and when the application program launches, click **Next** to continue, and then click **Next** again.

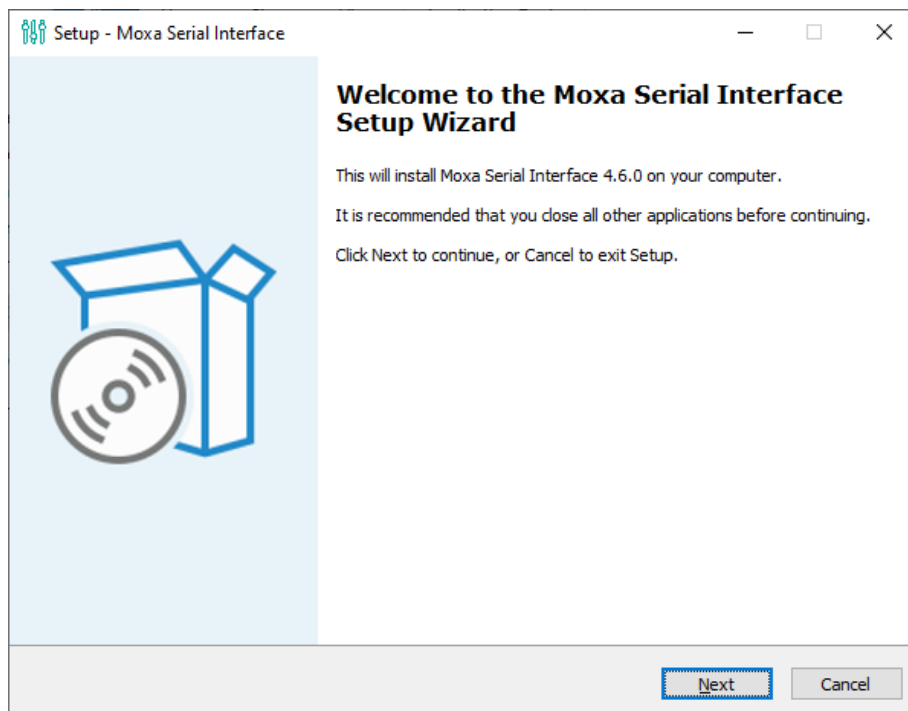

2. Click **Next** to continue.

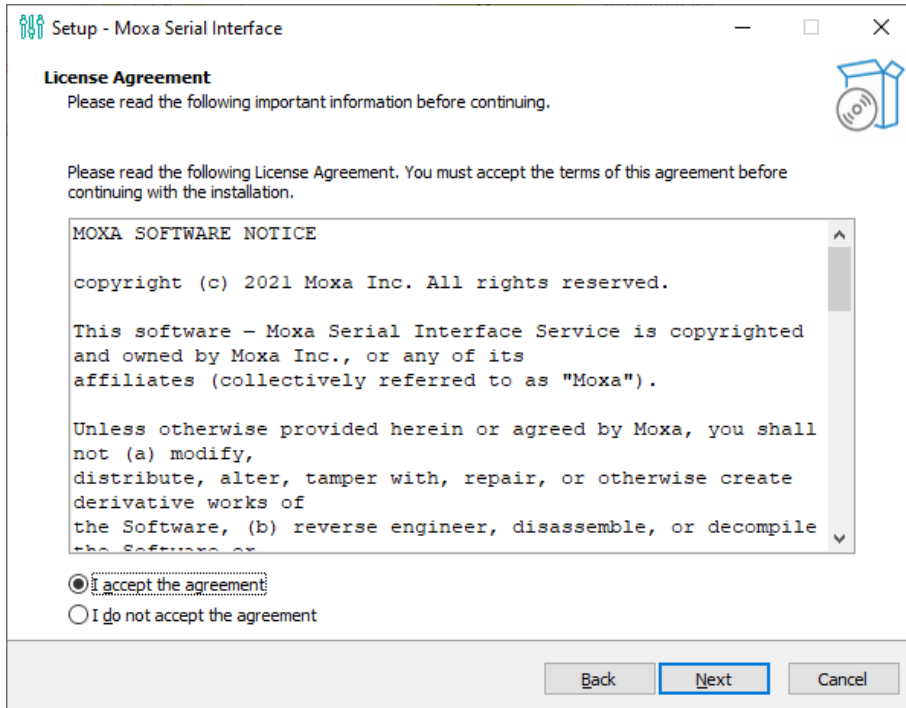

3. The default destination folder is **C:\Program Files\Moxa\Moxa Serial Interface**; click **Install** to continue.

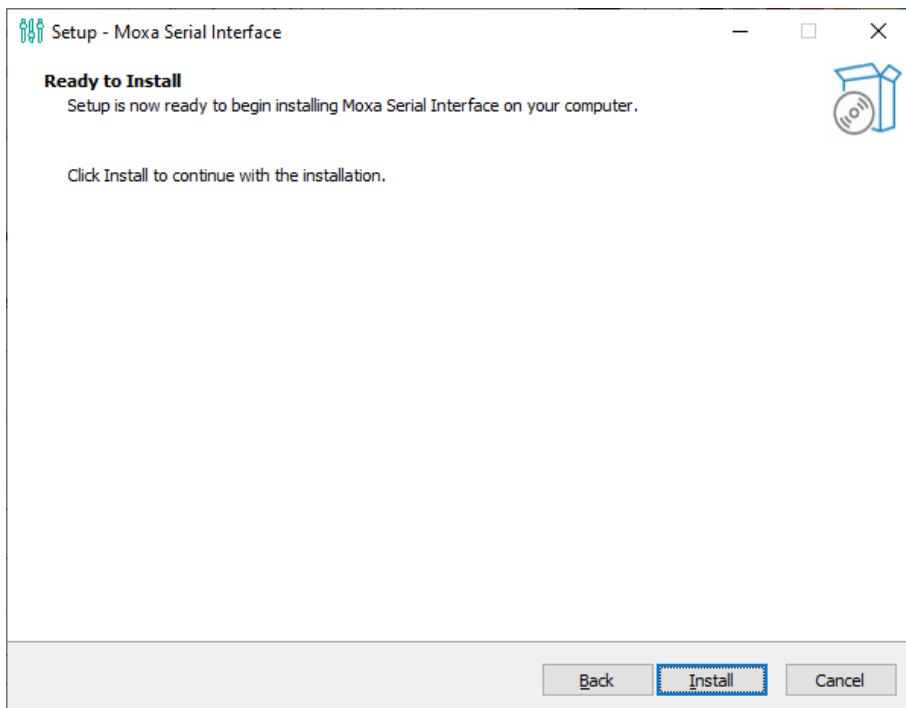

4. Click **Finish** to complete installation.

Configuring the Serial Interface Mode

Complete the following steps to configure the interface mode:

1. From the Start menu, Click **All Programs** → **Moxa Serial Interface** -> **Moxa Serial Interface**.

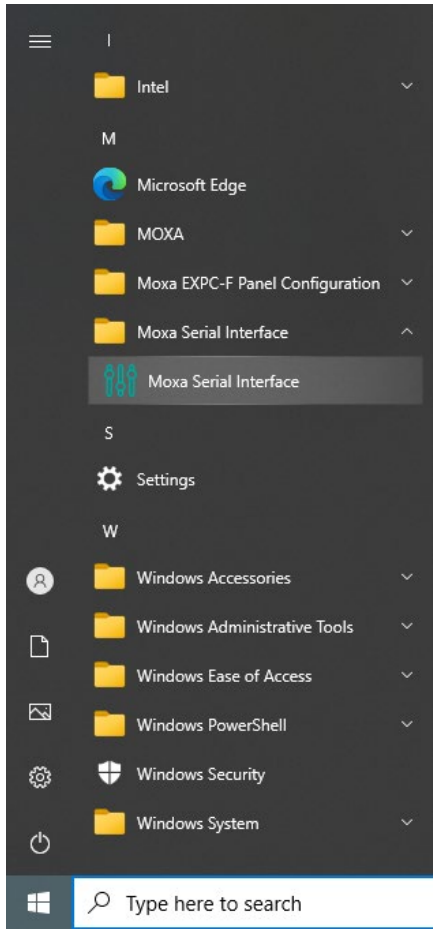

2. Select a COM port (COM3, COM4, COM5).

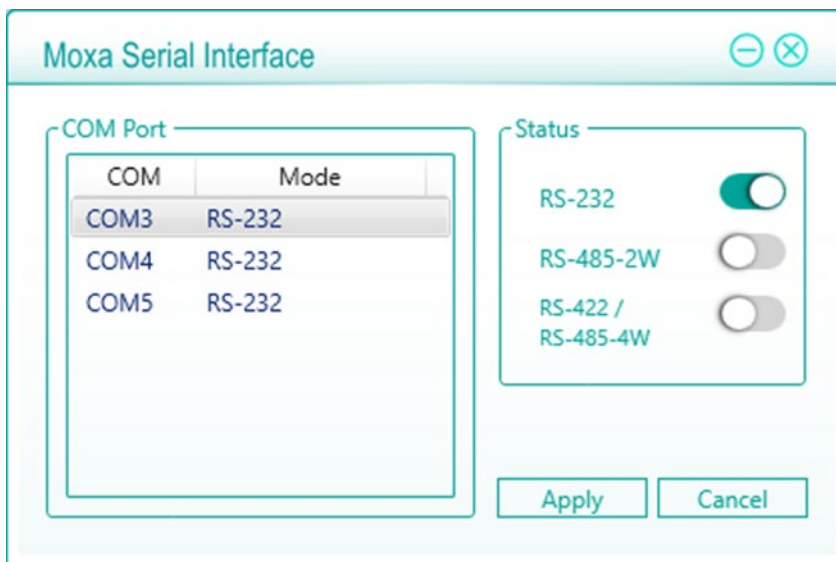

3. Select the mode for the port selected in the previous step.

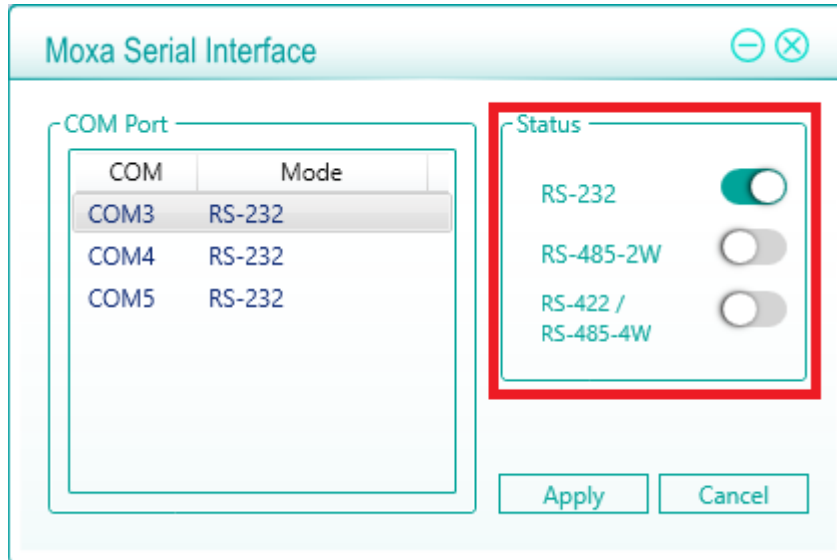

4. Click **Apply**.

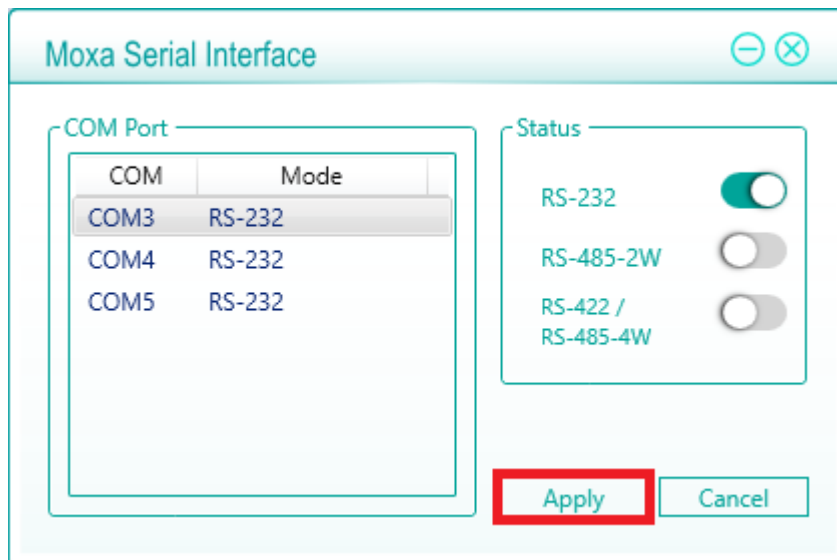

A. Regulatory Approval Statement



This device complies with part 15 of the FCC Rules. Operation is subject to the following two conditions: (1) This device may not cause harmful interference, and (2) this device must accept any interference received, including interference that may cause undesired operation.

Class A: FCC Warning! This equipment has been tested and found to comply with the limits for a Class A digital device, pursuant to part 15 of the FCC Rules. These limits are designed to provide reasonable protection against harmful interference when the equipment is operated in a commercial environment. This equipment generates, uses, and can radiate radio frequency energy and, if not installed and used in accordance with the instruction manual, may cause harmful interference to radio communications. Operation of this equipment in a residential area is likely to cause harmful interference in which case the user will be required to correct the interference at his/her own expense.



European Community

Warning:

This is a **Class A** product. In a domestic environment this product may cause radio interference, in which case the user may be required to take compensatory measures.