

# MPC-2120 Series Quick Installation Guide

---

**Edition 2.0, October 2018**

## **Technical Support Contact Information** **[www.moxa.com/support](http://www.moxa.com/support)**

### Moxa Americas:

Toll-free: 1-888-669-2872

Tel: 1-714-528-6777

Fax: 1-714-528-6778

### Moxa China (Shanghai office):

Toll-free: 800-820-5036

Tel: +86-21-5258-9955

Fax: +86-21-5258-5505

### Moxa Europe:

Tel: +49-89-3 70 03 99-0

Fax: +49-89-3 70 03 99-99

### Moxa Asia-Pacific:

Tel: +886-2-8919-1230

Fax: +886-2-8919-1231

### Moxa India:

Tel: +91-80-4172-9088

Fax: +91-80-4132-1045



© 2018 Moxa Inc. All rights reserved.

**P/N: 1802021200011**



## Overview

The MPC-2120 12-inch panel computers with Intel® Atom™ E3800 Series processors deliver a reliable and durable platform of wide versatility for use in industrial environments. With two software selectable RS-232/422/485 serial ports and two gigabit Ethernet LAN ports, the MPC-2120 panel computers support a wide variety of serial interfaces as well as high-speed IT communications, all with native network redundancy.

## Package Checklist

Before installing the MPC-2120, verify that the package contains the following items:

- 1 MPC-2120 panel computer
- 1 2-pin terminal block for DC power input
- 1 10-pin terminal block for DIO
- 1 2-pin terminal block for remote power switch
- 8 panel mounting screws
- Quick installation guide (printed)
- Warranty card

*NOTE: Please notify your sales representative if any of the above items are missing or damaged.*

## Hardware Installation

### Front View

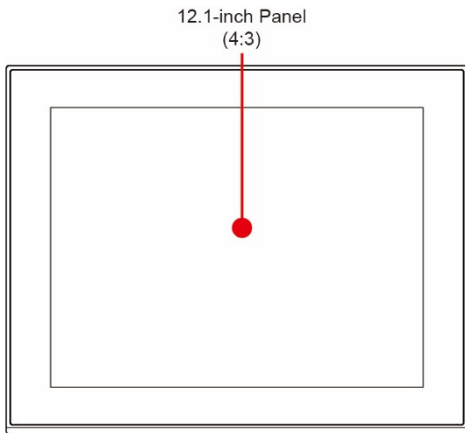

### Bottom View

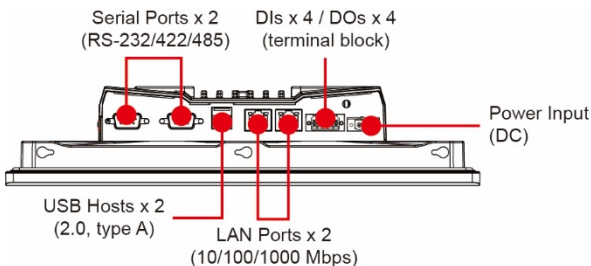

## Panel Mounting

A panel-mounting kit consisting of 8 mounting units is provided in the MPC-2120 package. For details on the dimensions and the cabinet space required to panel mount the MPC-2120, refer to the following illustration:

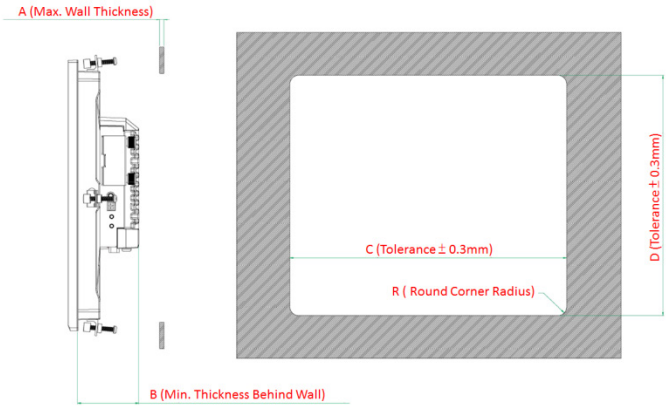

A	B	C	D	R	MountingKits (pcs)
11mm	56mm	287.4mm	226.3mm	2mm	8pcs

To install the panel-mounting kit on the MPC-2120, place the mounting units in the holes provided on the rear panel and push the units to the left as shown in the illustration below:

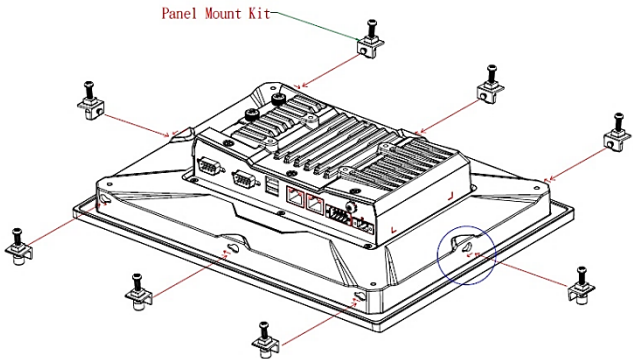

Use a torque of 4Kgf-cm to secure the mounting screws to fasten the panel-mounting kit onto the wall.

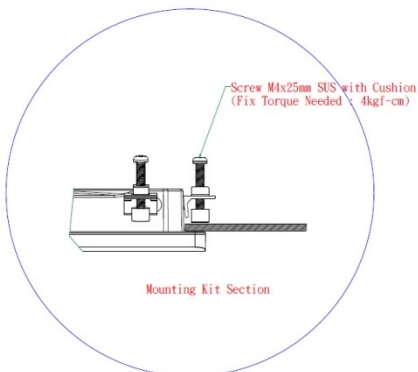

### **VESA Mounting**

The MPC-2120 is provided with VESA-mounting holes on the back panel, which you can use directly without the need for an adapter. The dimension of the VESA mounting area is 50 mm x 75 mm. You will require four 6-mm M4 screws to VESA mount the MPC-2120.

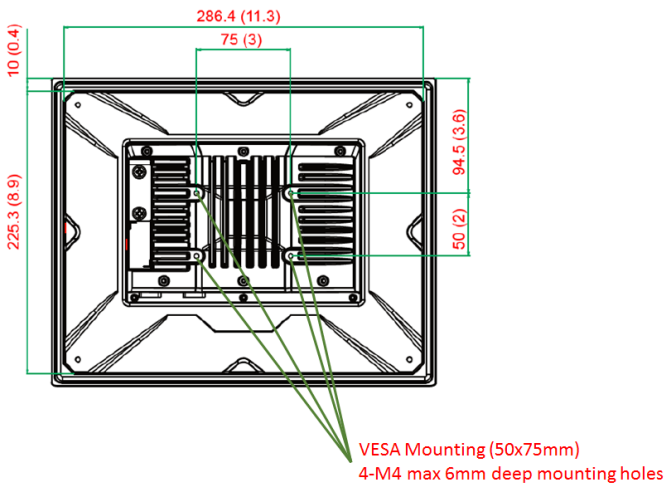

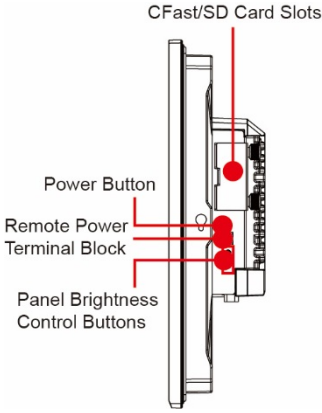

## Display-Control Buttons

The MPC-2120 is provided with two display-control buttons on the right panel.



The display-control buttons can be used as described in the following table:

Symbol and Name	Usage	Function
 Power	Press	<ul style="list-style-type: none"><li>• Power on</li><li>• Enter Sleep or Hibernation mode</li><li>• Wake up</li></ul> <p>NOTE: You can change the function of the power button in the OS settings menu</p>
	Press and hold for 4 seconds	Power off
 Brightness +	Press	Manually increase the brightness of the panel
 Brightness -	Press	Manually decrease the brightness of the panel



### ATTENTION

The MPC-2120 comes with a 1000-nit display, the brightness level of which is adjustable up to level 10. The display is optimized for use in the -40 to 70°C temperature range. However, if you are operating the MPC-2120 at an ambient temperature of 60°C or higher, we recommend setting the brightness level of the display to 8 or lower in order to extend the lifetime of the display.

## Connector Description

### DC Power Input

The MPC-2120 uses a DC power input. To connect the power source to the 2-pin terminal block, use a 60 W power adapter. The terminal-block connector for the power input is available in the accessories package. The DC pin assignments are as shown in the figure.

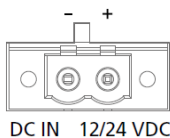

### Serial Ports

The MPC-2120 offers two software-selectable RS-232/422/485 serial ports over a DB9 connector. The pin assignments for the ports are shown in the table below:

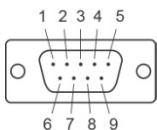

Pin	RS-232	RS-422	RS-485 (4-wire)	RS-485 (2-wire)
1	DCD	TxDA(-)	TxDA(-)	-
2	RxD	TxDB(+)	TxDB(+)	-
3	TxD	RxDB(+)	RxDB(+)	DataB(+)
4	DTR	RxDA(-)	RxDA(-)	DataA(-)
5	GND	GND	GND	GND
6	DSR	-	-	-
7	RTS	-	-	-
8	CTS	-	-	-

### Ethernet Ports

The pin assignments for the two Fast Ethernet 100/1000 Mbps RJ45 ports are shown in the following table:

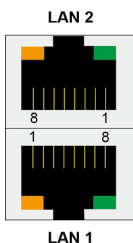

Pin	100 Mbps	1000 Mbps
1	ETx+	TRD(0)+
2	ETx-	TRD(0)-
3	ERx+	TRD(1)+
4	-	TRD(2)+
5	-	TRD(2)-
6	ERx-	TRD(1)-
7	-	TRD(3)+
8	-	TRD(3)-

The LEDs on the LAN ports indicate the following:

LAN 1/LAN 2 (indicators on the connectors)	Green	100 Mbps Ethernet mode
	Yellow	1000 Mbps (Gigabit) Ethernet mode
	Off	No activity / 10 Mbps Ethernet mode

### USB Ports

Two USB 2.0 ports are available on the bottom panel. Use these ports to connect mass-storage drives and other peripherals.

## **DIO Port**

The MPC-2120 is provided with a DIO port, which is a 10-pin terminal block that includes 4 DIs and 4 DOs as illustrated in the following diagram.

DI 1 2 3 4 GND

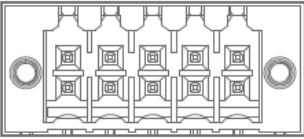

DO 1 2 3 4 COM

### **DI Dry Contact**

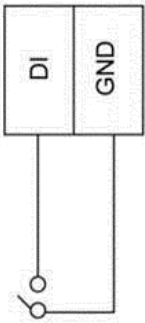

### **DI Wet Contact**

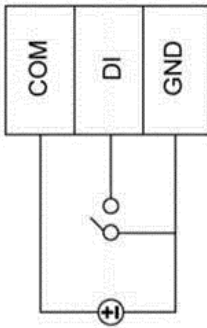

### **DO Contact Sink**

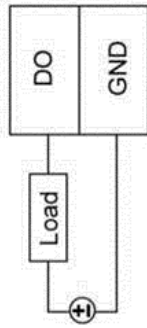

## **Installing a CFast or SD Card**

MPC-2120 provides two storage options—CFast and SD card. The storage slots are located on the left panel. You can install the OS on the CFast card and save your data into the SD card. For a list of compatible CFast models, check the MPC-2120 component compatibility report available on Moxa's website.

To install the storage devices, do the following:

1. Remove the 2 screws holding the storage-slot cover to the MPC-2120.

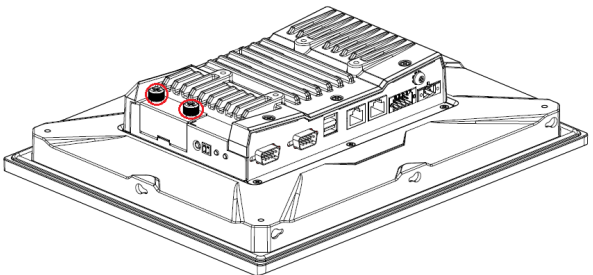

2. Insert the CFast or SD card into the slot using the push-push mechanism.

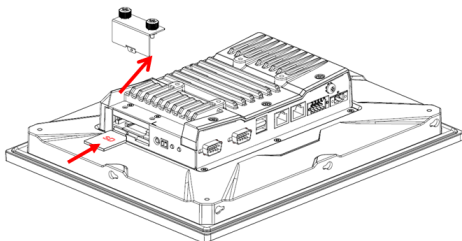
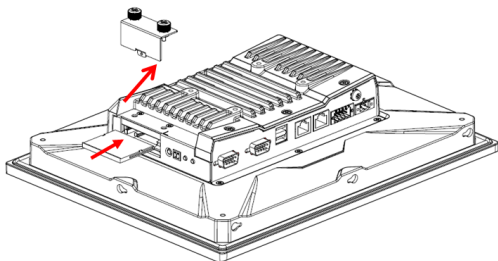

3. Reattach the cover and secure it with screws.

### **Real-Time Clock**

The real-time clock (RTC) is powered by a lithium battery. We strongly recommend that you do not replace the lithium battery without help from a qualified Moxa support engineer. If you need to change the battery, contact the Moxa RMA service team. The contact details are available at: [http://www.moxa.com/rma/about\\_rma.aspx](http://www.moxa.com/rma/about_rma.aspx).



### **ATTENTION**

There is a risk of explosion if the clock's lithium battery is replaced with an incompatible battery.

## **Powering On/Off the MPC-2120**

Connect a **Terminal Block to Power Jack Converter** to the MPC-2120 terminal block and connect a 60 W power adapter to the converter. Supply power through the power adapter. After you have connected a power source, the system power turns on automatically. It takes about 10 to 30 seconds for the system to boot up. You can change the power-on behavior of your computer by changing the BIOS settings.

To power off the MPC-2120, we recommend using the "shut down" function provided by the OS installed on the MPC. If you use the **Power** button, you may enter one of the following states depending on the power management settings in the OS: standby, hibernation, or system shutdown mode. If you encounter problems, you can press and hold the **Power** button for 4 seconds to force a hard shutdown of the system.





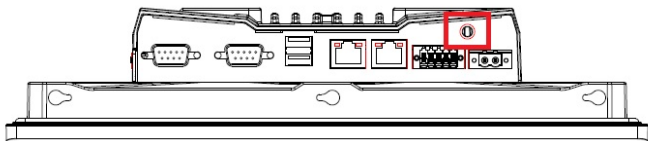

## Grounding the MPC-2120

Proper grounding and wire routing help to limit the effects of noise from electromagnetic interference (EMI). Run the ground connection from the ground screw to the grounding surface prior to connecting the power source.



## Label Drawing Information

Trade Mark:	
Model:	<p>Nomenclature for models MPC-2070 and MPC-2120 series:</p> <p>MPC-2070 -xx -yyyyyyyyyy  I II III</p> <p>I – Screen size:  MPC-2070: 7" panel  MPC-2120: 12" panel</p> <p>II – CPU type  E2: Intel® Atom™ Processor E3826 1.46 GHz  E4: Intel® Atom™ Processor E3845 1.91 GHz (MPC-2120 series only)</p> <p>III – Marketing purpose  0 to 9, A to Z, dash, blank, (,), or any character for marketing purpose.</p>
Rating:	<p>For model MPC-2070-E2-yyyyyyyyyy 12-24 VDC, 2.5 A or 24 VDC, 1.25 A or 12 VDC, 2.5 A</p> <p>For model MPC-2120-xx-yyyyyyyyyy 12-24 VDC, 3.5 A or 24 VDC, 1.75 A or 12 VDC, 3.5 A</p>
S/N	
ATEX information:	  II 3 G DEMKO 18 ATEX 2048X Ex nA IIC T4 Gc Ambient Range : -40°C ≤ Ta ≤ +70°C, or -40°C ≤ Tamb ≤ +70°C Rated Cable Temp ≥ 107 °C

IECEX Certificate no.:	IECEX UL 18.0064X
Address of manufacturer:	FI.4, No.135, Lane 235, Baoqiao Rd. Xindian Dist., New Taipei City, Taiwan

### **Condition of Use**

- Subject devices are intended for use in an area of not more than pollution degree 2 in accordance with IEC/EN 60664-1.
- Subject devices are intended for use in low risk of mechanical impact environments.
- The equipment shall be installed (panel mount) to an enclosure that provides a degree of protection not less than IP54 in accordance with IEC/EN 60079-15, and accessible only by use of a tool.

### **Hazardous Location Standard**

- EN 60079-0:2012 + A11:2013
- EN 60079-15: 2010
- IEC 60079-0 6<sup>th</sup> Edition
- IEC 60079-15 4<sup>th</sup> Edition