

AirWorks AWK-3131A User Manual

Version 9.3, March 2023

www.moxa.com/products



© 2023 Moxa Inc. All rights reserved.

AirWorks AWK-3131A User Manual

The software described in this manual is furnished under a license agreement and may be used only in accordance with the terms of that agreement.

Copyright Notice

© 2023 Moxa Inc. All rights reserved.

Trademarks

The MOXA logo is a registered trademark of Moxa Inc.
All other trademarks or registered marks in this manual belong to their respective manufacturers.

Disclaimer

- Information in this document is subject to change without notice and does not represent a commitment on the part of Moxa.
- Moxa provides this document as is, without warranty of any kind, either expressed or implied, including, but not limited to, its particular purpose. Moxa reserves the right to make improvements and/or changes to this manual, or to the products and/or the programs described in this manual, at any time.
- Information provided in this manual is intended to be accurate and reliable. However, Moxa assumes no responsibility for its use, or for any infringements on the rights of third parties that may result from its use.
- This product might include unintentional technical or typographical errors. Changes are periodically made to the information herein to correct such errors, and these changes are incorporated into new editions of the publication.

Technical Support Contact Information

www.moxa.com/support

Table of Contents

1. Introduction	5
Overview	5
Package Checklist	5
Product Features	6
Functional Design	7
LED Indicators	7
Beeper	9
Reset Button	9
Relay (Digital Output)	9
2. Getting Started	10
First-time Installation and Configuration	10
Communication Testing	12
Function Map	13
3. Web Console Configuration	16
Web Browser Configuration	16
Overview	18
Quick Setup	20
General Setup	22
System Information	22
Interface On/Off	23
Network Settings	23
System Time	26
Wireless LAN Setup	27
AeroMag	28
Operation Mode	33
Basic WLAN Setup	34
WLAN Security Settings	39
Advanced WLAN Settings	47
WLAN Certificate Settings (for EAP-TLS in Client/Client-router/Slave mode only)	53
Advanced Setup	54
Using Virtual LAN	54
Configuring Virtual LAN	56
DHCP Server (for AP/Client-router mode only)	56
Packet Filters	58
RSTP Settings (for Master or Slave mode only)	61
Static Route (for Client-router mode only)	62
NAT Settings/Port Forwarding (for Client-router mode only)	63
SNMP Agent	66
Link Fault Pass-through (for Client/Slave mode only)	67
Gratuitous ARP (for Client/Client-router mode only)	68
Logs and Notifications	69
System Logs	69
Syslog	71
E-mail Notifications	72
Relay	73
Trap	73
Status	75
Associated Client List (for AP/Master mode only)	76
DHCP Client List (for AP mode only)	76
System Logs	77
Relay Status	77
DI and Power Status	78
AeroLink Protection Status (for Client/Slave mode only)	78
System Status	79
Network Status	79
Maintenance	81
Console Settings	81
Ping	81

Firmware Upgrade.....	82
Configuration Import and Export.....	82
Load Factory Default.....	83
Account Settings.....	83
Change Password.....	85
Misc. Settings.....	85
Troubleshooting.....	86
Save Configuration.....	89
Restart.....	90
Logout.....	91
4. Software Installation and Configuration.....	92
Overview.....	92
Wireless Search Utility.....	92
Installing Wireless Search Utility.....	92
Configuring Wireless Search Utility.....	95
5. Using Other Consoles.....	101
RS-232 Console Configuration (115200, None, 8, 1, VT100).....	101
Configuration by Telnet and SSH Consoles.....	103
Configuration by Web Browser with HTTPS/SSL.....	104
Disabling Telnet and Browser Access.....	105
A. References.....	106
AeroLink Protection.....	106
Wireless Distribution System (WDS).....	108
Beacon.....	109
DTIM.....	109
Fragment.....	109
RTS Threshold.....	109
STP and RSTP.....	110
The STP/RSTP Concept.....	110
Differences between RSTP and STP.....	110
B. Supporting Information.....	111
Firmware Recovery.....	111
Declaration of Conformity.....	112
Federal Communication Commission Interference Statement.....	112
RED Compliance Statement.....	112

1. Introduction

The AWK-3131A industrial a/b/g/n high speed wireless Access Point products are ideal wireless solutions for hard-to-wire applications that use mobile equipment connected over a TCP/IP network. The AWK-3131A is rated to operate at temperatures ranging from -25 to 60°C for standard models and -40 to 75°C for wide temperature models, and is rugged enough for any harsh industrial environment.

Overview

The AWK-3131A is 802.11n compliant to deliver speed, range, and reliability to support even the most bandwidth-intensive applications. The 802.11n standard incorporates multiple technologies, including Spatial Multiplexing MIMO (Multi-In, Multi-Out), 20 and 40 MHz channels, and dual bands (2.4 GHz and 5 GHz) to provide high speed wireless communication, while still being able to communicate with legacy 802.11a/b/g devices.

The AWK's operating temperature ranges from -25 to 60°C for standard models and -40 to 75°C for wide temperature models, and is rugged enough for all types of harsh industrial environments. Installation of the AWK is easy using DIN-Rail mounting or distribution boxes, and with its wide operating temperature range, IP30-rated housing with LED indicators, and DIN-Rail mounting it is a convenient yet reliable solution for all types of industrial wireless applications.

Package Checklist

Moxa's AWK-3131A is shipped with the following items. If any of these items is missing or damaged, please contact your customer service representative for assistance.

- 1 AWK-3131A wireless AP/client
- 2.4/5 GHz antennas: ANT-WDB-ARM-0202
- DIN-rail kit
- plastic RJ45 protective caps
- Cable holder with one screw
- Quick installation guide (printed)
- Warranty card



NOTE

The above items come with the standard AWK-3131A model, but the package contents may vary for customized versions.

Product Features

- IEEE 802.11a/b/g/n compliant
- Advanced wireless security
 - 64-bit and 128-bit WEP/WPA/WPA2
 - SSID Hiding/IEEE 802.1X/RADIUS
 - Packet access control & filtering
- STP/RSTP support for network system redundancy
- Long-distance transmission support (5 GHz channel only)
- Turbo Roaming enables rapid handover (Client/Client-Router/Slave mode)
- AeroLink Protection supported for redundant wireless communication
- ABC-01 for configuration import/export
- RS-232 console management
- 2DI+1DO for on-site monitoring and warnings
- Wide -40 to 75°C operating temperature range (-T model)
- Redundant 12 to 48 VDC power inputs or IEEE 802.3af Power over Ethernet
- DIN-Rail or wall mounting
- IP30 protected high-strength metal housing



NOTE

The latest specifications for Moxa's products can be found at <https://www.moxa.com>.



ATTENTION

The AWK-3131A is NOT a portable mobile device and should be located at least 20 cm away from the human body.

The AWK-3131A is NOT designed for the general public. A well-trained technician should be enlisted to ensure safe deployment of AWK-3131A units, and to establish a wireless network.

Patent http://www.moxa.com/doc/operations/Moxa_Patent_Marking.pdf

Functional Design

LED Indicators

The LEDs on the front panel of the AWK-3131A provide a quick and easy means of determining the current operational status and wireless settings.

The **FAULT** LED indicates system failures and user-configured events. If the AWK-3131A cannot retrieve the IP address from a DHCP server, the **FAULT** LED will blink at half second intervals. The **SIGNAL** LEDs indicate signal strength, and only operate in **Client** mode.

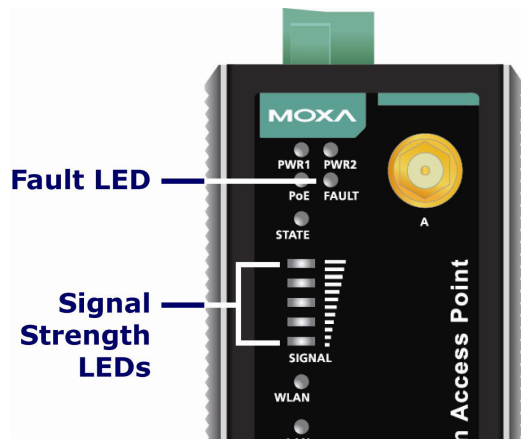

The following table summarizes how to read the device's wireless settings from the LED displays. More information is available in Chapter 3 in the "Basic WLAN Setup" section.

LED	Color	State	Description
Front Panel LED Indicators (System)			
PWR1	Green	On	Power is being supplied from power input 1.
		Off	Power is not being supplied from power input 1.
PWR2	Green	On	Power is being supplied from power input 2.
		Off	Power is not being supplied from power input 2.
PoE	Amber	On	Power is being supplied via PoE.
		Off	Power is not being supplied via PoE.
FAULT	Red	On	System is booting up, or a system configuration error or relay event has occurred.
		Blinking (fast at intervals of 0.5 second)	Cannot get an IP address from the DHCP server
		Blinking (slow at intervals of 1 second)	IP address conflict
		Off	Error condition does not exist.
STATE	Green	On	System startup is complete and the system is in operation.
		Blinking (fast at intervals of 0.5 second)	AeroLink Protection is enabled and is currently in "Backup" state
		Blinking (slow at intervals of 1 second)	Device has been located by Wireless Utility (interval: 1 second)
SIGNAL (5 LEDs)	Green	On	System is booting up
		Off	Wi-Fi Signal Level (for Client/Slave/Client-Router Modes only)
WLAN	Green	On	WLAN function is in Client/Slave/Client-Router mode and has established a link with an AP.
		Blinking	WLAN data transmission is in Client/Slave/Client-Router mode.
		Off	WLAN is not in Client/Slave/Client-Router mode or has not established a link with an AP.
	Amber	On	WLAN is in AP/Master mode.
		Blinking	WLAN data transmission is in AP/Master mode.
		Off	WLAN is not in use or not working properly
LAN	Green	On	LAN port's 1000 Mbps link is active .
		Blinking	Data is being transmitted at 1000 Mbps.
		Off	LAN port's 1000 Mbps link is inactive .
	Amber	On	LAN port's 10/100 Mbps link is active .
		Blinking	Data is being transmitted at 10/100 Mbps.
		Off	LAN port's 10/100 Mbps link is inactive .



ATTENTION

When the system fails to boot, the LEDs for **STATE** (Green), **FAULT**, and **WLAN** will all light up simultaneously and blink at one-second intervals. This may be due to improper operation or uncontrollable issues, such as an unexpected shutdown while updating the firmware. To recover the firmware, refer to the "Firmware Recovery" section in Appendix B.

Beeper

The beeper emits two short beeps when the system is ready.

Reset Button

The **RESET** button is located on the top panel of the AWK-3131A. You can reboot the AWK-3131A or reset it to factory default settings by pressing the RESET button with a pointed object such as an unfolded paper clip.

- **System reboot:** Hold the RESET button down for under 5 seconds and then release.
- **Reset to factory default:** Hold the **RESET** button down for over 5 seconds until the STATE LED starts blinking green. Release the button to reset the AWK-3131A.

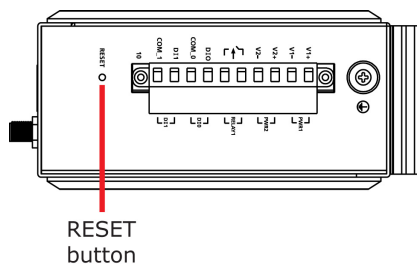

Relay (Digital Output)

The AWK-3131A has one relay output consisting of the 2 terminal block contacts on the top panel, as shown below. These relay contacts are used to forward system failures and user-configured events.

The two wires attached to the relay contacts form an open circuit when a user-configured event is triggered. If a user-configured event does not occur, the relay circuit will remain closed. For safety reasons, the relay circuit is kept open when the AWK-3131A is not powered up.

Summary of the AWK-3131A's Relay Status

Power Status	Event	Relay
Off	-	Open
On	Yes	Open
	No	Short

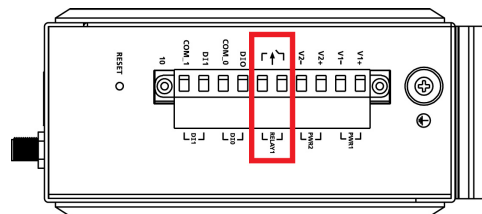

2. Getting Started

This chapter explains how to install Moxa's AirWorks AWK-3131A for the first time, and quickly set up your wireless network and test whether the connection is running well. The Function Map discussed in the third section provides a convenient means of determining which functions you need to use.

First-time Installation and Configuration

Before installing the AWK-3131A, make sure that all items in the Package Checklist are in the box. You will need access to a notebook computer or PC equipped with an Ethernet port. The AWK-3131A has a default IP address that must be used when connecting to the device for the first time.

Step 1: Select the power source.

The AWK-3131A can be powered by a DC power input or PoE (Power over Ethernet). The AWK-3131A will use whichever power source you choose.

Step 2: Connect the AWK-3131A to a notebook or PC.

Since the AWK-3131A supports MDI/MDI-X auto-sensing, you can use either a straight-through cable or crossover cable to connect the AWK-3131A to a computer. The LED indicator on the AWK-3131A's LAN port will light up when a connection is established.

Step 3: Set up the computer's IP address.

Choose an IP address on the same subnet as the AWK-3131A. Since the AWK-3131A's default IP address is **192.168.127.253**, and the subnet mask is **255.255.255.0**, you should set the IP address of the computer to **192.168.127.xxx**.



NOTE

After you select **Maintenance > Load Factory Default** and click the **Submit** button, the AWK-3131A will be reset to factory default settings and the IP address will be reset to **192.168.127.253**.

Step 4: Use the web-based manager to configure the AWK-3131A

Open your computer's web browser and type **http://192.168.127.253** in the address field to access the homepage of the web-based Network Manager. Before the homepage opens, you will need to enter the user name and password as shown in the following figure. For first-time configuration, enter the default user name and password and then click on the **Login** button:



NOTE

Default user name and password:

Username: **admin**
Password: **moxa** (starting with firmware version 1.4)
root (up to firmware version 1.3)

For security reasons, we strongly recommend changing the default password. To do so, select **Maintenance > Password**, and then follow the on-screen instructions to change the password.

Overview (Warning: Change the default password to ensure a higher level of security.)

This screen displays current active settings

System Information

Model name	AWK-3131A-US
Device name	AWK-3131A_0000



NOTE

After you click **Submit** to apply changes the web page will refresh (**Updated**) will appear on the page and a blinking reminder will be shown on the upper-right corner of the web page:



To activate the changes click **Restart** and then **Save and Restart** after you change the settings. About 30 seconds are needed for the AWK-3131A to complete the reboot procedure.

Step 5: Select the AWK-3131A operation mode.

By default, the AWK-3131A's operation mode is set to AP. You can change to Client mode in Wireless LAN Setup > WLAN > Basic WLAN Setup. Detailed information about configuring the AWK-3131A's operation can be found in Chapter 3.

Step 6: Test communications.

In the following sections we describe two test methods that can be used to ensure that a network connection has been established.

Communication Testing

After installing the AWK-3131A you can run a sample test to make sure the AWK-3131A and wireless connection are functioning normally. Two testing methods are described below. Use the first method if you are using only one AWK-3131A device, and use the second method if you are using two or more AWK-3131A units.

How to Test One AWK-3131A

If you are only using one AWK-3131A, you will need a second notebook computer equipped with a WLAN card. Configure the WLAN card to connect to the AWK-3131A (the default SSID is **MOXA**), and change the IP address of the second notebook (Notebook B) so that it is on the same subnet as the first notebook (Notebook A), which is connected to the AWK-3131A.

After configuring the WLAN card, establish a wireless connection with the AWK-3131A and open a DOS window on Notebook B. At the prompt, type

ping <IP address of notebook A>

and then press **Enter** (see the figure below). A "Reply from IP address ..." response means the communication was successful. A "Request timed out." response means the communication failed. In this case, recheck the configuration to make sure the connections are correct.

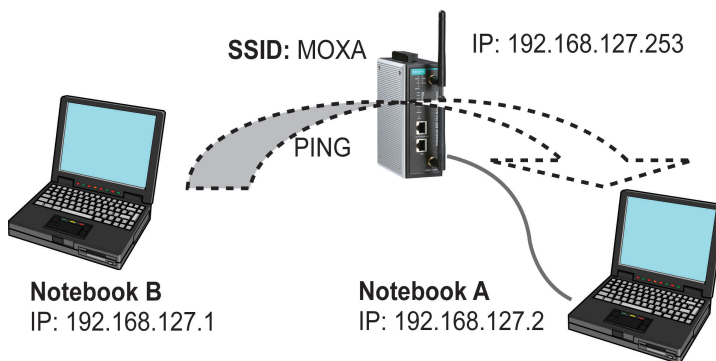

How to Test Two or More AWK-3131A Units

If you have two or more AWK-3131A units, you will need a second notebook computer (Notebook B) equipped with an Ethernet port. Use the default settings for the first AWK-3131A connected to notebook A and change the second or third AWK-3131A connected to notebook B to Client mode, and then configure the notebooks and AWK-3131A units properly.

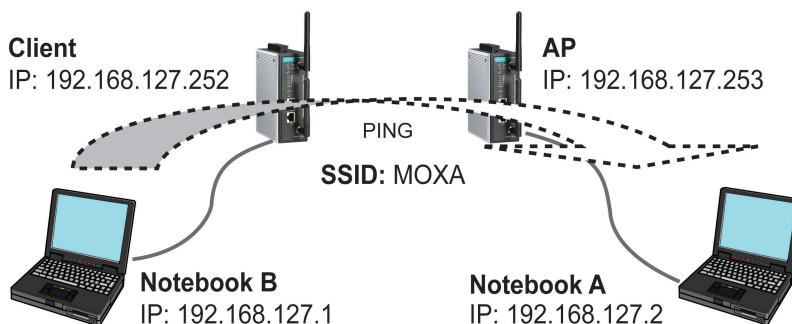

After setting up the testing environment, open a DOS window on notebook B. At the prompt, type:

ping <IP address of notebook A>

and then press **Enter**. A "Reply from IP address ..." response means the communication was successful. A "Request timed out" response means the communication failed. In this case, recheck the configuration to make sure the connections are correct.

Function Map

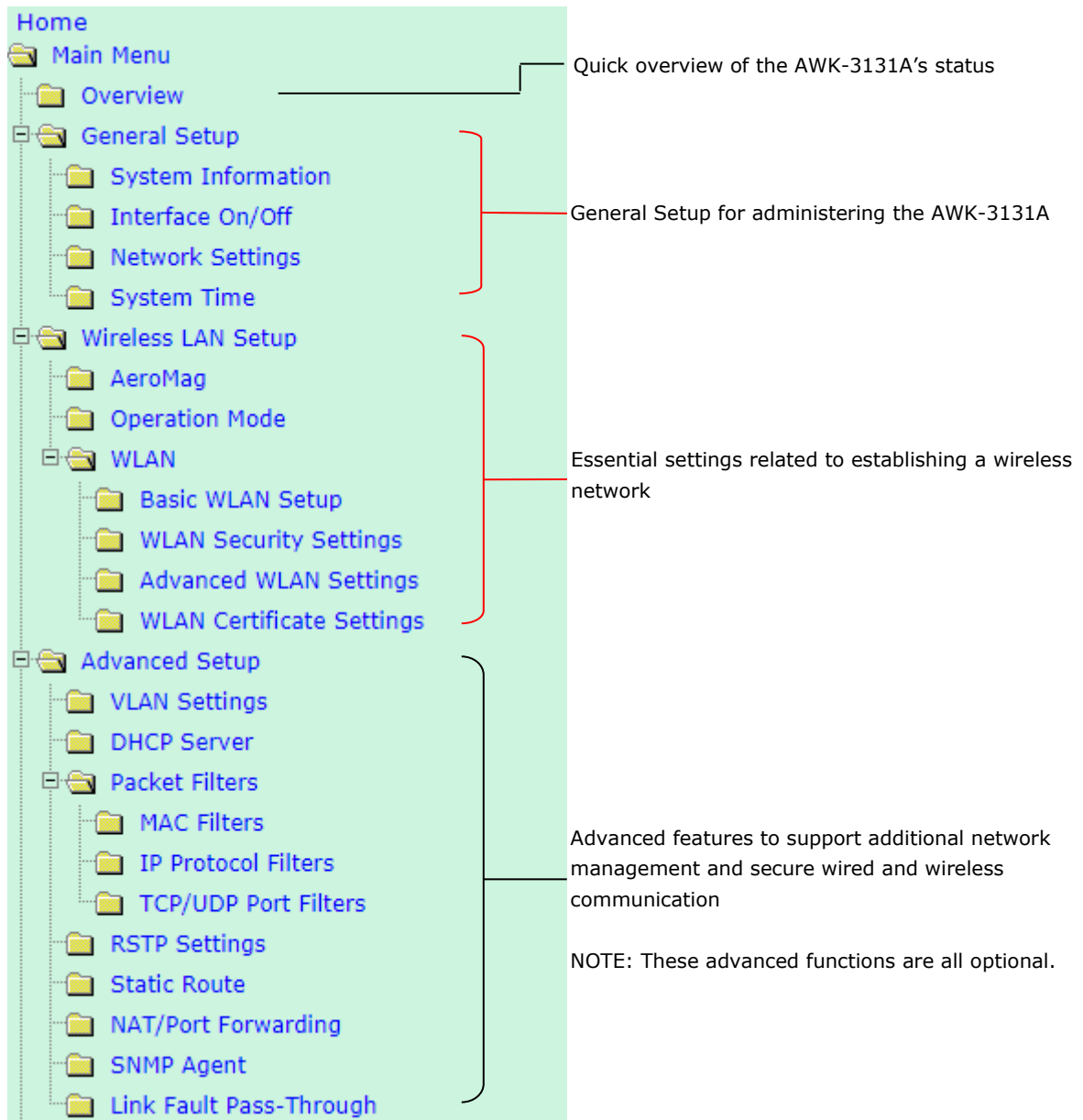

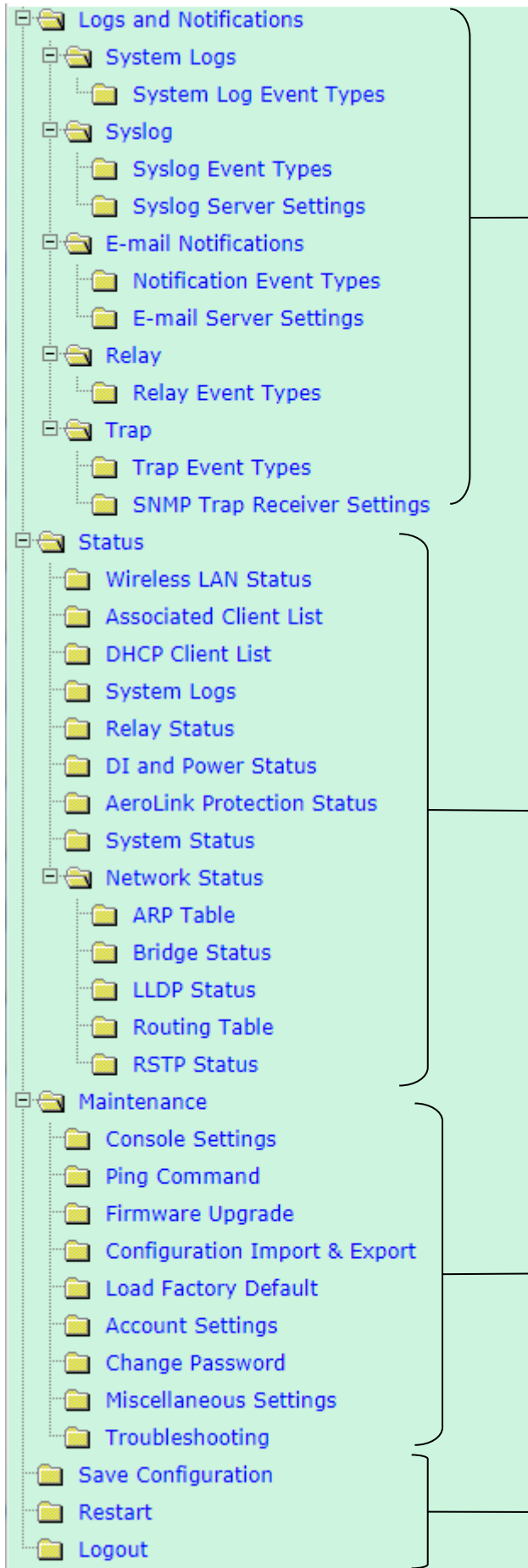

Application-oriented device management functions to set up events, traps, and reactions via relay warning, e-mail, and SNMP notification

NOTE: These functions are all optional.

Current status information for monitoring wired/wireless network performance, advanced services, and device management functions.

Functions for maintaining the AWK-3131A, and for diagnosing the network.

On-demand functions to support the web-based console management operation.

The management functions are categorized in a tree and shown in the left field of the web-based management console. You can efficiently locate the function you need with this guide.

3. Web Console Configuration

In this chapter, we explain all aspects of web-based console configuration. Moxa's easy-to-use management functions help you set up your AWK-3131A and make it easy to establish and maintain your wireless network.

Web Browser Configuration

Moxa AWK-3131A's web browser interface provides a convenient way to modify its configuration and access the built-in monitoring and network administration functions. The recommended web browser is Chrome version 109.0.5414.120 (Official Build, 64-bit).



NOTE

To use the AWK-3131A's management and monitoring functions from a PC host connected to the same LAN as the AWK-3131A, you must make sure that the PC host and the AWK-3131A are on the same logical subnet. Similarly, if the AWK-3131A is configured for other VLAN settings, you must make sure your PC host is on the management VLAN.

Moxa AWK-3131A's default IP is **192.168.127.253**.

Follow these steps to access the AWK-3131A's web-based console management interface.

1. Open your web browser (e.g., Internet Explorer) and type the AWK-3131A's IP address in the address field. Press **Enter** to establish the connection.

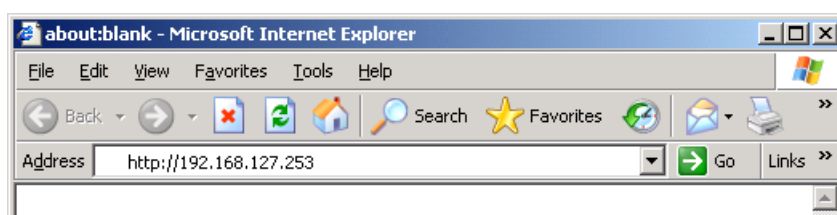

2. The Web Console Login page will open. Enter the password (default Username = **admin**; default Password = **moxa**) and then click **Login** to continue.

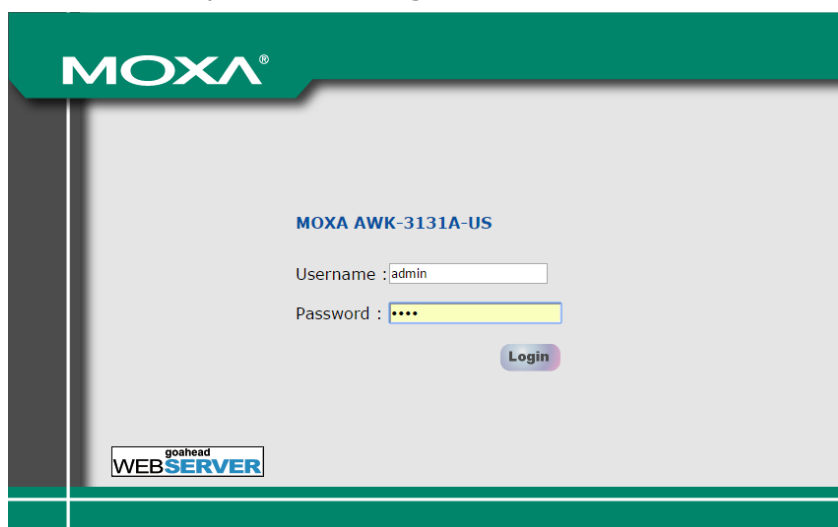

- You may need to wait a few moments for the web page to download to your computer. Note that the Model name and IP address of your AWK-3131A are both shown in the title bar of the web page. This information can be used to help you identify multiple AWK-3131A units.

If an incorrect username or password is entered, a warning message is displayed. The system will lock the user account based on the settings configured in the **Maintenance > Account Settings** page. The default retry count is 5 times and the default lockout time is 600 seconds.

Once an account is locked, the user will have to wait out the duration of the lockout period before retrying.

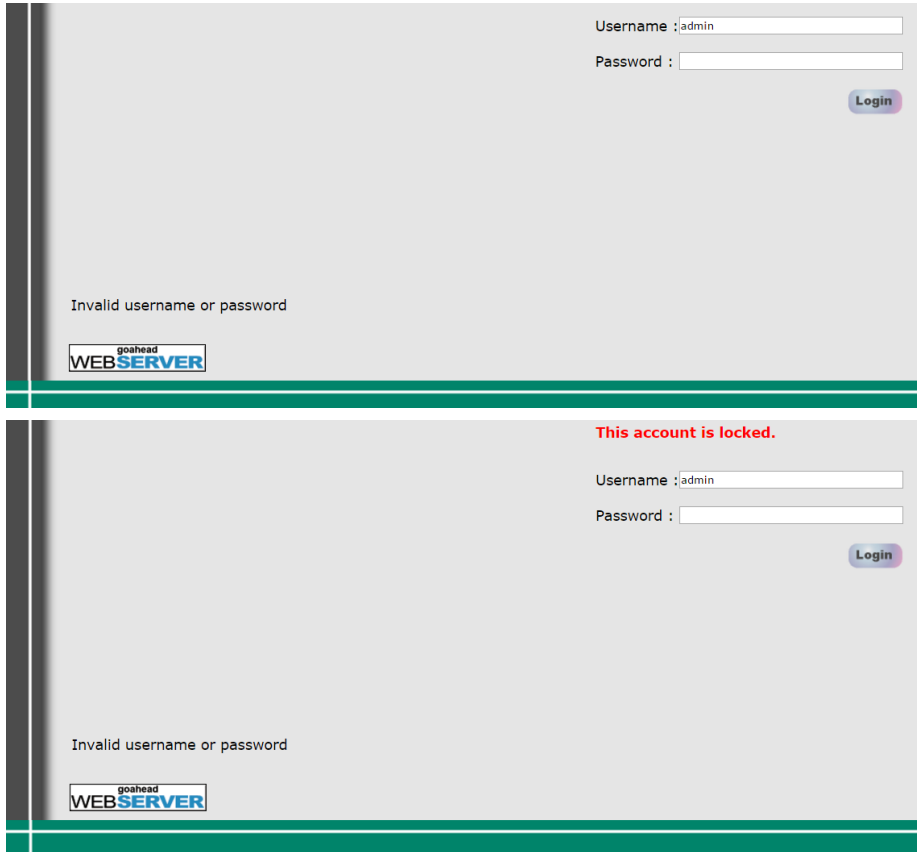

- Use the **Quick Setup** function on the homepage to quickly set up the AWK or click on the **Overview** button to see the basic device settings. The **Import/Export** function helps you back up the system or to perform a system recovery from an existing backup.

<p>Home</p> <ul style="list-style-type: none"> Main Menu <ul style="list-style-type: none"> Overview General Setup Wireless LAN Setup Serial Port Settings Advanced Setup Logs and Notifications Status Maintenance <ul style="list-style-type: none"> Save Configuration Restart Logout 	<div style="border: 1px solid black; background-color: #008000; color: white; padding: 5px; width: 100px; margin: 5px auto;">Quick Setup</div>	<p>Click "Quick Setup" to configure your AWK in three simple steps.</p>
	<div style="border: 1px solid black; background-color: #008000; color: white; padding: 5px; width: 100px; margin: 5px auto;">Import/Export</div>	<p>Click "Import/Export" to perform configuration backup or recovery.</p>
	<div style="border: 1px solid black; background-color: #008000; color: white; padding: 5px; width: 100px; margin: 5px auto;">Overview</div>	<p>Click "Overview" to view the AWK's basic device information.</p>

- Click on the **Home** link to go back to the main page.
Use the menu tree on the left side of the browser to open the AWK-3131A functions.

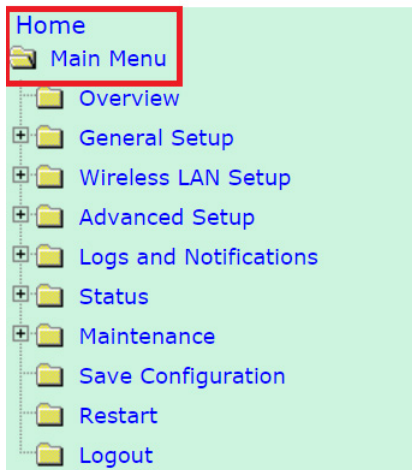

In the following paragraphs, we describe each AWK-3131A management function in detail. A quick overview is available in this manual in the "Function Map" section of Chapter 3.



NOTE

The model name of the AWK-3131A is shown as AWK-3131A-XX, where XX indicates the country code. The country code indicates the AWK-3131A version and which frequencies it uses. We use **AWK-3131A-US** as an example in the following figures. (The country code and model name that appears on your computer screen may be different than the one shown here.)

Overview

The **Overview** page summarizes the AWK-3131A's current status. The information is categorized into several groups: **System Information**, **Device Information** and **802.11 Information**.

MOXA® www.moxa.com

Home
Main Menu
Overview
General Setup
Wireless LAN Setup
Advanced Setup
Logs and Notifications
Status
Maintenance
Save Configuration
Restart
Logout

Overview (Warning: Change the default password to ensure a higher level of security.)

This screen displays current active settings

System Information	
Model name	AWK-3131A-US
Device name	AWK-3131A_7286
Serial number	7286
System uptime	0 days 00h:01m:51s
Firmware version	1.6 Build 17091517
Device Information	
Device MAC address	00:90:E8:62:BB:89
IP address	192.168.127.253
Subnet mask	255.255.255.0
Gateway	
802.11 Information	
Country code	US
Operation mode	AP
Channel	6
RF type	B/G/N Mixed
Channel width	N/A
SSID	MOXA

Click on the SSID link (MOXA) to see more detailed information on 802.11 settings, as shown in the following figure:

Wireless LAN Status

Auto Update

Show status of WLAN (SSID: MOXA) ▾

802.11 Information	
Operation mode	AP
Channel	6
Channel width	N/A
RF type	B/G/N Mixed
SSID	MOXA
MAC	06:90:E8:11:22:33
Security mode	OPEN
Current BSSID	N/A
Signal strength	N/A
Signal strength	-108 dBm
Noise floor	-108 dBm
SNR	N/A
Transmission Information	
Rate	Auto
Power	20 dBm
Outgoing Packets	
Total sent	0
Packets with errors	0
Packets dropped	9154
Incoming Packets	
Total received	0
Packets with errors	0
Packets dropped	0



NOTE

The **802.11 Information** that is displayed may be different for different operation modes. For example, **Current BSSID**, **Signal strength**, and **SNR** are only available under Client/Client-Router/Slave operation modes.

Quick Setup

The AWK-3131A provides a quick setup wizard to help you configure the basic settings including device information and wireless settings.

Once you enter the setup, links to each step in the process are displayed at the top of the page. You can either click **Next** to go to the next step or click directly on a link at the top of the page to go to a specific step.

The screenshot shows the 'Device Info. and IP Settings' step of the Quick Setup wizard. At the top, a progress bar indicates the current step (1) and subsequent steps (2-1, 2-2, 2-3, 3). The form is divided into several sections:

- Device Information:** Device name: AWK-3131A_0000
- System Time:** Current local time: 2017 / 01 / 21 13 : 04 : 23 (YYYY/MM/DD HH:MM:SS). A 'Set Time' button is present with a note: '(Note that "Set Time" would cause re-login.)'
- Time protocol:** SNTP
- Time server:** time.nist.gov
- Time zone:** (GMT)Greenwich Mean Time: Dublin, Edinburgh, Lisbon, London
- Daylight saving time:** Enable
- IP Settings:** IP address assignment: Static. IP address: 192.168.127.253. Subnet mask: 255.255.255.0. Gateway: (empty)
- User Settings:** Account name: admin. Current password, New password, and Confirm password fields are present with question mark icons.

At the bottom, there are 'Cancel', 'Back', and 'Next' buttons.



NOTE

You can move your cursor on the question mark symbol next to a field to view a tooltip that provides additional details regarding the corresponding field.

This screenshot shows a close-up of the 'User Settings' section. The 'Account name' field contains 'admin'. A red box highlights a green tooltip that appears next to the question mark icon, containing the text: 'This is the 1st account. It is always in Admin group.'

In the **Wi-Fi Settings** step, you can either use **Manual** to manually configure the basic Wi-Fi settings or click **AeroMag** to opt for AeroMag to automatically set up your Wi-Fi network.

The screenshot shows the 'Wi-Fi Settings' step of the Quick Setup wizard. The progress bar at the top highlights step 2-1. Below the progress bar, there are two main options:

- Manual:** Configure your wireless communication in 3 simple steps.
- AeroMag:** Use AeroMag to enable your wireless topology.

At the bottom, there are 'Cancel' and 'Back' buttons.

For additional details on the AeroMag function, refer to the Wireless LAN Setup section. Note that Quick Setup does not support AeroMag for client-router mode.

If you use the **Manual** option to configure basic Wi-Fi settings, use the channel survey provided in the **Channel Usage** section to find out if a channel is clear or congested. This function can help you deploy a clear channel without requiring the use of a channel analysis tool.

Channel Usage

Channel Survey Survey ?

Channel Usage Result - 2.4 GHz

Channel	1	2	3	4	5	6	7
Number of APs	1	0	1	0	0	1	0
Load (%)	3	70	70	7	6	17	33
Noise floor (dBm)	-107	-107	-107	-107	-107	-107	-108
Channel	8	9	10	11	--	--	--
Number of APs	0	0	0	14	--	--	--
Load (%)	4	14	29	34	--	--	--
Noise floor (dBm)	-107	-109	-105	-106	--	--	--

Channel Usage Result - 5 GHz

Channel	36	40	44	48	52	56	60
Number of APs	8	2	3	1	0	0	1
Load (%)	3	1	1	1	0	0	1
Noise floor (dBm)	-113	-115	-116	-114	-115	-115	-115
Channel	64	100	104	108	112	116	120
Number of APs	0	0	0	0	0	0	1
Load (%)	0	0	0	0	0	0	1
Noise floor (dBm)	-114	-115	-115	-115	-116	-116	-117
Channel	124	128	132	136	140	149	153
Number of APs	1	1	0	0	0	3	3
Load (%)	79	57	0	0	15	6	7
Noise floor (dBm)	-115	-117	-117	-117	-112	-116	-117
Channel	157	161	165	--	--	--	--
Number of APs	3	12	6	--	--	--	--
Load (%)	1	17	3	--	--	--	--
Noise floor (dBm)	-117	-116	-117	--	--	--	--

Setting	Description
Number of APs	The number of APs which use this channel
Load	A measure of how congested a channel is, in percentage value. Both 802.11 and non-802.11 signals will affect the channel loading.
Noise floor	A summation of the noise level from all sources

You can see a complete preview of the Wi-Fi parameters that you configured when you click on the final step in the setup process (**Review Settings**).

1. Device Info. and IP Settings >>> 2-1. Wi-Fi Settings >>> 2-2. Security >>> 2-3. Turbo Roaming (Client Only) >>> 3. Review Settings

Device Info. and IP Settings

Device name	AWK-3131A_0000
IP address assignment	Static
IP address	192.168.127.253
Subnet mask	255.255.255.0
Gateway	
Account name	admin

Wi-Fi Settings

Operation mode	AP
SSID	MOXA
RF type	BGNMixed
Security mode	OPEN

If more detailed configuration is required, click "Submit" to link to access the standard setup page.

Cancel Back Submit Save and Restart

General Setup

The **General Setup** group includes the most commonly used settings required by administrators to maintain and control the AWK-3131A.

System Information

The **System Information** items, especially **Device name** and **Device description**, are displayed and included on the **Overview** page, in SNMP information, and in alarm emails. Setting **System Information** items makes it easier to identify the different AWK-3131A units connected to your network.

System Information

Device name	AWK-3131A_0000
Device location	
Device description	
Device contact information	
Login Message	
Login authentication failure message	Invalid username or password

Submit

Device name

Setting	Description	Factory Default
Max. 31 of characters	This option is useful for specifying the role or application of different AWK-3131A units.	Model name_<Last 3 bytes of the device MAC>

Device location

Setting	Description	Factory Default
Max. of 31 characters	Specifies the location of different AWK-3131A units.	None

Device description

Setting	Description	Factory Default
Max. of 31 characters	Use this space to record a more detailed description of the AWK-3131A	None

Device contact information

Setting	Description	Factory Default
Max. of 31 characters	Provides information about whom to contact in order to resolve problems. Use this space to record contact information of the person responsible for maintaining this AWK-3131A.	None

Login Message

Setting	Description	Factory Default
Max. of 31 characters	Enter a message to display to all users when they log in	Blank

Login authentication failure message

Setting	Description	Factory Default
Max. of 31 characters	Enter the login authentication failure message to display to the user who logs in with an invalid username or password	None

Interface On/Off

Interface On/Off

LAN Enable Disable

Network Settings

The Network Settings configuration panel allows you to modify the usual TCP/IP network parameters. However, due to the addition of the Client-Router operation mode, this panel provides two different sets of network parameters. Explanations for both types of configuration are given below.

Network Settings for AP/Client/Master/Slave Operation Modes

Network Settings

IP address assignment Static ▾

IP address DHCP 192.168.43.104

Subnet mask Static 255.255.252.0

Gateway 192.168.43.254

Primary DNS server 192.168.50.41

Secondary DNS server 192.168.50.42

IP address assignment

Setting	Description	Factory Default
DHCP	The AWK-3131A's IP address will be assigned automatically by the network's DHCP server	Static
Static	Set up the AWK-3131A's IP address manually.	

IP address

Setting	Description	Factory Default
AWK-3131A's IP address	Identifies the AWK-3131A on a TCP/IP network.	192.168.127.253

Subnet mask

Setting	Description	Factory Default
AWK-3131A's subnet mask	Identifies the type of network to which the AWK-3131A is connected (e.g., 255.255.0.0 for a Class B network, or 255.255.255.0 for a Class C network).	255.255.255.0

Gateway

Setting	Description	Factory Default
AWK-3131A's default gateway	The IP address of the router that connects the LAN to an outside network.	None

Primary/ Secondary DNS server

Setting	Description	Factory Default
IP address of the Primary/Secondary DNS server	The IP address of the DNS Server used by your network. After entering the DNS Server's IP address, you can input the AWK-3131A's URL (e.g., http://ap11.abc.com) in your browser's address field instead of entering the IP address. The Secondary DNS server will be used if the Primary DNS server fails to connect.	None

MTU

Setting	Description	Factory Default
576 to 2290	MTU (Maximum Transmission Unit) refers to the maximum size of an IP packet that can be transmitted without fragmentation over a given medium.	1500



NOTE

The MTU setting applies to all networking interfaces including Ethernet and Wi-Fi interfaces.

Network Settings for Client-Router Operation Mode

Network Settings

WLAN (Default Route)

IP address assignment Static ▼

IP address

Subnet mask

Gateway

Primary DNS server

Secondary DNS server

LAN

IP address

Subnet mask

WLAN IP address assignment

Setting	Description	Factory Default
DHCP	The AWK-3131A WLAN interface's IP address will be assigned automatically by the network's DHCP server	Static
Static	Set up the AWK-3131A WLAN interface's IP address manually.	

WLAN IP address

Setting	Description	Factory Default
AWK-3131A WLAN interface's IP address	Identifies the AWK-3131A WLAN interface's IP address on a TCP/IP network.	192.168.128.253

WLAN subnet mask

Setting	Description	Factory Default
AWK-3131A WLAN interface's subnet mask	Identifies the type of network to which the AWK-3131A's WLAN interface is connected (e.g., 255.255.0.0 for a Class B network, or 255.255.255.0 for a Class C network).	255.255.255.0

WLAN gateway

Setting	Description	Factory Default
AWK-3131A WLAN interface's default gateway	The IP address of the router that connects the WLAN to an outside network.	None

Primary/Secondary DNS server

Setting	Description	Factory Default
IP address of the Primary/Secondary DNS server	The IP address of the DNS Server used by your network. After entering the DNS Server's IP address, you can input the AWK-3131A's URL (e.g., http://ap11.abc.com) in your browser's address field instead of entering the IP address. The Secondary DNS server will be used if the Primary DNS server fails to connect.	None

LAN IP address

Setting	Description	Factory Default
AWK-3131A LAN interface's IP address	Identifies the AWK-3131A LAN interface's IP address on a TCP/IP network.	192.168.127.254

LAN subnet mask

Setting	Description	Factory Default
AWK-3131A LAN interface's subnet mask	Identifies the type of network to which the AWK-3131A's LAN interface is connected (e.g., 255.255.0.0 for a Class B network, or 255.255.255.0 for a Class C network).	255.255.255.0

MTU

Setting	Description	Factory Default
576 to 2290	MTU (Maximum Transmission Unit) refers to the maximum size of an IP packet that can be transmitted without fragmentation over a given medium.	1500



NOTE

The MTU setting applies to all networking interfaces including Ethernet and Wi-Fi interfaces.

System Time

The AWK-3131A has a time calibration function based on information from an NTP server or user specified Date and Time information. Functions such as **Logs and Notifications** can add real-time information to the message.

System Time

Date (YYYY/MM/DD) **Time (HH:MM:SS)**

Current local time 2015 / 05 / 29 08 : 11 : 54

Time protocol SNTP

Time zone (GMT)Greenwich Mean Time: Dublin, Edinburgh, Lisbon, London ▼

Daylight saving time Enable

Time server 1 time.nist.gov

Time server 2

Time sync interval 600 (600~9999 seconds)

The **Current local time** shows the AWK-3131A's system time when you open this web page. You can click on the **Set Time** button to activate the updated date and time parameters. An "(Updated)" string will appear to indicate that the change is complete. Local system time will be immediately activated in the system without running Save and Restart.



NOTE

The AWK-3131A has a built-in real time clock (RTC). We strongly recommend that users update the **Current local time** for the AWK-3131A after the initial setup or a long-term shutdown, especially when the network does not have an Internet connection for accessing the NTP server or there is no NTP server on the LAN.

Current local time

Setting	Description	Factory Default
User adjustable time	The date and time parameters allow configuration of the local time, with immediate activation. Use 24-hour format: yyyy/mm/dd hh:mm:ss	None

Time zone

Setting	Description	Factory Default
User selectable time zone	The time zone setting allows conversion from GMT (Greenwich Mean Time) to local time.	GMT (Greenwich Mean Time)



ATTENTION

Changing the time zone will automatically adjust the **Current local time**. You should configure the **Time zone** before setting the **Current local time**.

Daylight saving time

Setting	Description	Factory Default
Enable/ Disable	Daylight saving time (DST or summer time) involves advancing clocks (usually 1 hour) during the summer time to provide an extra hour of daylight in the afternoon.	Disable

When **Daylight saving time** is enabled, the following parameters will be shown:

- **Starts at:** The date that daylight saving time begins.
- **Stops at:** The date that daylight saving time ends.
- **Time offset:** Indicates how many hours forward the clock should be advanced.

Time server 1/2

Setting	Description	Factory Default
IP/Name of Time Server 1/2	IP or Domain name of the NTP time server. The 2nd NTP server will be used if the 1st NTP server fails to connect.	time.nist.gov

Time sync interval

Setting	Description	Factory Default
Time interval for NTP server synchronization (600 to 9999 seconds)	This parameter determines how often the time is synchronized from the NTP server.	600 (seconds)

Wireless LAN Setup

The AWK-3131A provides two different sets of wireless operation modes: AP/client modes for point-to-multipoint communication and master/slave modes for transparent point-to-point communication. The major differences between these two operation modes are the MAC address translation on the client/slave radio.

AP/client: The IP-Bridging mechanism is used to overcome limitations of the 802.11 standards. In this case, the MAC address of the devices connected to the client radio will be replaced with the client's MAC address. Under AP/client modes, communication problems might be encountered when you have a MAC authenticated system or MAC (Layer 2) based communication. In this case, you will need to change the network to use the master/slave operation mode.

Master/slave: A transparent point-to-point protocol that allows the devices' MAC addresses to remain unchanged when the packets get through the slave radio. If you are looking for a worry-free wireless solution to replace your wired system, use Master/Slave.

Client-router: A variation of standard client mode. WLAN behavior is identical with client mode, but a router behavior was added to separate the WLAN and LAN subnets. This allows network planners to allocate private IP addresses behind the client radio. More information on the Static Route, NAT, and Port Forwarding functions can be found in the **Advanced Setup** section.

Sniffer: In order to provide an easier way for our customers to analyze wireless traffic, the AWK-3131A supports a "Sniffer" mode to co-work with Wireshark packet sniffer software.



NOTE

Although it is more convenient to use dynamic bridging, there is a limitation—the Client can only transmit IP-based packets between its wireless interface (WLAN) and Ethernet interface (LAN); other types of traffic (such as IPX and AppleTalk) are not forwarded.

AeroMag

Moxa's AeroMag tool enables fast, automatic, and error-free configuration of basic Wi-Fi settings based on the current wireless environment and location of the APs. The AWK-3131A can be used as the AeroMag client or client-router and either an AWK-3131A or an AWK-4131A can be used as AeroMag APs.

Concept

Moxa's AeroMag technology takes care of the basic Wi-Fi settings for you, saving you considerable effort when deploying your wireless networks. AeroMag is a useful tool throughout the Wi-Fi network lifecycle. When you are configuring network devices, AeroMag sets up your Wi-Fi connections correctly in a single step. During the installation phase, AeroMag streamlines network operation by analyzing the optimal channel for your current operating environment. From a maintenance perspective, new APs/clients can join the AeroMag topology without any additional configuration.

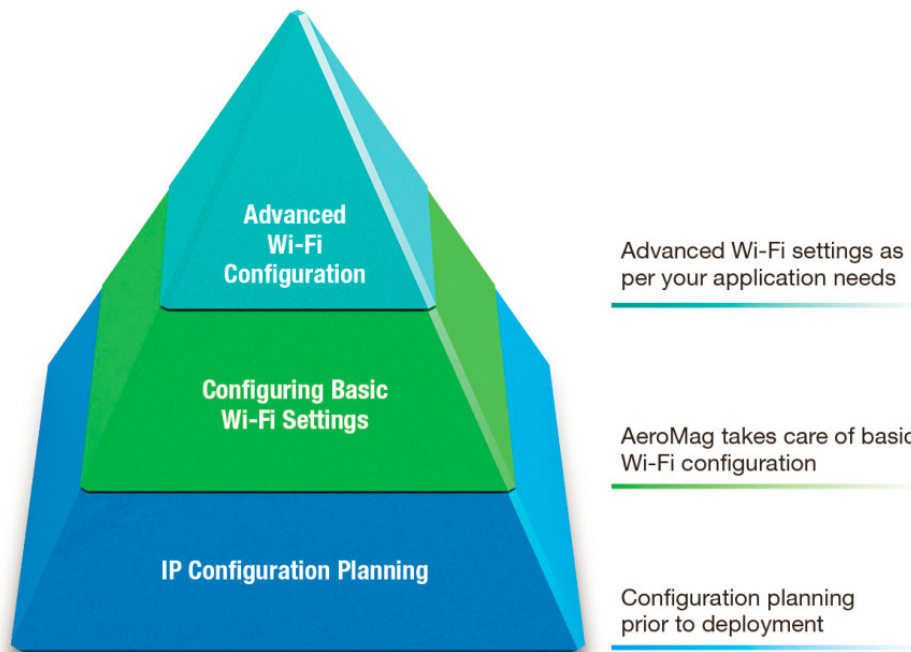

Once you have confirmed the number of APs and their location, using a site-survey tool, and have configured their device names and IP addresses, connect all the APs to the same network using Layer-2 switches. Next, activate the AeroMag function on both the APs and clients.

AeroMag decides the optimized RF type, channels, WPA2 password, and SSID for you. AeroMag APs will generate an optimal configuration and assign it to AeroMag Clients. AeroMag Clients search AeroMag APs to achieve the optimal configuration.

AeroMag

AeroMag operation mode

Inactive ▼
 AP
 Client
 Client-Router
 Inactive

Setting Up the Device as an AeroMag AP

The AeroMag function is inactive by default. In the AWK-3131A, both the AP and the client modes are available under the AeroMag function. To activate AeroMag, set the **AeroMag operation mode** to **AP**.

AeroMag

AeroMag operation mode AP ▾

Apply AeroMag configuration Use the current configuration Generate a new configuration

Lock AeroMag Topology ?

Auto Update: Update after 21 secs ...

AeroMag AP Operating Status

AeroMag Operating Stage	Status
Grouping	Done
Generating Configuration	Done
Alignment Configuration	Done
Ready for new APs/Clients deploying	Done
Refresh Channel	Ready

AP Settings

SSID	MOXA_ulnm0W4hm	Password	*****
RF Type	A/N Mixed	Channel	36, 48(*), 165

Channel arrangement

36	48	165
N/A	06:90:E8:11:22:33	N/A

AeroMag Unit Logs

No.	Timestamp	Source Device	Joining Device	Mode	Joining Status
1	2017/01/14,07h:49m:31s	AWK-3131A_0000 (06:90:E8:11:22:33)	AWK-3131A_0000 (06:90:E8:11:22:33)	AP	Done

Setting Up the Device as an AeroMag Client/Client-router

Set the **AeroMag operation mode** to **Client** or **Client-Router**.

AeroMag

AeroMag operation mode Client ▾

Apply AeroMag configuration Use the current configuration Generate a new configuration

Auto Update

AeroMag Client Operating Status

AeroMag Operating Stage	Status
Find AeroMag AP	Found
Identity Verification	100%
Apply Configuration	Done

AP Settings

SSID	MOXA_Be3vWNs5	Password	<input type="checkbox"/> *****
RF type	ANMixed	Channel	40 48 161



NOTE

You can also activate AeroMag through MXconfig, SNMP, or by using the **Reset** button on the device. Press the **Reset** button on the AWK-3131A **four times** to activate the AeroMag AP. Press the **Reset** button five times to activate the AeroMag client. Press the **Reset** button three times to deactivate AeroMag (each consecutive press should be affected within 2 seconds of the previous one). You can activate either the AP first or the Client first as the order does not affect the behavior of the AeroMag tool.

After the AeroMag function is activated, configure the following:

Setting	Description	Factory Default
Apply AeroMag configuration	<ul style="list-style-type: none"> <i>Use the current configuration:</i> Use the current configuration generated by AeroMag. This option is only available if AeroMag was already active once before the current configuration change. If you are activating AeroMag for the first time, this option will not be available. <i>Generate a new configuration:</i> AeroMag AP: Discard the current configuration settings and generate a new set consisting of SSID, WAP2 password, RF type and search for the three best channels. AeroMag Client/Client-Router: Discard current configuration settings and search for an AeroMag AP to get a new set of configuration settings. 	<i>Generate a new configuration</i>
Lock AeroMag Topology	<p>When this option is selected, no additional AP/Client is allowed to join this AeroMag topology and receive a new set of configuration settings. The statuses of all additional devices trying to join the AeroMag topology are indicated using a lock symbol.</p> <p>NOTE 1: The Lock AeroMag Topology function is activated immediately without the need to submit the changes and reboot the device.</p> <p>NOTE 2: You can trigger the Lock AeroMag Topology function for all units in an AeroMag topology by accessing any one of the AeroMag APs in the topology.</p>	<i>Inactive</i>
Refresh Channel	<p>All APs in an AeroMag topology will search for the three best channels when the Refresh Channel function is triggered. If the new set of channels is different from the existing one, AeroMag APs will use the latest configuration generated and will inform the AeroMag clients to change their Turbo Roaming channels to the three channels defined by AeroMag.</p> <p>NOTE: The Refresh Channel function is activated immediately and does not need a submit action or a device reboot. You can trigger this function from any AP in an AeroMag topology and the function will be triggered for all units in the topology.</p>	

You can also view the **AeroMag AP/Client Operating Status** listed below:



NOTE

Select the **Auto Update** option for AeroMag to refresh the AeroMag Operating Status every 30 seconds. When channels are refreshed or a new configuration is generated, selecting the Auto Update option will refresh an AP's operating status every 5 seconds.

AeroMag AP Operating Status

Parameter	Description
Grouping	The AeroMag APs find other which that are also connected to the same L2 subnet. They mark themselves as a group with same SSID. One AP among them would act as Master AeroMag AP.
Generating Configuration	The master AeroMag AP generates a new configuration using the spectrum report received from all AeroMag APs
Alignment Configuration	All AeroMag APs align configuration which is distributed by Master AeroMag AP
Ready for new APs/Clients deploying	Ready for offering configuration to new coming APs/Clients
Refresh Channel	Whether Refresh Channel Function is ready

AeroMag Client/Client-router Operating Status

Parameter	Description
Find AeroMag AP	AeroMag Client searches for an AeroMag AP
Identity Verification	AeroMag Client sends a connection authentication request to the AeroMag AP for the AP to verify if the client is a Moxa device.
Apply Configuration	The configuration generated by the AeroMag AP and sent to the client, after a successful authentication of the client, is applied to this client.
AP Settings	Shows the AeroMag AP that this client is connected to and the assigned configuration

AeroMag views a topology where the wireless devices with the same SSID are grouped together. If you need to assign a specific SSID to devices, you must first deactivate AeroMag and then change each AWK's SSID. The new SSID for each device will become the group index the next time you activate the AeroMag function.

Password	<input type="checkbox"/> *****
Channel	36, 48(*), 165
Password	<input checked="" type="checkbox"/> IWsE9WeyHFem9bHh63NdvWjT
Channel	36, 48(*), 165

For a higher level of security, the password parameter can only be viewed over HTTPS by a user with an **Admin** account. No user can read the password over HTTP, not even an **Admin** account.

The **Channel** value displays the current channels that the AeroMag APs are operating in. The channel set is updated when the current AeroMag APs change their operating channels when **Refresh Channel** is triggered.

Parameter	Description
Channel Arrangement	Indicate the channel used by every AeroMag AP in this topology along with their MAC addresses
AP Settings	Shows the configuration that the AeroMag APs are using right now. The channel marked with an asterisk is the channel used by this AeroMag AP.

AeroMag Unit Logs

Parameter	Description
Timestamp	The timestamp when the event was last triggered.
Source Device	The AeroMag unit that provides the configuration of the unit joining the topology
Joining Device	The devices that are trying to join this topology
Mode	Operation mode used by the device trying to join this topology
Joining Status	The status of joining behavior.
Clear	Use this option to clear the log contents

If the AeroMag APs or Clients are trying to join a topology that has been locked by AeroMag, the status will show **Block**. You should unlock the existing AeroMag topology in order to add new units. Channel-refreshing is recommended in order to optimize the channel arrangement whenever there are some new units added to the topology.



NOTE

1. An AeroMag AP allows normal Wi-Fi Clients to connect to it as long as they use the same SSID and same WAP2 settings. AeroMag will help you quickly set up the basic settings in your Wi-Fi network without changing the standard Wi-Fi behavior.
2. An AeroMag client CANNOT search and connect to a normal AP because of a null configuration during the search.
3. If two active groups of devices in an AeroMag topology connect to the same subnet network when the lock down feature is not activated, the two groups will merge and take the SSID, WAP2 password, and channels settings of one of the groups.
4. When AeroMag APs discard their configuration due to group merge, the corresponding AeroMag clients will also discard their configuration to search for new AeroMag APs.
5. We highly recommend locking down your AeroMag topology once the topology is established as planned in order to prevent unexpected AeroMag units from joining this topology.
6. We highly recommend refreshing the channels right after first installing the devices on-site the first time.
7. When AeroMag is active, you cannot change the Basic WLAN and Security Setup manually.
8. If you would like to set your own SSID but would like to benefit from the AeroMag function at the same time, we recommend that you activate one AeroMag AP and then change the SSID to the one you want to set. Next, connect all the other units so that the AeroMag topology can be grouped with a manually assigned SSID.
9. If an AeroMag client is informed that the Turbo Roaming channel needs to be changed due to a **Refresh Channel** action triggered by AeroMag APs, the Wi-Fi connection with the client will be disconnected for 180 seconds, until the client reconnects to an AP.
10. If an AeroMag client is disconnected from an AeroMag AP and fails to find an AeroMag AP within the Turbo Roaming channels within 150 seconds, the client starts to scan all channels for AeroMag APs to recover its AeroMag connection.
11. If an AeroMag client loses a connection for 10 minutes and fails to connect again, the AeroMag client discards the current configuration and starts searching for AeroMag APs all over again.
12. AeroMag devices in a network must operate in the same regulatory band. For example, if one AeroMag unit uses US band and the others unit use EU band, AeroMag will fail to establish a network topology.

Operation Mode

The AWK-3131A supports six operation modes—AP, Client, Client-Router, Master, Slave, and Sniffer—each of which plays a distinct role on the wireless network.

Wireless enable

Setting	Description	Factory Default
Enable/Disable	The RF (Radio Frequency) module can be manually turned on or off.	Disable

Operation mode

Setting	Description	Factory Default
AP	The AWK-3131A plays the role of wireless Access Point	AP
Client	The AWK-3131A plays the role of wireless Client	
Client-Router	The AWK-3131A plays the role of wireless Client, but includes the router function to divide the WLAN and LAN interfaces into two subnets.	
Master	The AWK-3131A plays the role of wireless Master.	
Slave	The AWK-3131A plays the role of wireless Slave.	
Sniffer	Turns the device into a remote Wireshark interface to capture 802.11 packets for analysis.	

Sniffer mode instructions:

1. Set operation mode to Sniffer mode on the AWK-3131A and then save/reboot the device.
2. Connect the AWK-3131A to a laptop with Wireshark installed (v1.12.0 or later release) via Ethernet.
3. Add a remote interface by entering the IP address of the AWK-3131A.

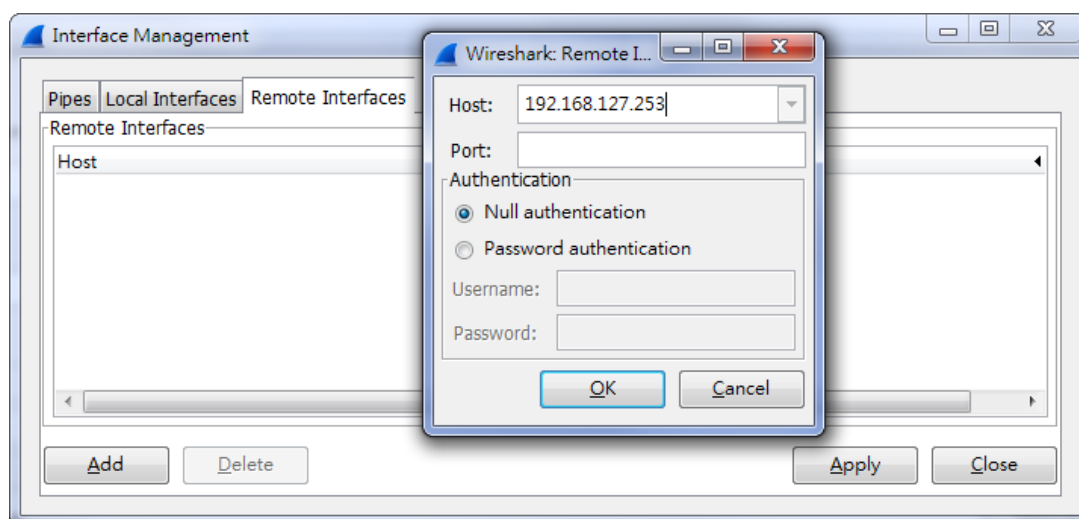

Detailed Wireshark instructions can be found at:

https://www.wireshark.org/docs/wsug_html_chunked/ChCapInterfaceRemoteSection.html

4. Start capturing the 802.11 wireless packets with Wireshark.

Basic WLAN Setup

The "Basic WLAN Setup" panel is used to add and edit SSIDs. An SSID is a unique identifier that wireless networking devices use to establish and maintain wireless connectivity. Multiple access points on a network or sub-network can use the same SSIDs. You can configure your AWK to use up to 9 SSIDs. All of the SSIDs are active at the same time; that is, client devices can use any of the SSIDs to associate with the access point.

Basic WLAN Setup (Multiple SSID)			
Status	SSID	Operation Mode	Action
Active	MOXA	AP	Edit

Add SSID

Click on **Add SSID** to create more SSIDs.

Basic WLAN Setup (Multiple SSID)			
Status	SSID	Operation Mode	Action
Active	MOXA	AP	<input type="button" value="Edit"/>
Inactive	<input type="text"/>	AP	<input type="button" value="Save"/> <input type="button" value="Cancel"/>

Click on **Edit** to configure the settings. The RF type, channel, and channel width settings will apply to all SSIDs, all other settings can be configured individually for each SSID. The panel appears as follows:

Basic WLAN Setup	
Operation mode	AP
Indoor/Outdoor	Indoor ▼
WDS	<input checked="" type="checkbox"/> Enable
AP functionality	<input checked="" type="checkbox"/> Enable
RF type	B/G/N Mixed ▼
Channel width	20 MHz ▼
Channel	6 (2437MHz) ▼
SSID	<input type="text" value="MOXA"/>
SSID broadcast	<input checked="" type="radio"/> Enable <input type="radio"/> Disable
Management frame encryption	<input type="radio"/> Enable <input checked="" type="radio"/> Disable
Management frame encryption password	<input type="text"/>
AeroLink AP	<input type="radio"/> Enable <input checked="" type="radio"/> Disable
Client isolation	
Client isolation	No isolation ▼



NOTE

When you switch to **Client, Client-Router, or Slave modes**, a **Site Survey** button will be available on the Basic WLAN Setup panel. Click the "Site Survey" button to view information about available APs, as shown in the following figure. You can click on the SSID of an entity and bring the value of its SSID onto the SSID field of the Basic WLAN Setup page. Click the **Refresh** button to re-scan and update the table.

Basic WLAN Setup

Operation mode Client-Router

RF type B/G/N Mixed ▼

Channel width 20 MHz ▼

SSID Site Survey

Proxy ARP Enable Disable

Site Survey

No.	SSID	MAC Address	Channel	Mode	Signal/Noise Floor
1	MHQ-NB	FC:F5:28:CB:5D:AB	1	BSS/WPA2/Enterprise	<div style="display: flex; justify-content: space-around; width: 100px;"> ■■■■ </div> (-96dBm/-111dBm)
2	MHQ-Mobile	FE:F0:28:CB:5D:AB	1	BSS/WPA2/Enterprise	<div style="display: flex; justify-content: space-around; width: 100px;"> ■■■■ </div> (-96dBm/-111dBm)
3	MHQ-NB	FC:F5:28:CB:5D:93	1	BSS/WPA2/Enterprise	<div style="display: flex; justify-content: space-around; width: 100px;"> ■■■■ </div> (-96dBm/-111dBm)
5	MHQ-Mobile	FE:F0:28:CB:5D:93	1	BSS/WPA2/Enterprise	<div style="display: flex; justify-content: space-around; width: 100px;"> ■■■■ </div> (-97dBm/-111dBm)
6	51_FRED	06:90:E8:00:07:96	1	BSS/WPA2/PSK	<div style="display: flex; justify-content: space-around; width: 100px;"> ■■■■ </div> (-108dBm/-111dBm)
7	MHQ-NB	FC:F5:28:CB:39:02	1	BSS/WPA2/Enterprise	<div style="display: flex; justify-content: space-around; width: 100px;"> ■■■■ </div> (-108dBm/-111dBm)
9	MHQ-Mobile	FE:F0:28:CB:39:02	1	BSS/WPA2/Enterprise	<div style="display: flex; justify-content: space-around; width: 100px;"> ■■■■ </div> (-103dBm/-111dBm)
10	MHQ-NB	FC:F5:28:CB:5D:99	6	BSS/WPA2/Enterprise	<div style="display: flex; justify-content: space-around; width: 100px;"> ■■■■ </div> (-104dBm/-111dBm)
11	MHQ-Mobile	FE:F0:28:CB:5D:99	6	BSS/WPA2/Enterprise	<div style="display: flex; justify-content: space-around; width: 100px;"> ■■■■ </div> (-105dBm/-111dBm)
13	MHQ-NB	FC:F5:28:CB:5D:90	6	BSS/WPA2/Enterprise	<div style="display: flex; justify-content: space-around; width: 100px;"> ■■■■ </div> (-91dBm/-111dBm)
14	MHQ-Mobile	FE:F0:28:CB:5D:90	6	BSS/WPA2/Enterprise	<div style="display: flex; justify-content: space-around; width: 100px;"> ■■■■ </div> (-90dBm/-111dBm)
15	MHQ-NB	FC:F5:28:CB:5D:3F	6	BSS/WPA2/Enterprise	<div style="display: flex; justify-content: space-around; width: 100px;"> ■■■■ </div> (-83dBm/-111dBm)
17	MHQ-Mobile	FE:F0:28:CB:5D:3F	6	BSS/WPA2/Enterprise	<div style="display: flex; justify-content: space-around; width: 100px;"> ■■■■ </div> (-85dBm/-111dBm)
18	MHQ-NB	FC:F5:28:CB:5D:8D	6	BSS/WPA2/Enterprise	<div style="display: flex; justify-content: space-around; width: 100px;"> ■■■■ </div> (-104dBm/-111dBm)

Indoor/outdoor

Setting	Description	Factory Default
Indoor/Outdoor	Select the usage environment, available channels vary depending on the selection	Indoor

WDS (for AP Mode only)

In a WDS (Wireless Distribution System) configuration, a wireless link is established between two IEEE 802.11 APs. Wireless packets transmitted across the WDS link at the link layer and comply with the IEEE 802.11 WDS format. To establish a static WDS bridge link, the APs at both ends of the WDS link must be configured manually with each other's device MAC address. WDS can only be configured in a star or tree topology to prevent loops in the network that may affect performance.

Setting	Description	Factory Default
Enable/Disable	Establish a static wireless link based on the Wireless Distribution System (WDS).	Disable



NOTE

WPA/WPA2 encryption is **not** supported in WDS, only OPEN/WEP security is available. When WDS is enabled, you can create a strictly point-to-point WDS link by disabling AP functionality. The AWK-3131A supports up to 8 WDS links to other APs or wireless bridges. Enter the target device's MAC address to set up a WDS link. If WDS is enabled, a list of bridge connections will appear.

RF type

Setting	Description	Factory Default
2.4 GHz		
B	Only supports the IEEE 802.11b standard	B/G/N Mixed
G	Only supports the IEEE 802.11g standard	
B/G Mixed	Supports IEEE 802.11b/g standards, but 802.11g may operate at a slower speed if when 802.11b clients are on the network	
G/N Mixed	Supports IEEE 802.11g/n standards, but 802.11n may operate at a slower speed if 802.11g clients are on the network	
B/G/N Mixed	Supports IEEE 802.11b/g/n standards, but 802.11g/n may operate at a slower speed if 802.11b clients are on the network	
N Only (2.4 GHz)	Only supports the 2.4 GHz IEEE 802.11n standard	
5 GHz		
A	Only supports the IEEE 802.11a standard	
A/N Mixed	Supports IEEE 802.11a/n standards, but 802.11n may operate at a slower speed if 802.11a clients are on the network	
N Only (5 GHz)	Only supports the 5 GHz IEEE 802.11n standard	

Channel (for AP mode only)

Setting	Description	Factory Default
Available channels vary with RF type	This option is only adjustable when the AWK-3131A plays the role of wireless AP. If the device acts as a wireless client, it follows the channel of the associated access point	6 (in B/G/N Mixed mode)



NOTE

The AWK supports DFS channels in AP mode and will automatically detect interfering radar signals. The AWK will perform a 60-second scan to check for radar signals before starting to use the DFS channel. If a radar signal was detected, the AWK will move to another channel after 10 seconds. The channel with the interfering radar signal will be unavailable for 30 minutes.

Channel width (for any 11N RF type only)

Setting	Description	Factory Default
20 MHz	Select your channel width, If you are not sure which option to use, select 20/ 40 MHz (Auto)	20 MHz
20/40 MHz		

Channel bonding

Channel bonding shows the channel used by the AP if **Channel width** is set to 20/40 MHz

SSID

Setting	Description	Factory Default
Max. of 31 characters	The SSID of a client and the SSID of the AP must be identical for the client and AP to be able to communicate with each other. NOTE: An SSID cannot contain the following characters: ` ' " ; &	MOXA

SSID broadcast (for AP mode only)

Setting	Description	Factory Default
Enable/Disable	Enable or disable SSID broadcast.	Enable



IMPORTANT!

If the **SSID broadcast** function is disabled, APs and clients cannot establish connections on DFS channels. This is because clients are only allowed to do passive scanning of DFS channels; active scanning on these channels is forbidden.

Management Frame Encryption

Setting	Description	Factory Default
Enable/Disable	Enable this function for increased security. Management Frame encryption function allows users to set a specific password for any two devices to connect with each other.	Disable



NOTE

AeroMag does not support Management frame encryption.

AeroLink AP

Setting	Description	Factory Default
Enable/Disable	Enable the AeroLink APs to monitor Ethernet communication on the AP side in order to trigger AeroLink Protection on the client side under milliseconds recovery time. NOTE: AeroLink Protection should be also enabled on the client side at the same time.	Disable

Client Isolation (for AP Mode only)

Client isolation is used to isolate the wireless clients connected to one or more APs. Isolated clients cannot communicate with each other, which increases security. Depending on the type of client isolation, you can specify exceptions (for clients) within the isolation network. This function is useful for cases such as enterprise server services for example.

Setting	Description	Factory Default
No isolation	No isolation is applied.	No isolation
Isolated within the same AP	All clients associated with this AP will be isolated from one another.	
Isolated within the same subnet	All clients in the specified subnet will be isolated from one another. The subnet is defined by the gateway address and subnet mask.	



NOTE

If Client Isolation is enabled, it will be impossible to ping or configure clients directly from the management PC.

AP functionality

Setting	Description	Factory Default
Enable/Disable	Enable this option to allow the AWK-3131A to perform additional AP functions such as connecting standards Wi-Fi clients in addition to acting as a bridge AP.	Disable



NOTE

Both the AP and client devices must be in the same channel and use the same security settings. In addition, an identical SSID is necessary for clients that roam between APs in Bridge mode. The Client will automatically scan for any AP that is using the defined SSID and will establish a bridge link with the matching AP.

WLAN Security Settings

The AWK-3131A provides four standardized wireless security modes: **Open**, **WEP** (Wired Equivalent Privacy), **WPA** (Wi-Fi Protected Access), and **WPA2**. Several security modes are available in the AWK-3131A by selecting **Security mode** and **WPA type**:

- **Open:** No authentication, no data encryption.
- **WEP:** Static WEP (Wired Equivalent Privacy) keys must be configured manually.
- **WPA/WPA2-Personal:** Also known as WPA/WPA2-PSK. You will need to specify the Pre-Shared Key in the Passphrase field, which will be used by the TKIP or AES engine as a master key to generate keys that actually encrypt outgoing packets and decrypt incoming packets.
- **WPA/WPA2-Enterprise:** Also called WPA/WPA2-EAP (Extensible Authentication Protocol). In addition to device-based authentication, WPA/WPA2-Enterprise enables user-based authentication via IEEE 802.1X. The AWK-3131A can support three EAP methods: EAP-TLS, EAP-TTLS, and EAP-PEAP.
- **WPA-WPA2 mixed:** AWK supports WPA/WPA2 at the same time. AWK is able to authenticate with both Wi-Fi clients that use WPA and WPA2.

WLAN Security Settings

SSID: MOXA

Security mode: Open

Submit

Security mode

Setting	Description	Factory Default
Open	No authentication	Open
WEP	Static WEP is used	
WPA*	WPA is used	
WPA2*	Supports IEEE 802.11i with "TKIP/AES + 802.1X"	
WPA-WPA2 mix*	Both WPA and WPA2 clients are able to connect to AWK at the same time	

* This option is not supported when using WDS

Open

For security reasons, you should **NOT** set security mode to Open System, since authentication and data encryption are **NOT** performed in Open System mode.

WEP (only for legacy mode)



NOTE

Moxa includes **WEP** security mode only for legacy purposes. **WEP** is highly insecure and is considered fully deprecated by the Wi-Fi alliance. We do not recommend the use of WEP security under any circumstances.

According to the IEEE 802.11 standard, WEP can be used for authentication and data encryption to maintain confidentiality. Shared (or Shared Key) authentication type is used if WEP authentication and data encryption are both needed. Normally, Open (or Open System) authentication type is used when WEP data encryption is run with authentication.

WLAN Security Settings

SSID MOXA

Security mode WEP ▼

Authentication type Open ▼

Key type HEX ▼

Key length 64 bits ▼

Key index 1 ▼

WEP key 1

WEP key 2

WEP key 3

WEP key 4

When WEP is enabled as a security mode, the length of a key (so-called WEP seed) can be specified as 64/128 bits, which is actually a 40/104-bit secret key with a 24-bit initialization vector. The AWK-3131A provides 4 entities of WEP key settings that can be selected to use with **Key index**. The selected key setting specifies the key to be used as a send-key for encrypting traffic from the AP side to the wireless client side. All 4 WEP keys are used as receive-keys to decrypt traffic from the wireless client side to the AP side.

The WEP key can be presented in two **Key types**, HEX and ASCII. Each ASCII character has 8 bits, so a 40-bit (or 64-bit) WEP key contains 5 characters, and a 104-bit (or 128-bit) key has 13 characters. In hex, each character uses 4 bits, so a 40-bit key has 10 hex characters, and a 128-bit key has 26 characters.

Authentication type

Setting	Description	Factory Default
Open	Data encryption is enabled, but without authentication	Open
Shared	Data encryption and authentication are both enabled	

Key type

Setting	Description	Factory Default
HEX	Specifies WEP keys in hex-decimal number form	HEX
ASCII	Specifies WEP keys in ASCII form	

Key length

Setting	Description	Factory Default
64 bits	Uses 40-bit secret keys with 24-bit initialization vector	64 bits
128 bits	Uses 104-bit secret key with 24-bit initialization vector	

Key index

Setting	Description	Factory Default
1-4	Specifies which WEP key is used	Open

WEP key 1-4

Setting	Description	Factory Default
ASCII type: 64 bits: 5 chars 128 bits: 13chars HEX type: 64 bits: 10 hex chars 128 bits: 26 hex chars	A string that can be used as a WEP seed for the RC4 encryption engine. The key cannot contain the following special characters: ` ' " ; & \$	None

WPA/WPA2-Personal

WPA (Wi-Fi Protected Access) and WPA2 represent significant improvements over the WEP encryption method. WPA is a security standard based on 802.11i draft 3, while WPA2 is based on the fully ratified version of 802.11i. The initial vector is transmitted, encrypted, and enhanced with its 48 bits, twice as long as WEP. The key is regularly changed so that true session is secured.

Even though AES encryption is only included in the WPA2 standard, it is widely available in the WPA security mode of some wireless APs and clients as well. The AWK-3131A also supports AES algorithms in WPA and WPA2 for better compatibility.

Personal versions of WPA/WPA2, also known as WPA/WPA-PSK (Pre-Shared Key), provide a simple way of encrypting a wireless connection for high confidentiality. A **Passphrase** is used as a basis for encryption methods (or cipher types) in a WLAN connection. The passphrases should be complicated and as long as possible. There must be at least 8 ASCII characters in the Passphrase, and it could go up to 63. For security reasons, this passphrase should only be disclosed to users who need it, and it should be changed regularly.

WLAN Security Settings

SSID: MOXA

Security mode: WPA2

WPA type: Personal

Encryption method: AES

EAPOL version: 1

Passphrase: Show Password

Key renewal: 3600 (60~86400 seconds)

WPA type

Setting	Description	Factory Default
Personal	Provides Pre-Shared Key-enabled WPA and WPA2	Personal
Enterprise	Provides enterprise-level security for WPA and WPA2	

Encryption method

Setting	Description	Factory Default
TKIP**	Temporal Key Integrity Protocol is enabled	AES
AES	Advance Encryption System is enabled	
Mixed*	Provides TKIP broadcast key and TKIP+AES unicast key for some legacy AP clients. This option is rarely used.	

** This option is only available with 802.11a/b/g standard

* This option is available for legacy mode in AP/Master only, and does not support AES-enabled clients.

Passphrase

Setting	Description	Factory Default
8 to 63 characters	Master key to generate keys for encryption and decryption. The passphrase cannot contain the following special characters: ` ' " ; & \$ Check Show Password to display the password in clear text.	None

Key renewal (for AP/Master mode only)

Setting	Description	Factory Default
60 to 86400 seconds (1 minute to 1 day)	Specifies the time period of group key renewal	3600 (seconds)



NOTE

The **key renewal** value dictates how often the wireless AP encryption keys should be changed. The security level is generally higher if you set the key renewal value to a shorter number, which forces the encryption keys to be changed more frequently. The default value is 3600 seconds (6 minutes). Longer time periods can be considered if the line is not very busy.

WPA/WPA2-Enterprise (for AP/Master mode)

By setting **WPA type** to **Enterprise**, you can use **EAP** (Extensible Authentication Protocol), a framework authentication protocol used by 802.1X to provide network authentication. In these Enterprise-level security modes, a back-end RADIUS (Remote Authentication Dial-In User Service) server is needed if IEEE 802.1X functionality is enabled in WPA /WPA2. The IEEE 802.1X protocol also offers the possibility of carrying out an efficient connection authentication on a large-scale network. It is not necessary to exchange keys or passphrases.

WLAN Security Settings

SSID MOXA

Security mode WPA ▾

WPA type Enterprise ▾

Encryption method AES ▾

EAPOL version 1 ▾

Primary RADIUS server IP

Primary RADIUS server port 1812

Primary RADIUS shared key

Secondary RADIUS server IP

Secondary RADIUS server port 1812

Secondary RADIUS shared key

Key renewal 3600 (60~86400 seconds)

WPA type

Setting	Description	Factory Default
Personal	Provides Pre-Shared Key-enabled WPA and WPA2	Personal
Enterprise	Provides enterprise-level security for WPA and WPA2	

Encryption method

Setting	Description	Factory Default
TKIP**	Temporal Key Integrity Protocol is enabled	AES
AES	Advance Encryption System is enabled	
Mixed*	Provides TKIP broadcast key and TKIP+AES unicast key for some legacy AP clients. This option is rarely used.	

** This option is only available with 802.11a/b/g standard

* This option is available for legacy mode in AP/Master only, and does not support AES-enabled clients.

Primary/Secondary RADIUS server IP

Setting	Description	Factory Default
The IP address of RADIUS server	Specifies the delegated RADIUS server for EAP	None

Primary/Secondary RADIUS port

Setting	Description	Factory Default
Port number	Specifies the port number of the delegated RADIUS server	1812

Primary/ Secondary RADIUS shared key

Setting	Description	Factory Default
Max. of 31 characters	The secret key shared between AP and RADIUS server The key cannot contain the following special characters: ` ' " ; & \$	None

Key renewal

Setting	Description	Factory Default
60 to 86400 seconds (1 minute to 1 year)	Specifies the time period of group key renewal	3600 (seconds)

WPA/WPA2-Enterprise (for Client/Client-Router/Slave mode)

When used as a client, the AWK-3131A can support three EAP methods (or EAP protocols): EAP-TLS, EAP-TTLS, and EAP-PEAP, corresponding to WPA/WPA-Enterprise settings on the AP side.

WLAN Security Settings

SSID: MOXA

Security mode: WPA2

WPA type: Enterprise

Encryption method: TKIP

EAPOL version: 1

EAP protocol: TLS

Certificate issued to: [blank]

Certificate issued by: [blank]

Certificate expiration date: [blank]

Submit

Encryption method

Setting	Description	Factory Default
TKIP**	Temporal Key Integrity Protocol is enabled	TKIP
AES	Advance Encryption System is enabled	

**This option is only available with 802.11a/b/g standard.

EAP protocol

Setting	Description	Factory Default
TLS	Specifies Transport Layer Security protocol	TLS
TTLS	Specifies Tunneled Transport Layer Security	
PEAP	Specifies Protected Extensible Authentication Protocol, or Protected EAP	

Before choosing the EAP protocol for your WPA/WPA2-Enterprise settings on the client end, please contact the network administrator to make sure the system supports the protocol on the AP end. Detailed information on these three popular EAP protocols is presented in the following sections.

EAP-TLS

TLS is the standards-based successor to Secure Socket Layer (SSL). It can establish a trusted communication channel over a distrusted network. TLS provides mutual authentication through certificate exchange. EAP-TLS is also secure to use. You are required to submit a digital certificate to the authentication server for validation, but the authentication server must also supply a certificate.

You can use **Basic WLAN Setup > WLAN Certificate Settings** to import your WLAN certificate and enable EAP-TLS on the client end.

WLAN Security Settings

SSID	MOXA
Security mode	WPA2 ▼
WPA type	Enterprise ▼
Encryption method	TKIP ▼
EAPOL version	1 ▼
EAP protocol	TLS ▼
Certificate issued to	
Certificate issued by	
Certificate expiration date	

You can check the current certificate status in **Current Status** if it is available.

- **Certificate issued to:** Shows the certificate user
- **Certificate issued by:** Shows the certificate issuer
- **Certificate expiration date:** Indicates when the certificate has expired

EAP-TTLS

It is usually much easier to re-use existing authentication systems, such as a Windows domain or Active Directory, LDAP directory, or Kerberos realm, rather than creating a parallel authentication system. As a result, TTLS (Tunneled TLS) and PEAP (Protected EAP) are used to support the use of so-called "legacy authentication methods."

TTLS and PEAP work in a similar way. First, they establish a TLS tunnel (EAP-TLS for example), and validate whether the network is trustworthy with digital certificates on the authentication server. This step establishes a tunnel that protects the next step (or "inner" authentication), and consequently is sometimes referred to as "outer" authentication. The TLS tunnel is then used to encrypt an older authentication protocol that authenticates the user for the network.

As you can see, digital certificates are still needed for outer authentication in a simplified form. Only a small number of certificates are required, which can be generated by a small certificate authority. Certificate reduction makes TTLS and PEAP much more popular than EAP-TLS.

The AWK-3131A provides some non-cryptographic EAP methods, including **PAP**, **CHAP**, **MS-CHAP**, and **MS-CHAP-V2**. These EAP methods are not recommended for direct use on wireless networks. However, they may be useful as inner authentication methods with TTLS and PEAP.

Because the inner and outer authentications can use distinct user names in TTLS and PEAP, you can use an anonymous user name for the outer authentication, with the true user name only shown through the encrypted channel. Keep in mind that not all client software supports anonymous alteration. Confirm this with the network administrator before you enable identity hiding in TTLS and PEAP.

WLAN Security Settings

SSID MOXA

Security mode WPA2 ▼

WPA type Enterprise ▼

Encryption method TKIP ▼

EAPOL version 1 ▼

EAP protocol TTLS ▼

TTLS inner authentication MS-CHAP-V2 ▼

Anonymous name

User name

Password

TTLS inner authentication

Setting	Description	Factory Default
PAP	Password Authentication Protocol is used	MS-CHAP-V2
CHAP	Challenge Handshake Authentication Protocol is used	
MS-CHAP	Microsoft CHAP is used	
MS-CHAP-V2	Microsoft CHAP version 2 is used	

Anonymous

Setting	Description	Factory Default
Max. of 31 characters	A distinct name used for outer authentication	None

User name & Password

Setting	Description	Factory Default
-	User name and password used in inner authentication which cannot contain the following the special characters: ` ' " ; & \$	None

PEAP

There are a few differences in the TTLS and PEAP inner authentication procedures. TTLS uses the encrypted channel to exchange attribute-value pairs (AVPs), while PEAP uses the encrypted channel to start a second EAP exchange inside of the tunnel. The AWK-3131A provides **MS-CHAP-V2** merely as an EAP method for inner authentication.

WLAN Security Settings

SSID MOXA

Security mode WPA2 ▼

WPA type Enterprise ▼

Encryption method TKIP ▼

EAPOL version 1 ▼

EAP protocol PEAP ▼

Inner EAP protocol MS-CHAP-V2 ▼

Anonymous name MS-CHAP-V2

User name

Password

Inner EAP protocol

Setting	Description	Factory Default
MS-CHAP-V2	Microsoft CHAP version 2 is used	MS-CHAP-V2

Anonymous

Setting	Description	Factory Default
Max. of 31 characters	A distinct name used for outer authentication	None

User name & Password

Setting	Description	Factory Default
-	User name and password used for authentication which cannot contain the following the special characters: ` ' " ; & \$	None

Advanced WLAN Settings

Additional wireless-related parameters are presented in this section to help you set up your wireless network in detail.

Advanced WLAN Settings

Transmission rate	Auto ▾
Minimum transmission rate	0 (0~11Mbps, 0 to disable)
Multicast rate	11M ▾
Maximum transmission power	18 dBm ▾
Beacon interval	100 (40 to 1000 ms)
DTIM interval	1 (1 to 15)
Inactive timeout	60 (8 to 240 second)
Fragmentation threshold	2346 (256 to 2346)
RTS threshold	2346 (32 to 2346)
Antenna	Both ▾
	<ul style="list-style-type: none"> Regarding Wi-Fi performance, we recommend you to use two antennas to ensure high throughput.
WMM	Enable ▾
AP-based disconnection	<input type="checkbox"/> Enable
Wireless link health check	<input checked="" type="checkbox"/> Enable
Threshold	<input checked="" type="radio"/> SNR 14 dB (5 to 60) <input type="radio"/> Signal Strength -90 dBm (-100 to -35)
Count	3 (1 to 5)
Timeout	150 ms (10 to 1000)
Interval	100 ms (50 to 1000)

Transmission rate

Setting	Description	Factory Default
Auto	The AWK-3131A senses and adjusts the data rate automatically	
Available rates	Users can manually select a target transmission data rate but does not support when RF type are G/N mixed, B/G/N mixed and A/N mixed.	Auto

Minimum transmission rate

Setting	Description	Factory Default
0 to 64 Mbps (0 to disable)	By setting a minimum transmission rate, the AWK-3131A will avoid communicate with weak signal wireless links to maintain overall wireless performance and optimize the wireless frequency usage.	0 (Disable)

Multicast rate

Setting	Description	Factory Default
Available rates	You can set a fixed multicast rate for the transmission of broadcast and multicast packets on a per-radio basis. This parameter can be useful in an environment where multicast video streaming is occurring in the wireless medium, providing the wireless clients are capable of handling the configured rate	6M

Maximum Transmission power

Setting	Description	Factory Default
Available power	Users can manually select a target power to mask max output power. Because different transmission rates would have their own max output power, please reference product datasheet. For 802.11bg, the available setting is from 0 to 20	20 dBm

Beacon interval (for AP/Master mode only)

Setting	Description	Factory Default
Beacon Interval (40 to 1000 ms)	Indicates the frequency interval of the beacon	100 (ms)

Inactive timeout (for AP mode only)

Setting	Description	Factory Default
8 to 240 seconds	Specifies how long before access point starts sending out client alive packets	60 seconds

DTIM interval (for AP/Master mode only)

Setting	Description	Factory Default
Data Beacon Rate (1 to 15)	Indicates how often the AWK-3131A sends out a Delivery Traffic Indication Message	1

Fragmentation threshold

Setting	Description	Factory Default
Fragment Length (256 to 2346)	Specifies the maximum size a data packet before splitting and creating another new packet	2346

RTS threshold

Setting	Description	Factory Default
RTS/CTS Threshold (256 to 2346)	Determines how large a packet can be before the Access Point coordinates transmission and reception to ensure efficient communication	2346

**NOTE**

You can refer to the related glossaries in Appendix A for detailed information about the above-mentioned settings. By setting these parameters properly, you can better tune the performance of your wireless network.

Transmission distance

Setting	Description	Factory Default
Distance or max. range for transmission (500 to 11,000 m)	Specifies the transmission distance or max. range between two AWK devices. This parameter should be set properly, especially for long-distance communication.	500

**NOTE**

Make sure the same **Transmission distance** parameters are set in both **AP** and **Client**. When this parameter is greater than 500, an optimal algorithm will be enabled (only in the 5 GHz channel) to support long-distance transmission.

Antenna

Setting	Description	Factory Default
A/B/Auto	Specifies the output antenna port. Setting "Antenna" to Auto allows 2x2 MIMO communication under 802.11n and 2T2R* communication in legacy 802.11a/b/g modes.	Auto

*Different from 802.11n's multiple spatial data stream (2x2 MIMO), which doubles the throughput, 2T2R transmits/receives the same piece of data on both antenna ports.

WMM

Setting	Description	Factory Default
Enable/Disable	WMM is a QoS standard for WLAN traffic. Voice and video data will be given priority bandwidth when enabled with WMM supported wireless clients. NOTE: WMM will always be enabled under 802.11n mode.	Enable

AP-based disconnection

Setting	Description	Factory Default
Enable/Disable	Enable or disable AP-based disconnection. This feature aims to make sure the client is always associated to the AP with the best SNR/signal strength. The associated client will be forced to connect to another AP when the SNR/Signal strength drops below the configured threshold during the specified monitoring period.	Disable

When AP-based disconnection is enabled, the following parameters will be shown:

- **Threshold:** Specify either the signal-to-noise (SNR) or signal strength threshold to determine when clients will roam to another AP once the respective value drops below the set threshold.
- **Client-signal monitor time:** Specify the duration of the signal check (in seconds). The default is 3 seconds.

Wireless link health check

Setting	Description	Factory Default
Enable/Disable	Enable or disable wireless link health check. When enabled, this feature will help detect and recover unstable connections.	Disable

When Wireless link health check is enabled, the following parameters will be shown:

- **Threshold:** Specify either the signal-to-noise (SNR) or signal strength threshold to determine when the AP will perform a health check on the wireless client connections.
- **Count:** Specify the number of ping packets that will be sent in a check.
- **Timeout:** Specify the duration (in ms) of receiving no response before the check times out.
- **Interval:** Specify the ping interval (in ms).

Turbo Roaming (for Client/Client-router/Slave Mode only)

Setting	Description	Factory Default
Enable/ Disable	Moxa's Turbo Roaming can enable rapid handover when the AWK-3131A, as a client, roams among a group of APs.	Disable

When Turbo Roaming is enabled, the following parameters will be shown:

- **Roaming threshold:** Determines when to start looking for new AP candidates. If the current connection quality (SNR or Signal Strength) is lower than the specified threshold, the AWK will start background scanning and look for next-hop candidates.

The following table lists the default threshold values for different RF types:

RF Type	RSSI	Signal Strength
Legacy 2.4G	30	-65
Legacy 5G	30	-65
N-mode 2.4G	40	-55
N-mode 5G	40	-50



NOTE

While the AWK is scanning the background, its wireless performance will be reduced by 1/3 of its normal performance.

- **Roaming difference:** Determines if roaming should be executed. After background scan has been triggered, the roaming will only occur if the AP candidate(s) provide a better (Roaming difference) connection quality than the current connection. If multiple access points fulfill the criteria, the AWK will pick the best one to roam to.
- **Scan channels:** This function is used to check the usable channels for roaming. Select All to check all channels or select Partial to check up to 11 pre-defined communication and roaming channels.



NOTE

If AeroMag client is enabled, there will only be three scan channels which are assigned by AeroMag automatically.

The more channels are configured, the longer the scan will take to complete. This may increase the risk of disconnection if applied to fast moving clients. In high-density client environments, it may also cause performance drops.

- **AP alive check:** Allows Turbo Roaming to react faster to WLAN disconnections.



NOTE

Enabling this feature causes the AWK-3131A to send out alive check packets every 10 ms when there is no traffic; the high transmission frequency of small alive check packets could potentially affect your other wireless communications that use the same channel, so only enable this feature when you have full control of the designated radio channel.

- **AP candidate threshold:** After the “AP alive check” declares the current access point is no longer available, the surrounding access points must have good enough connection qualities (SNR/Signal Strength) in order to qualify as AP candidates for client association.

Turbo Roaming	<input checked="" type="checkbox"/> Enable
RF type	B/G/N Mixed
Roaming threshold	<input checked="" type="radio"/> SNR <input type="text" value="40"/> dB (5 to 60) <input type="radio"/> Signal Strength <input type="text" value="-55"/> dBm (-100 to -35)
Roaming difference	<input type="text" value="7"/> (5 to 20)
Scan channels	<input type="text" value="6 (2437MHz)"/> ▾ <input type="text" value="Not Scanning"/> ▾ <input type="text" value="Not Scanning"/> ▾ <input type="text" value="Not Scanning"/> ▾ <input type="text" value="Not Scanning"/> ▾ <input type="text" value="Not Scanning"/> ▾ <input type="text" value="Not Scanning"/> ▾ <input type="text" value="Not Scanning"/> ▾ <input type="text" value="Not Scanning"/> ▾ <input type="text" value="Not Scanning"/> ▾ <input type="text" value="Not Scanning"/> ▾ <input type="text" value="Not Scanning"/> ▾
AP alive check	<input type="text" value="Disable"/> ▾



NOTE

The Turbo Roaming recovery time (<150 ms) listed in the product documentation is an average of test results documented, in optimized conditions, across APs configured with interference-free 20-MHz RF channels, WPA2-PSK security, and default Turbo Roaming parameters. The clients are configured with 3-channel roaming at 100 Kbps traffic load. However, a combination of factors affect the AP handover recovery time of a roaming client, including but not limited to the following:

- On-site RF interference
- Velocity of the moving client devices
- Application traffic throughput
- Turbo Roaming parameters configured. i.e., Roaming threshold, Roaming difference, and AP candidate threshold.

Therefore, a site survey prior to device deployment is recommended to evaluate the ideal parameter settings on both clients and APs so that you can come up with an optimal deployment plan for your applications.

AeroLink Protection (for Client/Slave mode only)

Setting	Description	Factory Default
Enable/Disable	Enable AeroLink Protection to allow wireless clients on the same LAN network to automatically negotiate with each other and form a redundant wireless communication. , for more details, see Status → AeroLink Protection Status	Disable

When **AeroLink Protection** is enabled, the following parameters will be shown:

AeroLink Protection	<input type="text" value="Enable"/> ▾
AP alive check	<input type="text" value="Disable"/> ▾
AeroLink SNR/Signal Strength detection	<input checked="" type="checkbox"/> Enable
AeroLink threshold	<input checked="" type="radio"/> SNR <input type="text" value="40"/> (5 to 40) <input type="radio"/> Signal Strength <input type="text" value="-55"/> dBm (-100 to -35)
AeroLink difference	<input type="text" value="7"/> (5 to 20)

- **AP alive check:** Select **Enable** to allow AeroLink Protection to react faster to WLAN disconnections
- **AeroLink SNR/Signal Strength detection:** Allows AeroLink to react based on SNR/Signal Strength threshold values
- **AeroLink threshold:** Determines when to start looking for redundant wireless devices. If the current connection quality (SNR or Signal Strength) is lower than the specified threshold, clients will start looking for other suitable wireless devices.
- **AeroLink difference:** Determines when clients should switch to another communication path. After looking for redundant wireless devices has been triggered, switching to redundant wireless devices will only occur if the candidate provides a better (AeroLink difference) connection quality than the current connection.



NOTE

Enabling the AeroLink feature causes the AWK-3131A to send out alive-check packets every 10 ms when there is no traffic. The high transmission frequency of these alive-check packets could potentially affect other wireless communications that use the same channel. So, only enable this feature when you have full control of the designated radio channel.

MAC clone (for Client mode only)

MAC clone	Enable ▼
MAC clone method	Static ▼
MAC clone static MAC	<input type="text"/> (ex: 00:90:E8:00:00:01)

Setting	Description	Factory Default
MAC clone	Enabling this feature allows the AWK client to copy the MAC address of the equipment connected to the LAN. This overcomes the limitation of the IP-Bridged behavior in a MAC-sensitive network (MAC-based communication or MAC-authenticated network).	Disable
MAC clone method	<ul style="list-style-type: none"> • Auto: The AWK client copies the MAC address of the device connected to the LAN if only one device connects to AWK. • Static: The AWK client shares the assigned MAC address with multiple devices connected to the LAN. This allows for multiple devices to connect to the AWK via the LAN and only one of them needs to be assigned a MAC address. 	Auto
MAC clone static address	Specifies the static MAC address that the connected AWK devices should copy.	–



NOTE

Auto MAC Cloning cannot be used together with Link Fault Pass Through.

Remote connection check (for Client/Client-router/Slave mode only)

Setting	Description	Factory Default
Enable/Disable	Enable remote connection check to automatically check the status of the connection and re-establish the connection when a connection failure occurs	Disable

When Remote connection check is enabled, the following parameters will be shown:

Remote connection check	<input checked="" type="checkbox"/> Enable
Re-establish WLAN connection	<input checked="" type="checkbox"/> Enable
Device reboot	<input type="checkbox"/> Enable
Remote host	<input type="text"/> (ex: 192.168.127.253)
Check interval	<input type="text" value="10"/> (1 to 30 seconds)
Timeout	<input type="text" value="1000"/> (100 to 10000 ms)
Retry count	<input type="text" value="3"/> (1 to 5)
Retry interval	<input type="text" value="1"/> (1 to 30 seconds)
Reboot count	<input type="text" value="3"/> (0 to 5)

- **Re-establish WLAN connection:** Re-establish the WLAN connection in the event a connection failure.
- **Device reboot:** Reboot the device in the event of a connection failure.



NOTE

If **Re-establish WLAN connection** and **Device reboot** are both enabled, the AWK-3131A will attempt to restore the WLAN connection first. If re-establishing the WLAN connection fails, the device will reboot.

- **Remote host:** Enter the IP address of a remote host to ping. This is used for the WLAN connection alive and packet-level connection checks.
- **Check interval:** Specify the time interval when the AWK-3131A checks the connection. The range is between 1 to 30 seconds, the default is every 10 seconds.
- **Timeout:** Specify the duration the AWK-3131A must wait before terminating the connection. The range is between 100 to 10,000 ms, the default is 1000 ms.
- **Retry count:** Specify the number of times the AWK-3131A will check the connection status. If the connection fails more than the specified number of tries, the device will attempt to recover the WLAN connection. The range is between 1 to 5, the default is 3 retries.
- **Retry Interval:** Specify the time interval in between each retry. The range is between 1 to 30 seconds, the default is 1 second.
- **Reboot count:** If **Device reboot** is enabled, specify the number of times the device will reboot after failing to re-establish the connection.

WLAN Certificate Settings (for EAP-TLS in Client/Client-router/Slave mode only)

When EAP-TLS is used, a WLAN Certificate will be required at the client end to support WPA/WPA2-Enterprise. The AWK-3131A can support the **PKCS #12**, also known as Personal Information Exchange Syntax Standard, certificate formats that define file formats commonly used to store private keys with accompanying public key certificates, protected with a password-based symmetric key.

WLAN Certificate Settings	
Certificate private password	<input type="text"/>
Select certificate/key file	<input type="button" value="Browse..."/>
<input type="button" value="Submit"/>	
Status	
Certificate issued to	
Certificate issued by	
Certificate expiration date	

Current status displays information for the current WLAN certificate, which has been imported into the AWK-3131A. Nothing will be shown if a certificate is not available.

- **Certificate issued to:** Shows the certificate user
- **Certificate issued by:** Shows the certificate issuer
- **Certificate expiration date:** Indicates when the certificate has expired

You can import a new WLAN certificate in **Import WLAN Certificate** by following these steps, in order:

1. Input the corresponding password (or key) in the **Certificate private password** field and then click **Submit** to set the password.
2. The password will be displayed in the Certificate private password field. Click on the **Browse** button in **Select certificate/key file** and select the certificate file.
3. Click **Upload Certificate File** to import the certificate file. If the import succeeds, you can see the information uploaded in **Current Certificate**. If it fails, you may need to return to step 1 to set the password correctly and then import the certificate file again.

Step 1:

Certificate private password

Step 2:

Select certificate/key file



NOTE

The WLAN certificate will remain after the AWK-3131A reboots. Even though it is expired, it can still be seen on the **Current Certificate**.

Advanced Setup

Several advanced functions are available to increase the functionality of your AWK-3131A and wireless network system. A VLAN is a collection of clients and hosts grouped together as if they were connected to the broadcast domains in a Layer-2 network. The DHCP server helps you deploy wireless clients efficiently. Packet filters provide security mechanisms, such as firewalls, in different network layers. Moreover, the AWK-3131A can support STP/RSTP protocol to increase reliability across the entire network, and SNMP support can make network management easier.

Using Virtual LAN

Setting up Virtual LANs (VLANs) on your AWK series increases the efficiency of your network by dividing the LAN into logical segments, as opposed to physical segments. In general, VLANs are easier to manage.

The Virtual LAN (VLAN) Concept

What is a VLAN?

A virtual LAN, commonly known as a VLAN, is a group of hosts with a common set of requirements that communicate as if they were attached to the same broadcast domain, regardless of their physical location. A VLAN has the same attributes as a physical LAN, but it allows for end stations to be grouped together even if they are not located on the same network switch. Network reconfiguration can be done through software instead of physically relocating devices.

VLANs now extend as far as the reach of the access point signal. Clients can be segmented into wireless sub-networks via SSID and VLAN assignment. A Client can access the network by connecting to an AP configured to support its assigned SSID/VLAN.

Benefits of VLANs

VLANs are used to conveniently, efficiently, and easily manage your network in the following ways:

- Manage adds, moves, and changes from a single point of contact
- Define and monitor groups
- Reduce broadcast and multicast traffic to unnecessary destinations
- Improve network performance and reduce latency
- Increase security
- Secure network restricts members to resources on their own VLAN
- Clients roam without compromising security

VLAN Workgroups and Traffic Management

The AP assigns clients to a VLAN based on a Network Name (SSID). The AP can support up to 9 SSIDs per radio interface, with a unique VLAN configurable per SSID.

The AP matches packets transmitted or received to a network name with the associated VLAN. Traffic received by a VLAN is only sent on the wireless interface associated with that same VLAN. This eliminates unnecessary traffic on the wireless LAN, conserving bandwidth and maximizing throughput.

In addition to enhancing wireless traffic management, the VLAN-capable AP supports easy assignment of wireless users to workgroups. In a typical scenario, each user VLAN represents a department workgroup; for example, one VLAN could be used for a marketing department and the other for a human resource department.

In this scenario, the AP would assign every packet it accepted to a VLAN. Each packet would then be identified as marketing or human resource, depending on which wireless client received it. The AP would insert VLAN headers or "tags" with identifiers into the packets transmitted on the wired backbone to a network switch.

Finally, the switch would be configured to route packets from the marketing department to the appropriate corporate resources such as printers and servers. Packets from the human resource department could be restricted to a gateway that allowed access to only the Internet. A member of the human resource department could send and receive e-mail and access the Internet, but would be prevented from accessing servers or hosts on the local corporate network.

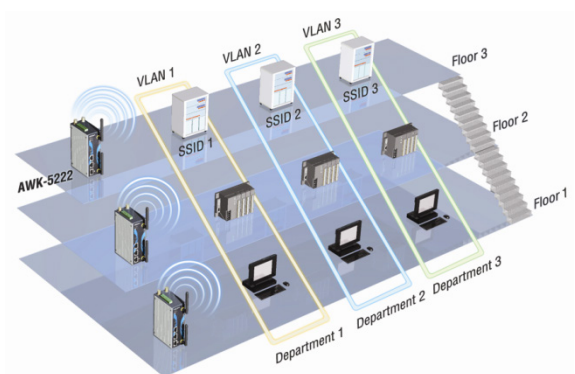

Configuring Virtual LAN

VLAN Settings

To configure the AWK's VLAN, use the VLAN Setting page to configure the ports.

Port	PVID	VLAN Tagged (Use commas to separate VLAN tags)
LAN	1	
MOXA (WLAN 1)	1	

Management VLAN ID

Setting	Description	Factory Default
VLAN ID ranges from 1 to 4094	Set the management VLAN of this AWK.	1

Port

Type	Description	Trunk Port
LAN	This port is the LAN port on the AWK.	Yes
WLAN	This is a wireless port for the specific SSID. This field will refer to the SSID that you have created. If more SSIDs have been created, new rows will be added.	

Port PVID

Setting	Description	Factory Default
VLAN ID ranging from 1 to 4094	Set the port's VLAN ID for devices that connect to the port. The port can be a LAN port or WLAN ports.	1

VLAN Tagged

Setting	Description	Factory Default
A comma-separated list of VLAN IDs. Each of the VLAN IDs range from 1 to 4094.	Specify which VLANs can communicate with this specific VLAN.	(Empty)



NOTE

The VLAN feature can allow wireless clients to manage the AP. If the VLAN Management ID matches a VLAN ID, then those wireless clients who are members of that VLAN will have AP management access.

CAUTION: Once a VLAN Management ID is configured and is equivalent to one of the VLAN IDs on the AP, all members of that User VLAN will have management access to the AP. Be careful to restrict VLAN membership to those with legitimate access to the AP.

DHCP Server (for AP/Client-router mode only)

DHCP (Dynamic Host Configuration Protocol) is a networking protocol that allows administrators to assign temporary IP addresses to network computers by "leasing" an IP address to a user for a limited amount of time, instead of assigning permanent IP addresses.

The AWK-3131A can act as a simplified DHCP server and easily assign IP addresses to your DHCP clients by responding to the DHCP requests from the client ends. The IP-related parameters you set on this page will also be sent to the client.

You can also assign a static IP address to a specific client by entering its MAC address. The AWK-3131A provides a **Static DHCP mapping** list with up to 16 entities. Be reminded to check the **Active** check box for each entity to activate the setting.

You can check the IP assignment status under **Status > DHCP Client List**.

DHCP Server (For AP/Client-Router mode only)

DHCP server

Default gateway

Subnet mask

Primary DNS server

Secondary DNS server

Starting IP address

Maximum number of users

Client lease time (2 to 14400 minutes)

Static DHCP Mapping

No.	<input type="checkbox"/> Active	IP Address	MAC Address
1	<input type="checkbox"/>	<input type="text"/>	<input type="text"/>
2	<input type="checkbox"/>	<input type="text"/>	<input type="text"/>
3	<input type="checkbox"/>	<input type="text"/>	<input type="text"/>
4	<input type="checkbox"/>	<input type="text"/>	<input type="text"/>
5	<input type="checkbox"/>	<input type="text"/>	<input type="text"/>
6	<input type="checkbox"/>	<input type="text"/>	<input type="text"/>
7	<input type="checkbox"/>	<input type="text"/>	<input type="text"/>
8	<input type="checkbox"/>	<input type="text"/>	<input type="text"/>
9	<input type="checkbox"/>	<input type="text"/>	<input type="text"/>
10	<input type="checkbox"/>	<input type="text"/>	<input type="text"/>
11	<input type="checkbox"/>	<input type="text"/>	<input type="text"/>
12	<input type="checkbox"/>	<input type="text"/>	<input type="text"/>
13	<input type="checkbox"/>	<input type="text"/>	<input type="text"/>
14	<input type="checkbox"/>	<input type="text"/>	<input type="text"/>
15	<input type="checkbox"/>	<input type="text"/>	<input type="text"/>
16	<input type="checkbox"/>	<input type="text"/>	<input type="text"/>

DHCP server

Setting	Description	Factory Default
Enable	Enables AWK-3131A as a DHCP server	Disable
Disable	Disable DHCP server function	

Default gateway

Setting	Description	Factory Default
IP address of a default gateway	The IP address of the router that connects to an outside network	None

Subnet mask

Setting	Description	Factory Default
subnet mask	Identifies the type of sub-network (e.g., 255.255.0.0 for a Class B network, or 255.255.255.0 for a Class C network)	None

Primary/ Secondary DNS server

Setting	Description	Factory Default
IP address of Primary/ Secondary DNS server	The IP address of the DNS Server used by your network. After entering the DNS Server's IP address, you can use URL as well. The Secondary DNS server will be used if the Primary DNS server fails to connect.	None

Start IP address

Setting	Description	Factory Default
IP address	Indicates the IP address which AWK-3131A can start assigning	None

Maximum number of users

Setting	Description	Factory Default
1 to 128	Specifies how many IP address can be assigned continuously	None

Client lease time

Setting	Description	Factory Default
2 to 14400 minutes	The lease time for which an IP address is assigned. The IP address may go expired after the lease time is reached.	14400 minutes (10 days)

Packet Filters

The AWK-3131A includes various filters for **IP-based** packets going through LAN and WLAN interfaces. You can set these filters as a firewall to help enhance network security.

MAC Filters

The AWK-3131A's MAC filter is a policy-based filter that can allow or filter out IP-based packets with specified MAC addresses. The AWK-3131A provides 60 entities for setting MAC addresses in your filtering policy. Remember to check the **Active** check box for each entity to activate the setting.

MAC Filters

MAC filters function Disable ▼

Policy Drop ▼

No.	<input type="checkbox"/> Active	Name	MAC Address
1	<input type="checkbox"/>		
2	<input type="checkbox"/>		
3	<input type="checkbox"/>		
4	<input type="checkbox"/>		
5	<input type="checkbox"/>		
6	<input type="checkbox"/>		
7	<input type="checkbox"/>		
8	<input type="checkbox"/>		
9	<input type="checkbox"/>		
10	<input type="checkbox"/>		
.			
.			
50	<input type="checkbox"/>		
51	<input type="checkbox"/>		
52	<input type="checkbox"/>		
53	<input type="checkbox"/>		
54	<input type="checkbox"/>		
55	<input type="checkbox"/>		
56	<input type="checkbox"/>		
57	<input type="checkbox"/>		
58	<input type="checkbox"/>		
59	<input type="checkbox"/>		
60	<input type="checkbox"/>		

MAC filters

Setting	Description	Factory Default
Enable	Enables MAC filters	Disable
Disable	Disables MAC filters	

Policy

Setting	Description	Factory Default
Accept	Only the packets fitting the entities on list can be allowed.	Accept
Drop	Any packet fitting the entities on list will be denied.	



ATTENTION

Be careful when you enable the filter function:

Drop + "no entity on list is activated" = all packets are **allowed**

Accept + "no entity on list is activated" = all packets are **denied**

IP Protocol Filters

The AWK-3131A's IP protocol filter is a policy-based filter that can allow or filter out IP-based packets with specified IP protocol and source/destination IP addresses.

The AWK-3131A provides 60 entities for setting IP protocol and source/destination IP addresses in your filtering policy. Four IP protocols are available: **All**, **ICMP**, **TCP**, and **UDP**. You must specify either the Source IP or the Destination IP. By combining IP addresses and netmasks, you can specify a single IP address or a range of IP addresses to accept or drop. For example, "IP address 192.168.1.1 and netmask 255.255.255.255" refers to the sole IP address 192.168.1.1. "IP address 192.168.1.1 and netmask 255.255.255.0" refers to the range of IP addresses from 192.168.1.1 to 192.168.255. Remember to check the **Active** check box for each entity to activate the setting.

IP Protocol Filters

IP protocol filters function: Disable ▾

Policy: Drop ▾

No.	<input type="checkbox"/> Active	Protocol	Source IP	Source Netmask	Destination IP	Destination Netmask
1	<input type="checkbox"/>	All ▾				
2	<input type="checkbox"/>	All ▾				
3	<input type="checkbox"/>	All ▾				
4	<input type="checkbox"/>	All ▾				
5	<input type="checkbox"/>	All ▾				
6	<input type="checkbox"/>	All ▾				
7	<input type="checkbox"/>	All ▾				
8	<input type="checkbox"/>	All ▾				
9	<input type="checkbox"/>	All ▾				
10	<input type="checkbox"/>	All ▾				
⋮						
50	<input type="checkbox"/>	All ▾				
51	<input type="checkbox"/>	All ▾				
52	<input type="checkbox"/>	All ▾				
53	<input type="checkbox"/>	All ▾				
54	<input type="checkbox"/>	All ▾				
55	<input type="checkbox"/>	All ▾				
56	<input type="checkbox"/>	All ▾				
57	<input type="checkbox"/>	All ▾				
58	<input type="checkbox"/>	All ▾				
59	<input type="checkbox"/>	All ▾				
60	<input type="checkbox"/>	All ▾				

Submit

IP protocol filters

Setting	Description	Factory Default
Enable	Enables IP protocol filters	Disable
Disable	Disables IP protocol filters	

Policy

Setting	Description	Factory Default
Accept	Only the packets fitting the entities on the list can be allowed	Accept
Drop	Any packet fitting the entities on the list will be denied	



ATTENTION

Be careful when you enable the filter function:

Drop + "no entity on list is activated" = all packets are **allowed**

Accept + "no entity on list is activated" = all packets are **denied**

TCP/UDP Port Filters

The AWK-3131A's TCP/UDP port filter is a policy-based filter that can allow or filter out TCP/UDP-based packets with a specified source or destination port.

The AWK-3131A provides 60 entities for setting the range of source/destination ports of a specific protocol. In addition to selecting TCP or UDP protocol, you can set either the source port, destination port, or both. The end port can be left empty if only a single port is specified. Of course, the end port cannot be larger than the start port.

The **Application name** is a text string that describes the corresponding entity with up to 31 characters. Remember to check the **Active** check box for each entity to activate the setting.

TCP/UDP Port Filters

TCP/UDP port filters function Disable ▼

Policy Drop ▼

No.	<input type="checkbox"/> Active	Source Port	Destination Port	Protocol	Application Name
1	<input type="checkbox"/>	<input type="text"/> ~ <input type="text"/>	<input type="text"/> ~ <input type="text"/>	TCP ▼	<input type="text"/>
2	<input type="checkbox"/>	<input type="text"/> ~ <input type="text"/>	<input type="text"/> ~ <input type="text"/>	TCP ▼	<input type="text"/>
3	<input type="checkbox"/>	<input type="text"/> ~ <input type="text"/>	<input type="text"/> ~ <input type="text"/>	TCP ▼	<input type="text"/>
4	<input type="checkbox"/>	<input type="text"/> ~ <input type="text"/>	<input type="text"/> ~ <input type="text"/>	TCP ▼	<input type="text"/>
5	<input type="checkbox"/>	<input type="text"/> ~ <input type="text"/>	<input type="text"/> ~ <input type="text"/>	TCP ▼	<input type="text"/>
6	<input type="checkbox"/>	<input type="text"/> ~ <input type="text"/>	<input type="text"/> ~ <input type="text"/>	TCP ▼	<input type="text"/>
7	<input type="checkbox"/>	<input type="text"/> ~ <input type="text"/>	<input type="text"/> ~ <input type="text"/>	TCP ▼	<input type="text"/>
8	<input type="checkbox"/>	<input type="text"/> ~ <input type="text"/>	<input type="text"/> ~ <input type="text"/>	TCP ▼	<input type="text"/>
9	<input type="checkbox"/>	<input type="text"/> ~ <input type="text"/>	<input type="text"/> ~ <input type="text"/>	TCP ▼	<input type="text"/>
10	<input type="checkbox"/>	<input type="text"/> ~ <input type="text"/>	<input type="text"/> ~ <input type="text"/>	TCP ▼	<input type="text"/>
.					
.					
50	<input type="checkbox"/>	<input type="text"/> ~ <input type="text"/>	<input type="text"/> ~ <input type="text"/>	TCP ▼	<input type="text"/>
51	<input type="checkbox"/>	<input type="text"/> ~ <input type="text"/>	<input type="text"/> ~ <input type="text"/>	TCP ▼	<input type="text"/>
52	<input type="checkbox"/>	<input type="text"/> ~ <input type="text"/>	<input type="text"/> ~ <input type="text"/>	TCP ▼	<input type="text"/>
53	<input type="checkbox"/>	<input type="text"/> ~ <input type="text"/>	<input type="text"/> ~ <input type="text"/>	TCP ▼	<input type="text"/>
54	<input type="checkbox"/>	<input type="text"/> ~ <input type="text"/>	<input type="text"/> ~ <input type="text"/>	TCP ▼	<input type="text"/>
55	<input type="checkbox"/>	<input type="text"/> ~ <input type="text"/>	<input type="text"/> ~ <input type="text"/>	TCP ▼	<input type="text"/>
56	<input type="checkbox"/>	<input type="text"/> ~ <input type="text"/>	<input type="text"/> ~ <input type="text"/>	TCP ▼	<input type="text"/>
57	<input type="checkbox"/>	<input type="text"/> ~ <input type="text"/>	<input type="text"/> ~ <input type="text"/>	TCP ▼	<input type="text"/>
58	<input type="checkbox"/>	<input type="text"/> ~ <input type="text"/>	<input type="text"/> ~ <input type="text"/>	TCP ▼	<input type="text"/>
59	<input type="checkbox"/>	<input type="text"/> ~ <input type="text"/>	<input type="text"/> ~ <input type="text"/>	TCP ▼	<input type="text"/>
60	<input type="checkbox"/>	<input type="text"/> ~ <input type="text"/>	<input type="text"/> ~ <input type="text"/>	TCP ▼	<input type="text"/>

TCP/UDP port filters

Setting	Description	Factory Default
Enable	Enables TCP/UDP port filters	Disable
Disable	Disables TCP/UDP port filters	

Policy

Setting	Description	Factory Default
Accept	Only the packets fitting the entities on list can be allowed.	Accept
Drop	Any packet fitting the entities on list will be denied.	



ATTENTION

Be careful when you enable the filter function:

Drop + "no entity on list is activated" = all packets are **allowed**

Accept + "no entity on list is activated" = all packets are **denied**

RSTP Settings (for Master or Slave mode only)

AWK-3131A supports IEEE 802.1D for Spanning Tree Protocol (STP) and IEEE 802.1w for Rapid STP standards. In addition to eliminating unexpected path looping, STP/RSTP can provide a backup path recovery if a wired/ wireless path fails accidentally. The reliability and availability can increase because this fail-over function.

AWK-3131A's STP/RSTP feature is disabled by default. To be completely effective, you must enable RSTP/STP on every AWK-3131A connected to your network. If AWK-3131A plays a **Slave** role, which is connected to a device (PLC, RTU, etc.) as opposed to network switch equipment, it is not necessary to enable STP/RSTP. The reason is that it will cause unnecessary negotiation. AWK-3131As support STP/RSTP in **Master or Slave mode** only.

The following figures indicate which Spanning Tree Protocol parameters can be configured. A more detailed explanation of each parameter is given below the figure.

RSTP Settings (WLAN is only for Master/Slave only)

Bridge priority

Hello time (1~10 seconds)

Forwarding delay (4~30 seconds)

Max age (6~40 seconds)

No	<input type="checkbox"/> Enable RSTP	Port Priority	Port Cost	<input type="checkbox"/> Edge Port
1 LAN	<input type="checkbox"/>	128	<input type="text" value="20000"/>	<input type="checkbox"/>
2 WLAN : Master	<input type="checkbox"/>	128	<input type="text" value="200000"/>	<input type="checkbox"/>



NOTE

The recovery time for STP/RSTP in firmware version 1.6 is around 25 to 35 seconds.

RSTP status

This field will appear only when selected to operate STP/RSTP. It indicates whether this AWK-3131A is the Root of the Spanning Tree (the root is determined automatically) or not.

Bridge priority

Setting	Description	Factory Default
Numerical value selected by user	You can increase the bridge priority by selecting a lower number. A higher bridge priority brings a greater chance of being established as the root of the Spanning Tree topology.	32768

Hello time

Setting	Description	Factory Default
Numerical value input by user (1 – 10 seconds)	The root of the Spanning Tree topology periodically sends out a "hello" message to other devices on the network to check if the topology is healthy. Hello time indicates how often the root sends hello messages.	2 (seconds)

Forwarding delay

Setting	Description	Factory Default
Numerical value input by user (4 to 30 seconds)	The amount of time this device waits before checking to see if it should change to a different topology.	15 (seconds)

Max. age

Setting	Description	Factory Default
Numerical value input by user (6 to 40 seconds)	As a non-root role, if a device has not received a hello message from the root for a period longer than the Max. age, it will reconfigure itself as a root. Once two or more devices on the network are recognized as roots, the devices will renegotiate to set up a new Spanning Tree topology.	20 (seconds)

Enable RSTP

Setting	Description	Factory Default
Enable/Disable	Enables or disables the port as a node on the Spanning Tree topology.	Disable (unchecked)

Port priority

Setting	Description	Factory Default
Numerical value selected by user	Increase this port's priority as a node on the Spanning Tree topology by inputting a lower number.	128

Port cost

Setting	Description	Factory Default
Enable/Disable	Input a higher cost to indicate that this port is less suitable as a node for the Spanning Tree topology	2000000

Edge port

Setting	Description	Factory Default
Checked/Unchecked	Sets a port, which no BPDU expectedly goes through, as an edge port	Unchecked, except AP port



NOTE

We recommend you set an edge port for the port, which is connected to a non-STP/RSTP sub-network or an end device (PLC, RTU, etc.) as opposed to network equipment. This can prevent unnecessary waiting and negotiation of STP/RSTP protocol, and accelerate system initialization. When an edge port receives BPDUs, it can still function as an STP/RSTP port and start negotiation.

Setting an edge port is different from disabling STP/RSTP on a port. If you disable STP/RSTP, a port will not deal with STP/RSTP BPDUs at all.

Port Status

Port Status indicates the current Spanning Tree status of this port. Use **Forwarding** for normal transmission, or **Blocking** to block transmission.

Static Route (for Client-router mode only)

The Static Route page is used to configure the AWK-3131A's static routing table.

Static Route (For Client-Router mode only)						
No.	<input type="checkbox"/> Active	Destination	Netmask	Gateway	Metric	Interface
1	<input type="checkbox"/>	<input type="text"/>	<input type="text"/>	<input type="text"/>	<input type="text"/>	LAN ▼
2	<input type="checkbox"/>	<input type="text"/>	<input type="text"/>	<input type="text"/>	<input type="text"/>	LAN ▼
3	<input type="checkbox"/>	<input type="text"/>	<input type="text"/>	<input type="text"/>	<input type="text"/>	LAN ▼
4	<input type="checkbox"/>	<input type="text"/>	<input type="text"/>	<input type="text"/>	<input type="text"/>	LAN ▼
5	<input type="checkbox"/>	<input type="text"/>	<input type="text"/>	<input type="text"/>	<input type="text"/>	LAN ▼
6	<input type="checkbox"/>	<input type="text"/>	<input type="text"/>	<input type="text"/>	<input type="text"/>	LAN ▼
7	<input type="checkbox"/>	<input type="text"/>	<input type="text"/>	<input type="text"/>	<input type="text"/>	LAN ▼
8	<input type="checkbox"/>	<input type="text"/>	<input type="text"/>	<input type="text"/>	<input type="text"/>	LAN ▼
9	<input type="checkbox"/>	<input type="text"/>	<input type="text"/>	<input type="text"/>	<input type="text"/>	LAN ▼
10	<input type="checkbox"/>	<input type="text"/>	<input type="text"/>	<input type="text"/>	<input type="text"/>	LAN ▼
11	<input type="checkbox"/>	<input type="text"/>	<input type="text"/>	<input type="text"/>	<input type="text"/>	LAN ▼
12	<input type="checkbox"/>	<input type="text"/>	<input type="text"/>	<input type="text"/>	<input type="text"/>	LAN ▼
13	<input type="checkbox"/>	<input type="text"/>	<input type="text"/>	<input type="text"/>	<input type="text"/>	LAN ▼
14	<input type="checkbox"/>	<input type="text"/>	<input type="text"/>	<input type="text"/>	<input type="text"/>	LAN ▼
15	<input type="checkbox"/>	<input type="text"/>	<input type="text"/>	<input type="text"/>	<input type="text"/>	LAN ▼
16	<input type="checkbox"/>	<input type="text"/>	<input type="text"/>	<input type="text"/>	<input type="text"/>	LAN ▼

Active

Click the checkbox to enable Static Routing.

Destination

Specifies the destination IP address.

Netmask

Specifies the subnet mask for this IP address.

Gateway

Specifies the IP address of the router that connects the LAN to an outside network.

Metric

Specifies a "cost" for accessing the neighboring network.

Interface

Specifies the designated network interface for this routing rule.

NAT Settings/Port Forwarding (for Client-router mode only)

Network Address Translation (NAT) and Port Forwarding is supported in the AWK-3131A to facilitate the Client-Router operation mode. This feature translates the outgoing communication from private IPs to external IPs (WAN IP).

NAT/Port Forwarding (For Client-Router mode only)

NAT Settings

NAT mode Disable ▾

Port Forwarding Settings

Port forwarding Disable ▾

Setting	Description	Factory Default
NAT mode	Enable (N-1 NAT or 1-1 NAT) or disable the NAT mode.	Disable
Port Forwarding	Enable or disable the port forwarding function	Disable

N-1 NAT

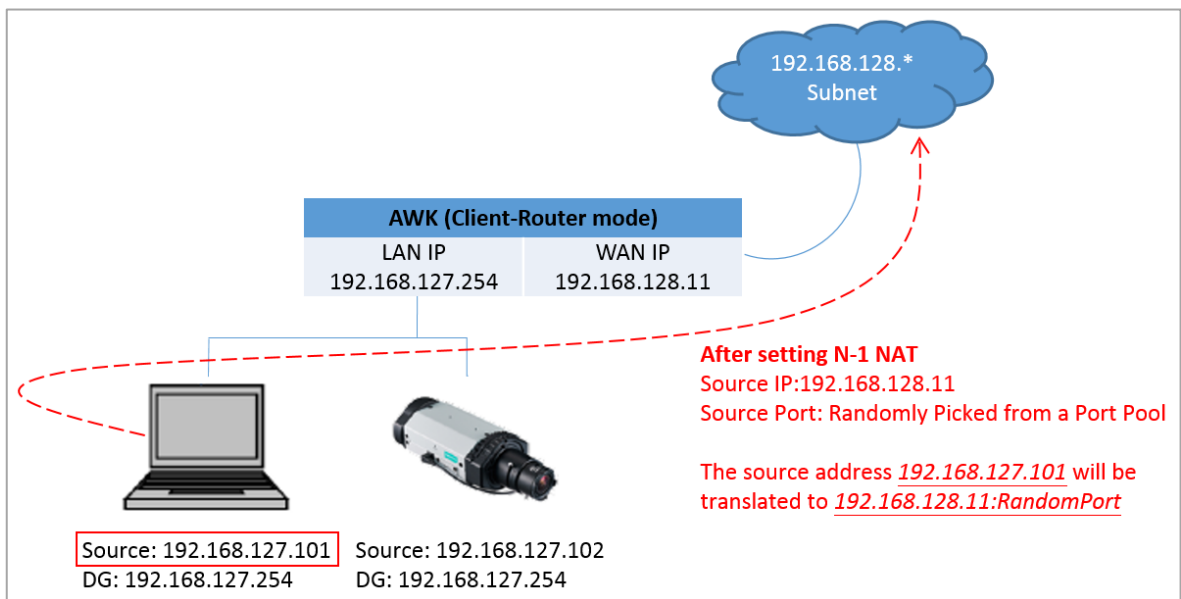

1-1 NAT

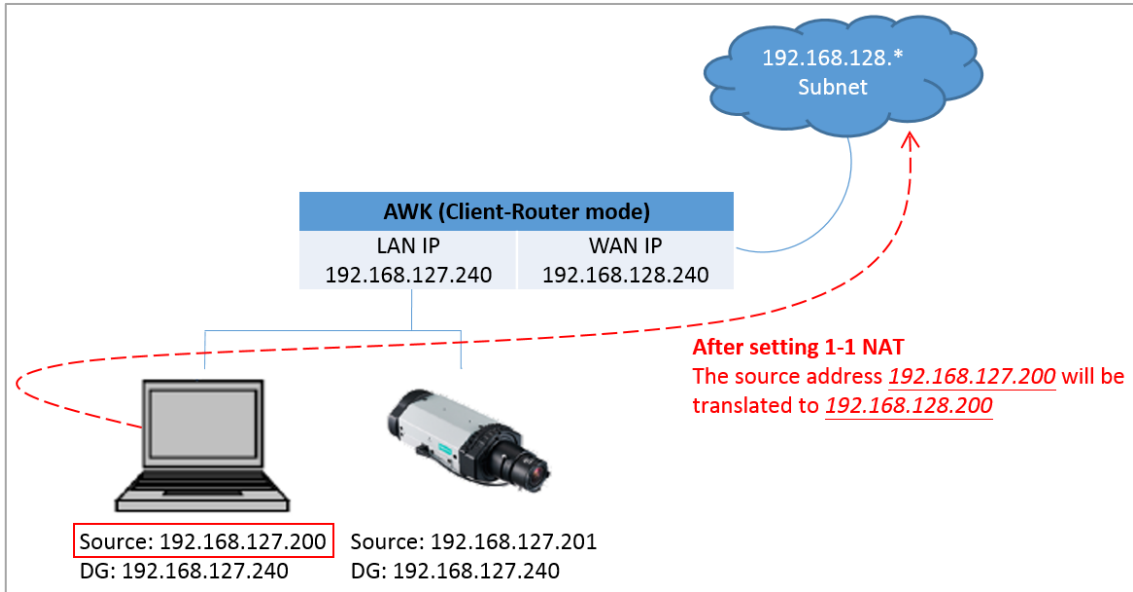

NAT Settings

NAT mode: 1-1 NAT

No.	<input type="checkbox"/> Active	WAN IP	LAN IP
1	<input type="checkbox"/>		
2	<input type="checkbox"/>		
3	<input type="checkbox"/>		
4	<input type="checkbox"/>		
5	<input type="checkbox"/>		
6	<input type="checkbox"/>		
7	<input type="checkbox"/>		
8	<input type="checkbox"/>		
9	<input type="checkbox"/>		
10	<input type="checkbox"/>		
11	<input type="checkbox"/>		
12	<input type="checkbox"/>		
13	<input type="checkbox"/>		
14	<input type="checkbox"/>		
15	<input type="checkbox"/>		
16	<input type="checkbox"/>		

Setting	Description
Active	Click the checkbox to enable 1-1 NAT
WAN IP	Specifies the "forward to" WAN IP
LAN IP	Specifies the "forward to" LAN IP

Port Forwarding

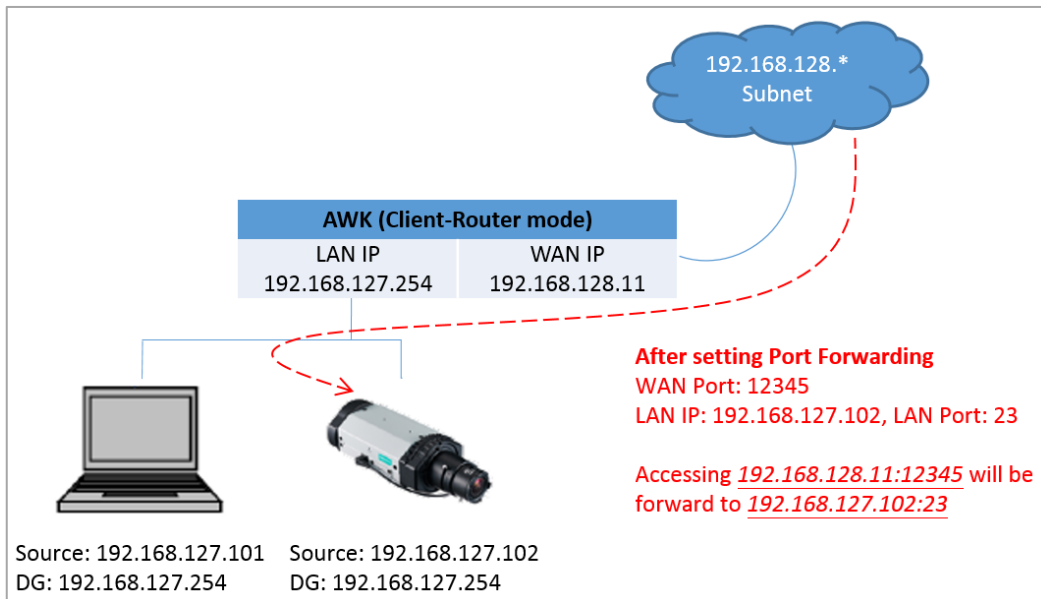

Port Forwarding Settings						
Port forwarding Enable <input type="checkbox"/>						
No.	<input type="checkbox"/> Active	Protocol	WAN Port	LAN IP	LAN Port	
1	<input type="checkbox"/>	TCP				
2	<input type="checkbox"/>	TCP				
3	<input type="checkbox"/>	TCP				
4	<input type="checkbox"/>	TCP				
5	<input type="checkbox"/>	TCP				
6	<input type="checkbox"/>	TCP				
7	<input type="checkbox"/>	TCP				
8	<input type="checkbox"/>	TCP				
9	<input type="checkbox"/>	TCP				
10	<input type="checkbox"/>	TCP				
11	<input type="checkbox"/>	TCP				
12	<input type="checkbox"/>	TCP				
13	<input type="checkbox"/>	TCP				
14	<input type="checkbox"/>	TCP				
15	<input type="checkbox"/>	TCP				
16	<input type="checkbox"/>	TCP				
17	<input type="checkbox"/>	TCP				
18	<input type="checkbox"/>	TCP				
19	<input type="checkbox"/>	TCP				
20	<input type="checkbox"/>	TCP				
21	<input type="checkbox"/>	TCP				
22	<input type="checkbox"/>	TCP				
23	<input type="checkbox"/>	TCP				
24	<input type="checkbox"/>	TCP				
25	<input type="checkbox"/>	TCP				
26	<input type="checkbox"/>	TCP				
27	<input type="checkbox"/>	TCP				
28	<input type="checkbox"/>	TCP				
29	<input type="checkbox"/>	TCP				
30	<input type="checkbox"/>	TCP				
31	<input type="checkbox"/>	TCP				
32	<input type="checkbox"/>	TCP				

Setting	Description
Active	Click the checkbox to enable Port Forwarding rule(s).
Protocol	Specifies the communication protocol.
WAN Port	Specifies the external port to be forwarded to
LAN IP	Specifies the "forward to" LAN IP
LAN Port	Specifies the "forward to" LAN Port

In order to allow external devices to initiate the communication, Port Forwarding is used to specify a static map between external ports (WAN Port) and internal IP/port combos (LAN IP/LAN Port), so as to allow external devices to initiate connection with this device.

SNMP Agent

The AWK-3131A supports SNMP V1/V2c/V3. SNMP V1 and SNMP V2c use a community string match for authentication, which means that SNMP servers access all objects with read-only or read/write permissions using the community string public/private (default value). SNMP V3, which requires you to select an authentication level of MD5 or SHA, is the most secure protocol. You can also enable data encryption to enhance data security.

SNMP security modes and security levels supported by the AWK-3131A are shown in the following table. Select the security mode and level that will be used to communicate between the SNMP agent and manager.

Protocol Version	Setting on UI web page	Authentication Type	Data Encryption	Method
SNMP V1, V2c	V1, V2c Read Community	Community string	No	Use a community string match for authentication
	V1, V2c Write/Read Community	Community string	No	Use a community string match for authentication
SNMP V3	No-Auth	No	No	Use account with admin or user to access objects
	MD5 or SHA	Authentication based on MD5 or SHA	No	Provides authentication based on HMAC-MD5, or HMAC-SHA algorithms. 8-character passwords are the minimum requirement for authentication.
	MD5 or SHA	Authentication based on MD5 or SHA	Data encryption key	Provides authentication based on HMAC-MD5 or HMAC-SHA algorithms, and data encryption key. 8-character passwords and a data encryption key are the minimum requirements for authentication and encryption.

The following parameters can be configured on the **SNMP Agent** page. A more detailed explanation of each parameter is given below the following figure.

SNMP Agent

SNMP agent Disable ▾

Remote management Disable ▾

Read community public

Write community private

SNMP agent version V1, V2c ▾

Admin authentication type No Auth ▾

Authentication username admin ▾

Admin encryption method Disable ▾

Private key [Text Field]

Private MIB information

Device object ID enterprise.8691.15.33

SNMP agent

Setting	Description	Factory Default
Enable	Enables SNMP agent	Disable
Disable	Disables SNMP agent	

Remote management

Setting	Description	Factory Default
Enable	Allow remote management via SNMP agent	Disable
Disable	Disallow remote management via SNMP agent	

Read community (for V1, V2c)

Setting	Description	Factory Default
V1, V2c Read Community	Use a community string match with a maximum of 31 characters for authentication. This means that the SNMP agent can access all objects with read-only permissions using this community string.	public

Write community (for V1, V2c)

Setting	Description	Factory Default
V1, V2c Read /Write Community	Use a community string match with a maximum of 31 characters for authentication. This means that the SNMP agent can access all objects with read/write permissions using this community string.	private

SNMP agent version

Setting	Description	Factory Default
V1, V2c, V3, or V1, V2c, or V3 only	Select the SNMP protocol version used to manage the switch.	V1, V2c

Admin auth type (for V1, V2c, V3, and V3 only)

Setting	Description	Factory Default
No Auth	Use admin account to access objects. No authentication	No Auth
MD5	Provide authentication based on the HMAC-MD5 algorithms. 8-character passwords are the minimum requirement for authentication.	
SHA	Provides authentication based on HMAC-SHA algorithms. 8-character passwords are the minimum requirement for authentication.	

Authentication username: Determines one account setting among 8 possible accounts as the SNMP authentication account setting when the authentication type is MD5/SHA.

Admin private key (for V1, V2, V3, and V3 only)

Setting	Description	Factory Default
Disable	No data encryption	Disable
DES	DES-based data encryption	
AES	AES-based data encryption	

Private key

A data encryption key is the minimum requirement for data encryption (maximum of 63 characters)

Private MIB Information Device Object ID

Also known as **OID**. This is the AWK-3131A's enterprise value. It is fixed.

Link Fault Pass-through (for Client/Slave mode only)

This function means if Ethernet port is link down, wireless connection will be forced to disconnect. Once Ethernet link is recovered, AWK will try to connect to AP.

If wireless is disconnected, AWK restarts auto-negotiation on Ethernet port but always stays in the link failure state. Once the wireless connection is recovered, AWK will try to recover the Ethernet link.

System log will indicate the link fault pass through events in addition to the original link up/down events.

Link Fault Pass-Through (For Client/Slave mode only)

Link Fault Pass-Through Enable Disable

Link Fault Pass-Through

Setting	Description	Factory Default
Enable	Enables Link Fault Pass-Through	Disable
Disable	Disables Link Fault Pass-Through	



NOTE

Auto MAC Cloning cannot be used together with Link Fault Pass Through.

Gratuitous ARP (for Client/Client-router mode only)

Gratuitous ARP is a broadcast packet that the client (the device) sends to all nodes to share or update the latest IP/MAC mapping table to prevent nodes from dropping packets.

Gratuitous ARP (Client or Client-Router mode only)

Gratuitous ARP enable

Gratuitous ARP to LAN

Send period (10-1000 sec)

No.	IP Address	MAC Address
1	<input type="text"/>	<input type="text"/>
2	<input type="text"/>	<input type="text"/>
3	<input type="text"/>	<input type="text"/>
4	<input type="text"/>	<input type="text"/>

Gratuitous ARP enable

Setting	Description	Factory Default
Enable/Disable	Enable or disable Gratuitous ARP functionality. Enabling this function helps detect and prevent unstable connections.	Disable

When enabled, the function behaves differently depending on the operation mode of the device. Refer to the following descriptions:

- **Client** mode: You can enter the IP/MAC address of the legacy device connected to the Ethernet port of the AWK device. The AWK will send the GARP packet:
 - a. To **LAN** with the **user-defined IP/MAC address**. Sending GARP packets to LAN is configurable.
 - b. To **WLAN** with a **user-defined IP address** and its **own MAC address**.
- **Client-Router** mode: You need to enable **NAT** for GARP first to allow the server on the AP side to access the devices connected to the Ethernet ports of the AWK device. The AWK will send the GARP packet to WLAN as:
 - a. **N-to-1**: With its **own WAN IP** and **MAC address**.
 - b. **1-to-1**: With its **own WAN MAC address** and the **1-to-1 IP** configured by the user in the NAT configuration.

When Gratuitous ARP is enabled, the following options will be shown:

Gratuitous ARP to LAN

Setting	Description	Factory Default
Enable/Disable	Enable or disable sending Gratuitous ARP packets to LAN	Disable

Send Period

Setting	Description	Factory Default
10-1000 seconds	Specify the interval at which GARP packets are sent (in seconds).	180

IP Address/MAC Address

Setting	Description	Factory Default
IP/MAC address	The corresponding IP/MAC address of the devices under the client. You can specify up to 4 entries.	Empty



ATTENTION

When specifying an IP or MAC address, you must provide the associated IP or MAC address for that entry.

Logs and Notifications

Since industrial-grade devices are often located at the endpoints of a system, these devices will not always know what is happening elsewhere on the network. This means that these devices, including wireless APs or clients, must provide system maintainers with real-time alarm messages. Even when system administrators are out of the control room for an extended period, they can still be informed of the status of devices almost instantaneously when exceptions occur.

In addition to logging these events, the AWK-3131A supports different approaches to warn engineers automatically, such as SNMP trap, e-mail, and relay output. It also supports two digital inputs to integrate sensors into your system to automate alarms by email and relay output.

System Logs

System Log Event Types

Detailed information for grouped events is shown in the following table. Check the box for **Enable logging** to enable the grouped events. All default values are enabled (checked). The log for system events can be seen in **Status > System Logs**.

System Log Event Types	
Event Type	Enable Logging
System-related events	<input checked="" type="checkbox"/> Active
Network-related events	<input checked="" type="checkbox"/> Active
Configuration-related events	<input checked="" type="checkbox"/> Active
Power events	<input checked="" type="checkbox"/> Active
DI events	<input checked="" type="checkbox"/> Active

System-related events	Event is triggered when...
System warm start	The AWK-3131A is rebooted, such as when its settings are changed (IP address, subnet mask, etc.)
System cold start	The AWK-3131A is rebooted by power down
Watchdog triggers reboot	The AWK-3131A is rebooted by watchdog

Network-related events	Event is triggered when...
LAN link on	The LAN port is connected to a device or network
LAN link off	The port is disconnected (e.g., the cable is pulled out, or the opposing device shuts down)
Client joined/ left (for AP/Master mode)	A wireless client is associated or disassociated
WLAN connected to AP (for Client/Slave mode)	The AWK-3131A is associated with an AP
WLAN disconnected (for Client/Slave mode)	The AWK-3131A is disassociated from an AP
RSTP changed	The RSTP topology has changed
RSTP new root bridge ID	The RSTP changes its root bridge ID

Network-related events	Event is triggered when...
Client Roaming from previous AP to current AP (for Client/Slave mode)	A client roams from a previous AP to the current AP if the signal strength of the current AP is greater than the previous AP by a certain value
IP address conflict	The AWK-3131A has the same IP address as another device connected to the same subnet
Link fault pass-through LAN/WLAN connected because of WLAN/LAN up	The WLAN/LAN link is up and the Link fault pass-through (LFPT) enables the LAN/WLAN functionality
Link fault pass-through LAN/WLAN disconnected because of WLAN/LAN down	The WLAN/LAN link is down and the Link fault pass-through (LFPT) disables the LAN/WLAN functionality
Channel availability check over DFS frequency (for AP/Master mode)	The channel availability check (CAC) is started on channel [channel] at [frequency] GHz for 60 sec./ The channel availability check (CAC) task has been completed on channel [channel] at [frequency] GHz./ A radar signal is detected on channel [channel] at [frequency] GHz
AeroLink protection state	The AeroLink protection state changes AeroLink states: Initialize (init)/Discovery/Idle/Negotiation (nego) Back up/Active/Changed/Undefined (undef) AeroLink detection methods: SNR/Signal Strength/Disconnection

Configuration-related events	Event is triggered when...
Configuration Changed	A configuration item has been changed
Configuration file import via Web Console	The configuration file is imported to the AWK-3131A
Console authentication failure	An incorrect password is entered
Firmware upgraded	The AWK-3131A's firmware is updated
Loaded the configuration from ABC-01	The configuration is successfully loaded/there is an error loading the configuration from ABC-01
Saving configuration to ABC-01	The configuration is successfully saved/there is an error saving the configuration to ABC-01
ABC-01 failure	AWK-3131A cannot detect an ABC-01 at the console port
Configuration reset to default	The configuration is reset to factory default

Power events	Event is triggered when...
Power 1/2 transition (On -> Off)	The AWK-3131A is powered down in PWR1/2
PoE transition (On -> Off)	The AWK-3131A is powered down in PoE
Power 1/2 transition (Off -> On)	The AWK-3131A is powered via PWR1/2
PoE transition (Off -> On)	The AWK-3131A is powered via PoE

Syslog

This function provides the event logs for the Syslog server. The function supports up to three configurable Syslog servers and Syslog server UDP port numbers. When an event occurs, the event will be sent as a Syslog UDP packet to the specified Syslog servers.

Syslog Event Types

Detailed information for the grouped events is shown in the following table. Check the box for **Enable logging** to enable the grouped events. All default values are enabled (checked). Detailed descriptions of the event types are available in the System Logs section.

Syslog Event Types	
Event Type	Enable Logging
System-related events	<input checked="" type="checkbox"/> Active
Network-related events	<input checked="" type="checkbox"/> Active
Configuration-related events	<input checked="" type="checkbox"/> Active
Power events	<input checked="" type="checkbox"/> Active
DI events	<input checked="" type="checkbox"/> Active
RSSI report events	<input type="checkbox"/> Active

Submit

Syslog Server Settings

You can configure the parameters for your Syslog servers in this page.

Syslog Server Settings	
Syslog server 1	<input type="text"/>
Syslog port	<input type="text" value="514"/>
Syslog server 2	<input type="text"/>
Syslog port	<input type="text" value="514"/>
Syslog server 3	<input type="text"/>
Syslog port	<input type="text" value="514"/>

Submit

Syslog server 1/ 2/ 3

Setting	Description	Factory Default
IP address	Enter the IP address of the 1st/ 2nd/ 3rd Syslog Server	None

Syslog port

Setting	Description	Factory Default
Port destination (1 to 65535)	Enter the UDP port of the corresponding Syslog server	514



NOTE

The **RSSI report events (Only for Client mode)** event type is useful during the site survey stage and uses a special utility to draw RSSI table values. However, this function increases the traffic load; we recommend setting this function to **disable** during normal usage.

E-mail Notifications

Notification Event Types

Check the box for **Active** to enable the event items. All default values are deactivated (unchecked). Detailed descriptions of the event types are available in the System Logs section.

Notification Event Types	
Event Type	Enable Notification
Cold start	<input type="checkbox"/> Active
Warm start	<input type="checkbox"/> Active
Power 1 transition (On-->Off)	<input type="checkbox"/> Active
Power 1 transition (Off-->On)	<input type="checkbox"/> Active
Power 2 transition (On-->Off)	<input type="checkbox"/> Active
Power 2 transition (Off-->On)	<input type="checkbox"/> Active
PoE transition (On-->Off)	<input type="checkbox"/> Active
PoE transition (Off-->On)	<input type="checkbox"/> Active
Configuration changed	<input type="checkbox"/> Active
Console authentication failure	<input type="checkbox"/> Active
DI 1 transition (On-->Off)	<input type="checkbox"/> Active
DI 1 transition (Off-->On)	<input type="checkbox"/> Active
DI 2 transition (On-->Off)	<input type="checkbox"/> Active
DI 2 transition (Off-->On)	<input type="checkbox"/> Active
LAN link on	<input type="checkbox"/> Active
LAN link off	<input type="checkbox"/> Active

E-mail Server Settings

You can set up to 4 e-mail addresses to receive alarm emails from the AWK-3131A. The following parameters can be configured on the **E-mail Server Settings** page. In addition, a **Send Test Mail** button can be used to test whether the Mail server and e-mail addresses work well. More detailed explanations about these parameters are given after the following figure.

E-mail Server Settings	
Mail server (SMTP)	<input type="text"/>
User name	<input type="text"/>
Password	<input type="text"/>
From e-mail address	<input type="text"/>
To e-mail address 1	<input type="text"/>
To e-mail address 2	<input type="text"/>
To e-mail address 3	<input type="text"/>
To e-mail address 4	<input type="text"/>

Mail server (SMTP)

Setting	Description	Factory Default
IP address	The IP Address of your email server.	None

User name & Password

Setting	Description	Factory Default
-	User name and password used in the SMTP server	None

From e-mail address

Setting	Description	Factory Default
Max. 63 characters	Enter the administrator's e-mail address which will be shown in the "From" field of a warning e-mail.	None

To E-mail address 1/ 2/ 3/ 4

Setting	Description	Factory Default
Max. 63 characters	Enter the receivers' e-mail addresses.	None

Relay

The AWK-3131A has one relay output, which consists of 2 terminal block contacts on the AWK-3131A's top panel. These relay contacts are used to indicate user-configured events and system failure.

The two wires attached to the relay contacts form an open circuit when a user-configured event is triggered. If a user-configured event does not occur, the relay circuit will remain closed. For safety reasons, the relay circuit is kept open when the AWK-3131A is not powered.

Relay Event Types

You can check the box for **Active** to enable the event items. All default values are deactivated (unchecked). Detailed descriptions of the event types are available in the System Logs section.

Relay Event Types	
Event Type	Enable Notification
Power 1 transition (On-->Off)	<input type="checkbox"/> Active
Power 2 transition (On-->Off)	<input type="checkbox"/> Active
DI 1 transition (On-->Off)	<input type="checkbox"/> Active
DI 1 transition (Off-->On)	<input type="checkbox"/> Active
DI 2 transition (On-->Off)	<input type="checkbox"/> Active
DI 2 transition (Off-->On)	<input type="checkbox"/> Active
LAN link on	<input type="checkbox"/> Active
LAN link off	<input type="checkbox"/> Active

Trap

Traps can be used to signal abnormal conditions (notifications) to a management station. This trap-driven notification can make your network more efficient.

Because a management station usually takes care of a large number of devices that have a large number of objects, it will be overloading for the management station to poll or send requests to query every object on every device. It would be better if the managed device agent could notify the management station by sending a message known as a trap for the event.

Trap Event Types

Trap Event Types	
Event Type	Enable Notification
Cold start	<input type="checkbox"/> Active
Warm start	<input type="checkbox"/> Active
Power 1 transition (On-->Off)	<input type="checkbox"/> Active
Power 1 transition (Off-->On)	<input type="checkbox"/> Active
Power 2 transition (On-->Off)	<input type="checkbox"/> Active
Power 2 transition (Off-->On)	<input type="checkbox"/> Active
PoE transition (On-->Off)	<input type="checkbox"/> Active
PoE transition (Off-->On)	<input type="checkbox"/> Active
Configuration changed	<input type="checkbox"/> Active
Console authentication failure	<input type="checkbox"/> Active
DI 1 transition (On-->Off)	<input type="checkbox"/> Active
DI 1 transition (Off-->On)	<input type="checkbox"/> Active
DI 2 transition (On-->Off)	<input type="checkbox"/> Active
DI 2 transition (Off-->On)	<input type="checkbox"/> Active
LAN link on	<input type="checkbox"/> Active
LAN link off	<input type="checkbox"/> Active

Submit

SNMP Trap Receiver Settings

SNMP traps are defined in SMIV1 MIBs (SNMPv1) and SMIV2 MIBs (SNMPv2c). The two styles are basically equivalent, and it is possible to convert between the two. You can set the parameters for SNMP trap receivers through the web page.

SNMP Trap Receiver Settings	
1st trap version	V1 ▾
1st trap server IP/name	<input type="text"/>
1st trap community	alert <input type="text"/>
2nd trap version	V1 ▾
2nd trap server IP/name	<input type="text"/>
2nd trap community	alert <input type="text"/>

Submit

1st / 2nd trap version

Setting	Description	Factory Default
V1	SNMP trap defined in SNMPv1	V1
V2	SNMP trap defined in SNMPv2	

1st / 2nd trap server IP/name

Setting	Description	Factory Default
IP address or host name	Enter the IP address or name of the trap server used by your network.	None

1st / 2nd trap community

Setting	Description	Factory Default
Max. of 31 characters	Use a community string match with a maximum of 31 characters for authentication.	Alert

Status

Wireless LAN Status

The status for **802.11 Information** parameters, such as Operation mode and Channel, are shown on the **Wireless Status** page. The status will refresh every 5 seconds if the **Auto refresh** box is checked.

Certain values for **802.11 Information** may not show up due to different operation modes. As a result, **Current BSSID**, **Signal strength**, and **SNR** are not available in AP mode.

It is helpful to use the continuously updated information on this page, such as **Signal strength**, **Noise floor**, and **SNR**, to monitor the signal strength of the AWK-3131A in Client mode.

Wireless LAN Status	
<input checked="" type="checkbox"/> Auto Update	
Show status of	WLAN (SSID: MOXA) ▼
802.11 Information	
Operation mode	AP
Channel	6
Channel width	N/A
RF type	B/G/N Mixed
SSID	MOXA
MAC	06:90:E8:11:22:33
Security mode	OPEN
Current BSSID	06:90:E8:11:22:33
Signal strength	N/A
Signal strength	-95 dBm
Noise floor	-95 dBm
SNR	N/A
Transmission Information	
Rate	Auto
Power	20 dBm
Outgoing Packets	
Total sent	2298
Packets with errors	0
Packets dropped	46662
Incoming Packets	
Total received	1391
Packets with errors	0
Packets dropped	0

Associated Client List (for AP/Master mode only)

The Associated Client List shows all the clients that are currently associated with a particular AWK-3131A. This page provides useful information for easier network diagnosis:

MAC Address: Displays the associated client MAC address. If DHCP server is enabled on this AP/Master, the IP address will also be displayed.

Connection Duration: States how long the client has been connecting to this AP/Master.

SNR/Signal Strength: States the Signal-Noise Ratio/Signal Strength of the associated client. This is especially useful for identifying a weak signal client that is potentially reducing the overall wireless performance.

Tx (Bytes/Pkts): Records the AP-to-client traffic after a client is associated.

Rx (Bytes/Pkts): Records the client-to-AP traffic after a client is associated.

Associated Client List								
Show clients for WLAN (SSID: u)								
No.	MAC Address	Connection Duration	SNR	Signal Strength	Tx (Bytes)	Tx (Pkts)	Rx (Bytes)	Rx (Pkts)
1	00:90:e8:00:05:6e (192.168.127.254)	1 days 01h:12m:38s	53	-40	545091	631	59966	593

Refresh

DHCP Client List (for AP mode only)

The DHCP Client List shows all the clients that require and have successfully received IP assignments. You can click the **Refresh** button to refresh the list.

DHCP Client List		
	MAC	IP
1.	01:5C:96:9D:29:77:71	192.168.41.229
2.	01:30:10:B3:72:72:7F	192.168.41.142
3.	01:9C:4E:36:A6:98:08	192.168.41.216
4.	01:B4:CE:F6:4E:CB:3C	192.168.41.146
5.	01:90:B6:86:75:A5:28	192.168.41.184
6.	01:8C:70:5A:49:FF:58	192.168.41.127
7.	01:68:09:27:CD:41:43	192.168.41.143
8.	01:5C:C5:D4:75:50:7B	192.168.41.140
9.	01:84:3A:4B:39:B7:5C	192.168.41.181
10.	01:A4:C3:61:03:F0:E2	192.168.41.137
11.	* 192.168.41.226	
12.	01:80:86:F2:B2:65:1F	192.168.41.222
13.	01:34:4D:F7:3A:23:FB	192.168.41.122
14.	01:30:75:12:A7:15:0E	192.168.41.139
15.	01:EC:85:2F:88:B3:6A	192.168.41.213
16.	01:30:75:12:F2:59:F9	192.168.41.125
17.	01:78:6C:1C:BF:51:0E	192.168.41.144
18.	01:AC:81:12:59:66:2F	192.168.41.156

Select All Refresh

You can press **Select all** button to select all content in the list for further editing.

	MAC	IP
1.	00:13:ce:e1:ee:ef	192.168.127.2

Select all Refresh

System Logs

Triggered events are recorded in System Log. You can export the log contents to an available viewer by clicking **Export Log**. You can use the **Clear Log** button to clear the log contents and the **Refresh** button to refresh the log.

System Logs

```
( 983) 2015/05/28,04h:12m:54s System warm start, restarted by console
( 984) 2015/05/28,04h:19m:19s LAN link off
( 985) 2015/05/28,04h:19m:21s LAN link on
( 986) 2015/05/28,07h:45m:59s Configuration changed
( 987) 2015/05/28,07h:46m:23s Power 1 transition (Off -> On)
( 988) 2015/05/28,07h:46m:29s LAN link on
( 989) 2015/05/28,07h:46m:34s System warm start, restarted by console
( 990) 2015/05/28,08h:14m:07s LAN link off
( 991) 2015/05/28,08h:14m:09s LAN link on
( 992) 2015/05/28,08h:21m:55s Configuration changed
( 993) 2015/05/28,08h:22m:20s Power 1 transition (Off -> On)
( 994) 2015/05/28,08h:22m:26s WLAN disconnected, connect time(0sec), (reason 0)
( 995) 2015/05/28,08h:22m:26s LAN link on
( 996) 2015/05/28,08h:22m:29s System warm start, restarted by console
( 997) 2015/05/28,08h:24m:24s Configuration changed
( 998) 2015/05/28,08h:24m:49s Power 1 transition (Off -> On)
( 999) 2015/05/28,08h:24m:55s LAN link on
(1000) 2015/05/28,08h:24m:59s System warm start, restarted by console
```

▲
▼

Export Log Clear Log Refresh

Relay Status

The status of user-configurable events can be found under **Relay Status**. The status will refresh every 5 seconds if the **Auto refresh** box is checked.

If an event is triggered, it will be noted on this list. System administrators can click **Acknowledge Event** when he has acknowledged the event and addressed it.

Relay Status

Auto Update

Relay Status		
Power 1 transition (On-->Off)	---	Acknowledge Event
Power 2 transition (On-->Off)	---	Acknowledge Event
DI 1 transition (On-->Off)	---	Acknowledge Event
DI 1 transition (Off-->On)	---	Acknowledge Event
DI 2 transition (On-->Off)	---	Acknowledge Event
DI 2 transition (Off-->On)	---	Acknowledge Event
LAN link on	---	Acknowledge Event
LAN link off	---	Acknowledge Event

DI and Power Status

The status of power inputs and digital inputs is shown on this web page. The status will refresh every 5 seconds if the **Auto refresh** box is checked.

DI and Power Status	
<input checked="" type="checkbox"/> Auto Update	
Input Status	On / Off
Power 1 status	On
Power 2 status	Off
PoE status	Off
DI 1 status	Off
DI 2 status	Off

AeroLink Protection Status (for Client/Slave mode only)

After you have enabled AeroLink Protection in the **Advanced WLAN Setup** panel, the current state of the AeroLink Protection is displayed here for easy diagnosis.

AeroLink Protection Status	
<input checked="" type="checkbox"/> Auto Update	
AeroLink Protection Status	
Current state	N/A (Init/Discover/Idle/Nego/Backup/Active/Change)
Detection method	N/A (SNR/Signal Strength/Disconnection)

A member of the AeroLink Protection group can take one of the following seven states:

- **Initiation State (Init):** Initiates the AeroLink Protection Protocol
- **Discovering State (Discover):** Discovers other AeroLink Protection members for further negotiation
- **Idle State (Idle):** Internal protocol checkpoint
- **Negotiation State (Nego):** Negotiates with other AeroLink Protection members and elects an Active node.
- **Backup State (Backup):** After negotiation, this node is assigned as a Backup node. All traffic will go through the Active node instead.



NOTE

When a node is in Backup state, the STATE LED will be blinking.

- **Active State (Active):** After negotiation, this node is assigned as Active node, which means that all traffic will go through this node.
- **Role Change State (Change):** If the Active node is no longer capable of data transmission via the WLAN, it will turn into Change State to trigger the re-negotiation of the Active node from the Backup nodes.

AeroLink Protection function can adopt one of the following detection methods:

- **SNR:** Checks the Signal-Noise Ratio (SNR) of the associated client
- **Signal Strength:** Checks the Signal Strength of the associated client
- **Disconnection:** Checks for disconnection

System Status

The system status section indicates the status of the device memory and CPU usage in the current device.



NOTE

A CPU overload can result in a watchdog-triggered reboot of the system. Factors such as a high number of firewall rules (IP/MAC/Protocol filters) and traffic PPS (packet per second) contribute to the rise in CPU usage.

System Status		
Memory Info		
Total	(kB)	126724
Used	(kB)	48604
Free	(kB)	78120
CPU Info		
Usage	(%)	4.33

Network Status

The network status section indicates the network status of the device with respect to ARP, bridge status, LLDP, RSTP, and the routing table.

ARP Table

Address Resolution Protocol (ARP) Table - indicates the current IP to MAC address mapping for the device.

ARP Table	
IP Address	MAC Address
192.168.127.18	F0:DE:F1:DD:A1:ED

Bridge Status

Bridge Status indicates the current status of the network bridge on the device. The interfaces and the corresponding MAC addresses in this section are the entry points for ingress traffic.

Bridge Status	
Interface	MAC Address
LAN	00:90:E8:22:B1:D9
ath01	00:90:E8:4E:9A:79
LAN	F0:DE:F1:DD:A1:ED

LLDP Status

Displays information on neighboring devices collected via LLDP (Link Layer Discovery Protocol).

LLDP Status					
Interface	Neighbor Information				
	System Name	ID	IP	Port	Port Description
LAN	AWK-3121_13496	00:90:E8:22:B1:D9 (MAC)	192.168.127.253	7 (LOCAL)	LAN
WLAN	AWK-3121_0777	00:90:E8:4E:9A:79 (MAC)	192.168.127.252	10 (LOCAL)	WLAN

Refresh



NOTE

The LLDP function in AWK-3131A does not support IEEE 802.3.

Routing Table

The Routing Table displays the routing information for the current device.

Routing Table			
Destination	Gateway	Mask	Interface
192.168.127.0	*	255.255.255.0	*
default	192.168.127.251	0.0.0.0	*

Refresh

RSTP Status

Displays the Spanning Tree Protocol parameters configured.

RSTP Status					
RSTP status	-----				
Bridge priority	32768				
Hello time	2 seconds				
Forwarding delay	15 seconds				
Max age	20 seconds				
No	Enable RSTP	Port Priority	Port Cost	Edge Port	Status

Maintenance

Maintenance functions provide the administrator with tools to manage the AWK-3131A and wired/wireless networks.

Console Settings

You can enable or disable access permission for the following consoles: HTTP, HTTPS, Telnet, and SSH connections. For more security, we recommend you only allow access to the two secured consoles, HTTPS and SSH.

Console Settings

Auto logout period: (1 to 60 minutes)

Accessible Interfaces

Interface	HTTP	HTTPS	Telnet	SSH	SNMP	Moxa Service
Enable services	<input type="checkbox"/>	<input checked="" type="checkbox"/>	<input type="checkbox"/>	<input checked="" type="checkbox"/>	<input type="checkbox"/>	<input checked="" type="checkbox"/>
Ethernet	<input checked="" type="checkbox"/>	<input checked="" type="checkbox"/>	<input checked="" type="checkbox"/>	<input checked="" type="checkbox"/>	<input checked="" type="checkbox"/>	<input checked="" type="checkbox"/>
WLAN	<input checked="" type="checkbox"/>	<input checked="" type="checkbox"/>	<input checked="" type="checkbox"/>	<input checked="" type="checkbox"/>	<input checked="" type="checkbox"/>	<input checked="" type="checkbox"/>

* If you disable all access portals, you will not be able to remotely access this device.
* If you disable HTTPS, some Moxa service features will be disabled.

Accessible Net List

Accessible Net List: Enable Disable

SSL Certificate (For HTTPS only)

SSL certificate enable: Enable Disable

Import SSL certificate file (PKCS12):

SSL certificate passphrase:

Ping

Ping helps to diagnose the integrity of wired or wireless networks. By inputting a node's IP address in the **Destination** field, you can use the **ping** command to make sure it exists and whether or not the access path is available.

Ping

Destination:

If the node and access path are available, you will see that all packets were successfully transmitted with no loss. Otherwise, some, or even all, packets may get lost, as shown in the following figure.

Ping

Destination:

```
PING 192.168.41.233 (192.168.41.233): 56 data bytes
64 bytes from 192.168.41.233: seq=0 ttl=64 time=0.696 ms
64 bytes from 192.168.41.233: seq=1 ttl=64 time=0.548 ms
64 bytes from 192.168.41.233: seq=2 ttl=64 time=0.565 ms
64 bytes from 192.168.41.233: seq=3 ttl=64 time=0.567 ms

--- 192.168.41.233 ping statistics ---
4 packets transmitted, 4 packets received, 0% packet loss
round-trip min/avg/max = 0.548/0.594/0.696 ms
```

Firmware Upgrade

The AWK-3131A can be enhanced with more value-added functions by installing firmware upgrades. The latest firmware is available at Moxa's download center.

Before running a firmware upgrade, make sure the AWK-3131A is off-line. Click the Browse button to specify the firmware image file and click Firmware Upgrade and Restart to start the firmware upgrade. After the progress bar reaches 100%, the AWK-3131A will reboot itself.

When upgrading your firmware, the AWK-3131A's other functions are forbidden.

Firmware Upgrade

Select firmware file



ATTENTION

Please make sure the power source is stable when you upgrade your firmware. An unexpected power breakup may damage your AWK-3131A.

Firmware upgrade may change the current roaming configuration. Please check the roaming configuration of the device after it reboots.

Configuration Import and Export

First way you can back up or restore the AWK-3131A's configuration with **Configuration Import & Export**.

In the **Configuration Import** section, click **Browse** to specify the configuration file and click **Import Configuration** button to begin importing the configuration.

Configuration Import & Export

Configuration Import

Select configuration file

In the **Configuration Export** section, click the **Export Configuration** button and save the configuration file onto your local storage media. The configuration file is a text file and you can view and edit it with a general text-editing tool.

Configuration Export

You can also back up or restore the ABC-01 configuration with **Config Import Export**.

ABC-01 Import

ABC-01 Export

The SNMP MIB file is also available from SNMP MIB File EXPORT.

SNMP MIB File Export

To download the configuration to the AWK:

1. Turn off the AWK.
2. Plug in the ABC-01 to the AWK's RS-232 console.
3. Turn on AWK.
4. AWK will detect the ABC-01 during the boot up process, and download the configuration from the ABC-01 to the AWK automatically. Once the configuration downloads correctly, the AWK emits three short beeps and then continues with the boot-up process.
5. Once the AWK has booted up successfully, it will emit the normal two beeps, and the ready LED will turn to solid green.

Load Factory Default

Use this function to reset the AWK-3131A and roll all settings (except for Basic WLAN indoor/outdoor settings) back to the factory default values. If you want to keep wireless enabled, select the "Enable" option for Wireless before clicking **System Reset**. You can also reset the hardware by pressing the reset button on the top panel of the AWK-3131A.

Load Factory Default

Choose the "Wireless Enable" setting and click "System Reset" to immediately restart the system to factory default values but keep the wireless enabled.

Wireless Enable Disable

Account Settings

To ensure that devices located at remote sites are secure from hackers, we recommend setting up a high-strength password the first time you configure the device.

Password Policy

Minimum password length (4 - 16 characters)

Password strength check

Password validity (0 - 365 days, 0 is disable)

Password retry count (0 - 10, 0 is disable)

Lockout time (60 - 3600 seconds)

Account List

No.	Active	Account Name	User Level	HTTP/HTTPS	Telnet/SSH /Console	Moxa Services	Diagnostics	Action	
1	<input checked="" type="checkbox"/>	admin	Admin	<input checked="" type="checkbox"/>	<input checked="" type="checkbox"/>	<input checked="" type="checkbox"/>	<input checked="" type="checkbox"/>	<input type="button" value="Edit"/>	<input type="button" value="Delete"/>
2	<input type="checkbox"/>		Admin	<input checked="" type="checkbox"/>	<input checked="" type="checkbox"/>	<input checked="" type="checkbox"/>	<input checked="" type="checkbox"/>	<input type="button" value="Edit"/>	<input type="button" value="Delete"/>
3	<input type="checkbox"/>		Admin	<input checked="" type="checkbox"/>	<input checked="" type="checkbox"/>	<input checked="" type="checkbox"/>	<input checked="" type="checkbox"/>	<input type="button" value="Edit"/>	<input type="button" value="Delete"/>
4	<input type="checkbox"/>		Admin	<input checked="" type="checkbox"/>	<input checked="" type="checkbox"/>	<input checked="" type="checkbox"/>	<input checked="" type="checkbox"/>	<input type="button" value="Edit"/>	<input type="button" value="Delete"/>
5	<input type="checkbox"/>		Admin	<input checked="" type="checkbox"/>	<input checked="" type="checkbox"/>	<input checked="" type="checkbox"/>	<input checked="" type="checkbox"/>	<input type="button" value="Edit"/>	<input type="button" value="Delete"/>
6	<input type="checkbox"/>		Admin	<input checked="" type="checkbox"/>	<input checked="" type="checkbox"/>	<input checked="" type="checkbox"/>	<input checked="" type="checkbox"/>	<input type="button" value="Edit"/>	<input type="button" value="Delete"/>
7	<input type="checkbox"/>		Admin	<input checked="" type="checkbox"/>	<input checked="" type="checkbox"/>	<input checked="" type="checkbox"/>	<input checked="" type="checkbox"/>	<input type="button" value="Edit"/>	<input type="button" value="Delete"/>
8	<input type="checkbox"/>		Admin	<input checked="" type="checkbox"/>	<input checked="" type="checkbox"/>	<input checked="" type="checkbox"/>	<input checked="" type="checkbox"/>	<input type="button" value="Edit"/>	<input type="button" value="Delete"/>

* Only characters allowed in the Account Name are alphabets, numerals, at sign (@), period (.), and underscore(_).

Field	Description	Default setting
Minimum password length	By default, passwords can be between 4 and 16 characters. For improved security, we recommend changing the minimum password length to at least 8 characters the first time you configure the device.	4
Password strength check	Enable the password strength check option to ensure that users are required to select high-strength passwords. NOTE: See the Change Password section below for details.	Disable
Password validity	The number of days after which the password must be changed. Passwords should be updated regularly to protect against hackers.	90 days
Password retry count	The number of consecutive times a user can enter an incorrect password while logging in before the device's login function is locked.	5
Lockout time	The number of seconds the device's login function will be locked after n consecutive unsuccessful login attempts, where n = the password retry count.	600 seconds

Click **Edit** to create a new, or edit an existing, user account. The items shown below can be configured.

Account Settings

Active Enable ▾

User level Admin ▾

Account name (A-Z, a-z, 0-9, '@', '.', and '_')

New Password

Confirm Password

- Your password must follow the password policy.
- The minimum password length is 4 characters.

Accessible Access Portal

HTTP/HTTPS Enable Disable

Telnet/SSH/Console Enable Disable

Moxa Service Enable Disable

Diagnostic Enable Disable

Field	Description	Default Setting
Active	Select Enable to enable the user account.	Disable
User level	Administrator: Allows the user to access the Web UI, change the device's configuration, and use the device's import/export capability. User: Allows the user to access the Web UI, but the user will not be able to change the device's configuration or use the device's import/export capability.	Admin
Account name	The username of the account.	Admin
New Password	The password used to log in to the device.	moxa
Confirm Password	Retype the password. If the Confirm Password and New Password fields do not match, you will be asked to reenter the password.	N/A

Change Password

Use the **Change Password** function to change the password of existing user accounts. First input the current password, and then type the new password in the **New password** and **Confirm password** input boxes.



NOTE

To maintain a higher level of network security, do not use the default password (moxa), and be sure to change all user account passwords regularly.

Change Password

Current password

New password

Confirm password

- Your password must follow the password policy.
- The minimum password length is 4 characters.



NOTE

If the **Password-strength test** option is enabled, you will be prompted to use passwords that adhere to the following password policy:

- The password must contain at least one digit: 0, 1, 2, ..., 9.
- The password must contain both upper and lower case letters: A, B, ..., Z, a, b, ..., z.
- The password must contain at least one of the following special characters: ~!@#%^_~:;,.<>[]{}.
- The password cannot contain the following special characters: ` ' " | ; & \$.
- The password must have more characters than the minimum password length (default = 4).
- Starting with the firmware version 1.4, the default password is **moxa**. For all previous firmware versions (up to 1.3), the default password is **root**.

Misc. Settings

Additional settings to help you manage your AWK-3131A are available on this page.

Miscellaneous Settings

Reset button Always enable Disable factory reset function after 60 seconds.

Allow special characters Enable Disable

Reset button

Setting	Description	Factory Default
Always Enable	The AWK-3131A's Reset button works normally.	Always enable
Disable the Factory Reset Function after 60 Seconds	The AWK-3131A's reset to default function will be inactive 60 seconds after the AWK-3131A finishes booting up.	

Allow special characters

Setting	Description	Factory Default
Enable/disable	Allow or prohibit the use of special characters (` ' " ; & \$). For security reasons, we recommend disabling special characters.	Disable

Troubleshooting

This feature allows you to quickly obtain the current system status and provide diagnostics information to Moxa engineers.

To export the current device information, click **Export**. If more detailed Wi-Fi information is required, enable **Wi-Fi Analysis** and then click **Export**. Retrieving the additional information may take up to 3 minutes.

Troubleshooting

Export current device information Wi-Fi analysis (It takes about 3 minutes.)

Wi-Fi Mirror Port

A Wi-Fi mirror port can help you obtain the current Wi-Fi communication behavior of your network over the current channel when it is not convenient to set up a Wi-Fi sniffer in the system operating environment.

Wi-Fi Mirror Port

Capture Wi-Fi Frames (1~180s)

Remote Capture Enable Disable

To setup a Wi-Fi mirror port, you will need a computer with the Wireshark tool installed, which will be used to connect to the AWK device via the Ethernet.



NOTE

A Wi-Fi mirror port is useful for gathering information. However, the DFS function may not work properly when you enable the Wi-Fi Mirror Port function. Hence, we recommend disabling the Wi-Fi Mirror Port function during normal usage.

To set up a Wi-Fi mirror port for short-term monitoring, do the following:

1. Enter the duration in the **Capture Wi-Fi Frames** box.
You can enter a value between 1 to 180 seconds.
2. Click **Capture**
3. Wait for a timeout on the web console
You will be able to download a report from the web browser.

To set up a Wi-Fi mirror port for long-term monitoring, do the following:

1. On the **Wi-Fi Mirror Port** page, set the **Remote Capture** option to **Enable**.
2. Run the Wireshark tool on your computer, click **Capture** and then click **Options**.
3. In the **Input** tab of the Wireshark tool, click **Manage Interfaces**.

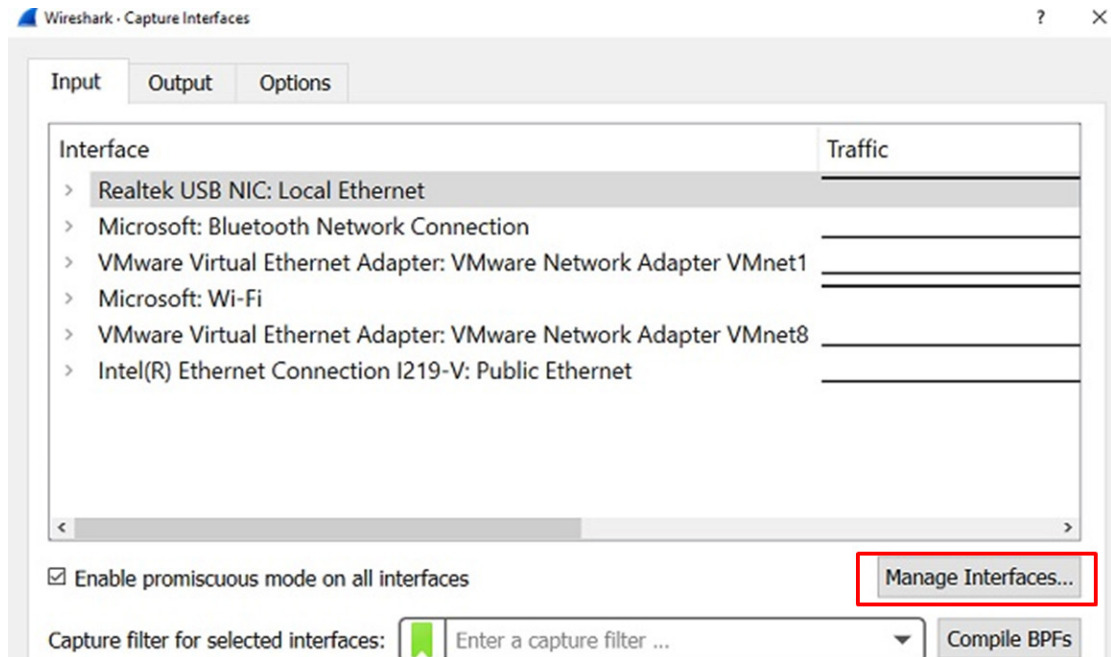

4. Click **Remote Interfaces** and add a new interface
5. Enter the information for your AWK device
 - **Port:** 2002
 - **Auth:** Null authentication
 - **Host:** <AWK IP>
6. Click **OK**

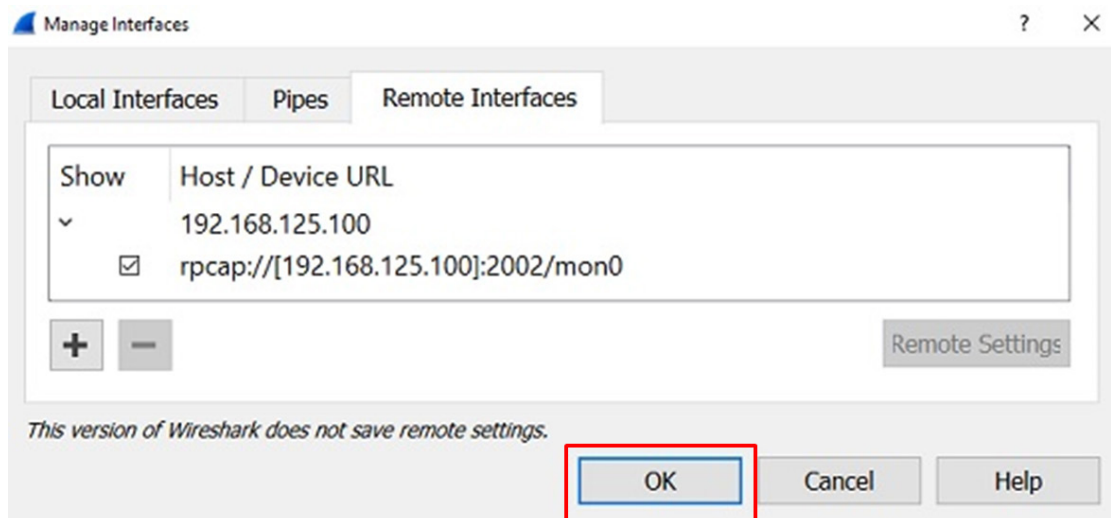

7. Select Input > Interface > rpcap://...:2002/mon0

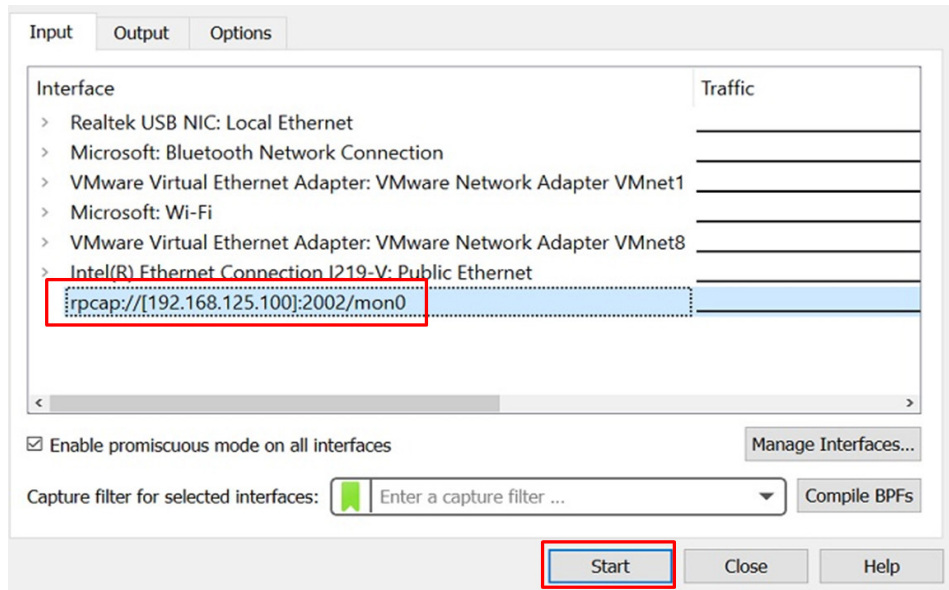

Diagnostics

For cases where advanced troubleshooting is required, Moxa Service Center will send you an encrypted script file. The script file can capture additional details on the system.

To run the script, browse to and select the script file using **Browse** and click **Run Script** after you have filled in the following details:

Diagnostics	
Diagnostic script	<input type="button" value="Browse..."/>
Export diagnostic results	<input checked="" type="radio"/> to a file <input type="radio"/> to a TFTP server
TFTP server IP	<input type="text"/>
Diagnostic script name	N/A
Last start time	N/A
Last end time	N/A
Diagnostic status	<input type="text"/>
Diagnostic result	N/A
<input type="button" value="Run Script"/> <input type="button" value="Stop Script"/>	

Setting	Description
Diagnostic script	Use the Browse button to select the Moxa diagnosis script file.
Export diagnostic results	Select if you want to export to a file or to a TFTP server
TFTP server IP	If you have selected the TFTP option, specify the IP address of the TFTP server.
Diagnostic script name	Displays the name of the script file
Last start time	Displays the start time of the last script execution
Last end time	Displays the end time of the last script execution
Diagnostic status	Displays the progress of the system diagnostics
Diagnostic result	Displays the result of the system diagnostics. If you have selected the export to a file option, the system log is encrypted and packed into a file. The limit on the log file size is 1 MB. When the size of the log file reaches 1MB another file is created. A maximum of 5 files (5MB) will be kept for downloading. When the number of files exceeds five, the oldest file is deleted.

Remote Diagnostics

If technical support from a Moxa engineer is needed, admin level users can enable remote diagnostics through HTTPS. This feature will generate a temporary account and password that will be used by Moxa support engineers to perform remote diagnostics on your device. When completed, we recommend disabling this feature again, which will remove all the temporary account information.



NOTE

Remote diagnostics is only available for administrator-level users.

Remote Diagnostics

Remote Diagnostic Enable Disable

Remote Diagnostics CA

Warning:
 Enabling this feature will generate a temporary account and password that will be used by Moxa support engineers to perform remote diagnostics of your device.
 Disabling this feature will disable remote diagnostics and will erase all temporary account credentials.
 Enabling this feature will temporarily disable Telnet until this feature get disabled.

Setting	Description
Remote Diagnostics	Enable this option to allow remote technical support from Moxa engineers.
Remote Diagnostics CA	When enabled, the Moxa engineer will request the admin to provide the AWK's serial number and MAC address to generate a certificate file. Click Browse and upload the certificate file and then click Generate Security Key . When completed, click Export Security Key to generate a file named remoteSecurityKey and send this key to the support engineer.

Save Configuration

The following figure shows how the AWK-3131A stores the setting changes into volatile and non-volatile memory. All data stored in volatile memory will disappear when the AWK-3131A is shutdown or rebooted. Because the AWK-3131A starts up and initializes with the settings stored in flash memory, all new changes must be saved to flash memory before restarting the AWK-3131A.

This also means the new changes will not work unless you run either the **Save Configuration** function or the **Restart** function.

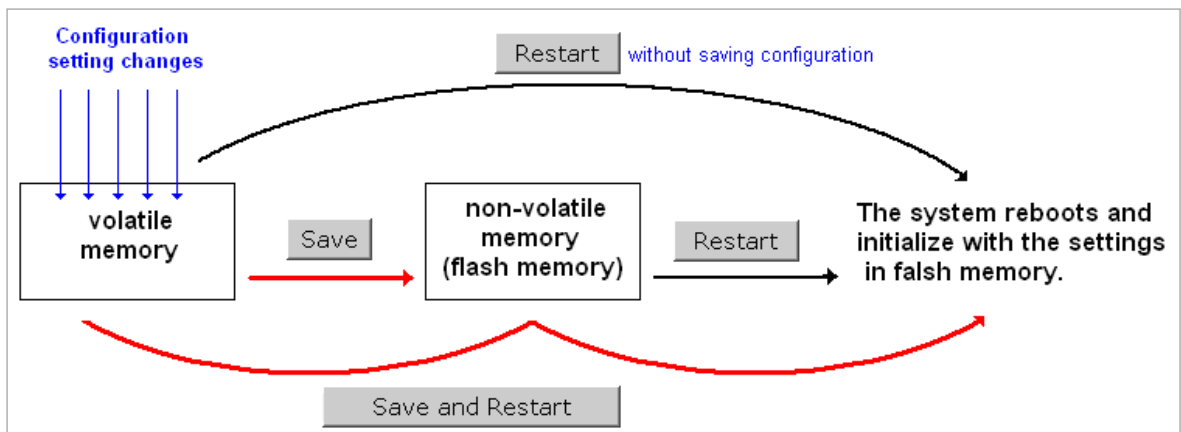

After you click on **Save Configuration** in the left menu box, the following screen will appear. Click **Save** if you wish to update the configuration settings in the flash memory at this time. Alternatively, you may choose to run other functions and put off saving the configuration until later. However, the new setting changes will remain in the non-volatile memory until you save the configurations.

Save Configuration

After you submit configuration changes, you must save the changes and restart the system to make the changes take effect. Click **Save** to save configuration changes in the system memory. Click **Restart** to activate configuration changes and display the active settings in the web console.

Network Settings After Reboot

Network Info	
LAN IP address	192.168.43.104
LAN subnet mask	255.255.252.0
LAN gateway	192.168.43.254

Restart

If you submitted configuration changes, you will find a blinking string in the upper right corner of the screen. After making all your changes, click the **Restart** function in the left menu box. One of two different screens will appear.

If you made changes recently but did not save, you will be given two options. Clicking the **Restart** button here will reboot the AWK-3131A directly, and all setting changes will be ignored.

Clicking the **Save and Restart** button will apply all setting changes and then reboot the AWK-3131A.

Restart

!!! Warning !!!

Click "Restart" to discard configuration changes and restart the system.

Click "Save and Restart" to save configuration changes and restart the system.

Network Settings After Reboot

Network Info	
LAN IP address	192.168.43.104
LAN subnet mask	255.255.252.0
LAN gateway	192.168.43.254

If you run the **Restart** function without changing any configurations or saving all your changes, you will see just one **Restart** button on your screen.

Restart

!!! Warning !!!

The system will restart immediately after you click "Restart". All Ethernet connections will be disconnected.

Network Settings After Reboot

Network Info	
LAN IP address	192.168.43.104
LAN subnet mask	255.255.252.0
LAN gateway	192.168.43.254

You will not be able to run any of the AWK-3131A's functions while the system is rebooting.

Logout

Logout helps users disconnect the current HTTP or HTTPS session and go to the Login page. For security reasons, we recommend you logout before quitting the console manager.

Logout

Click **Logout** to log out of the web console.

4. Software Installation and Configuration

Overview

The Wireless Search Utility can be downloaded from the Moxa website at www.moxa.com.

Wireless Search Utility

Installing Wireless Search Utility

Once the Wireless Search Utility is downloaded, run the setup executable to start the installation.

1. Click **Next** when the **Welcome** screen opens to proceed with the installation.



2. Click **Next** to install program files to the default directory, or click **Browse** to select an alternate location.

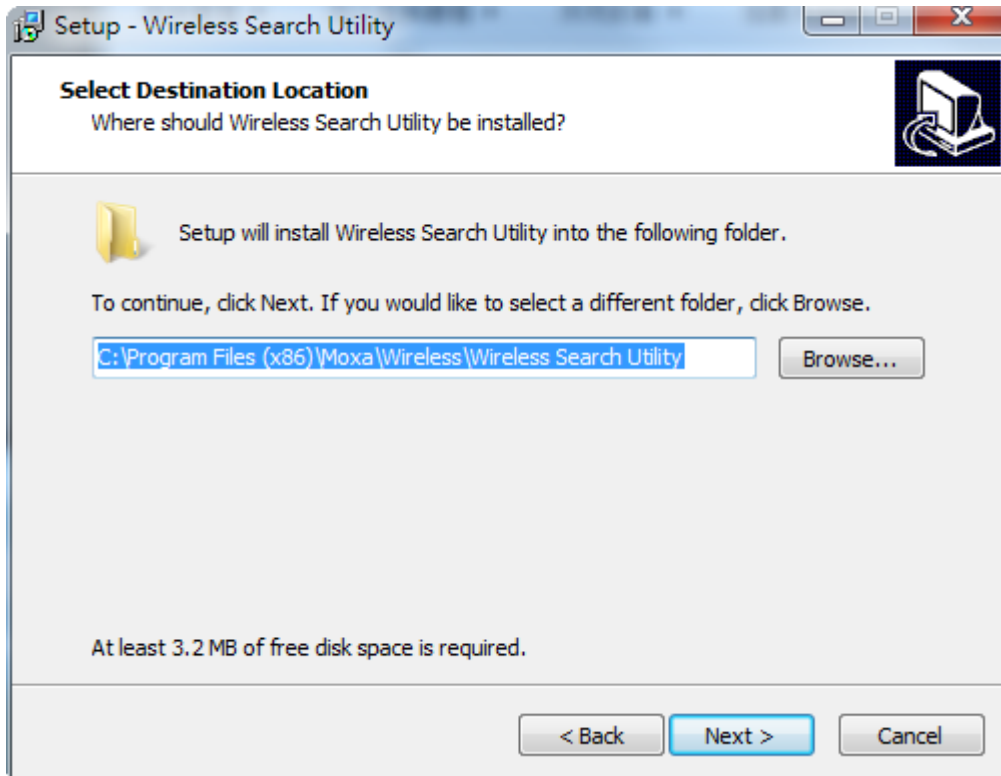

3. Click **Next** to create the program's shortcut files to the default directory, or click **Browse** to select an alternate location.

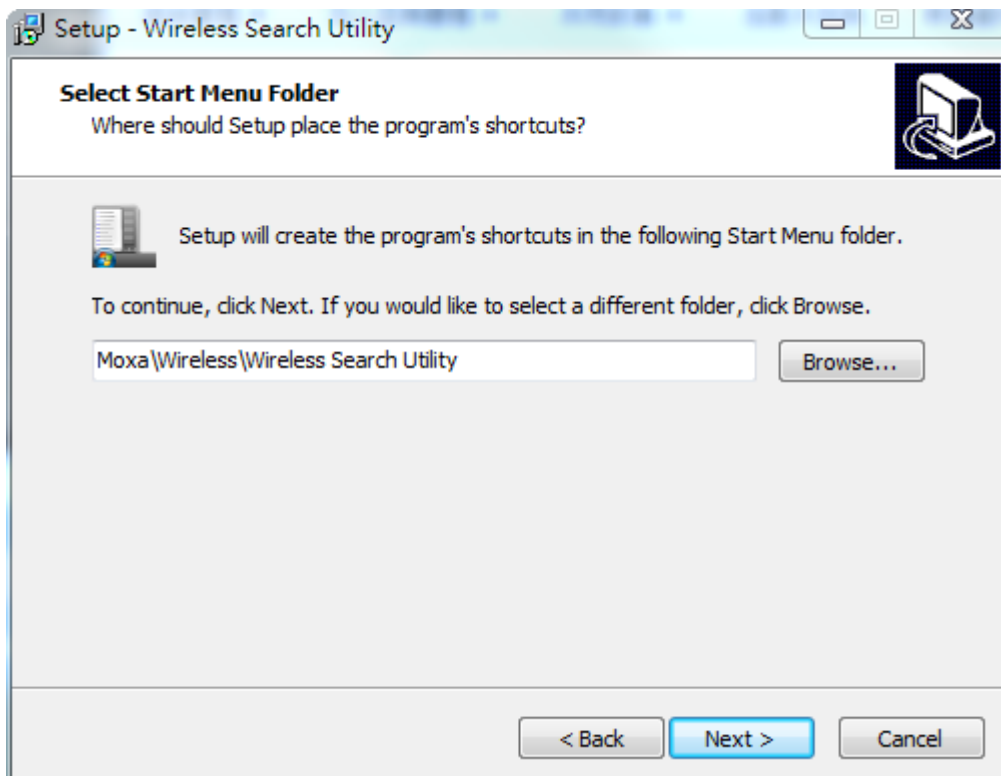

4. Click **Next** to select additional tasks.

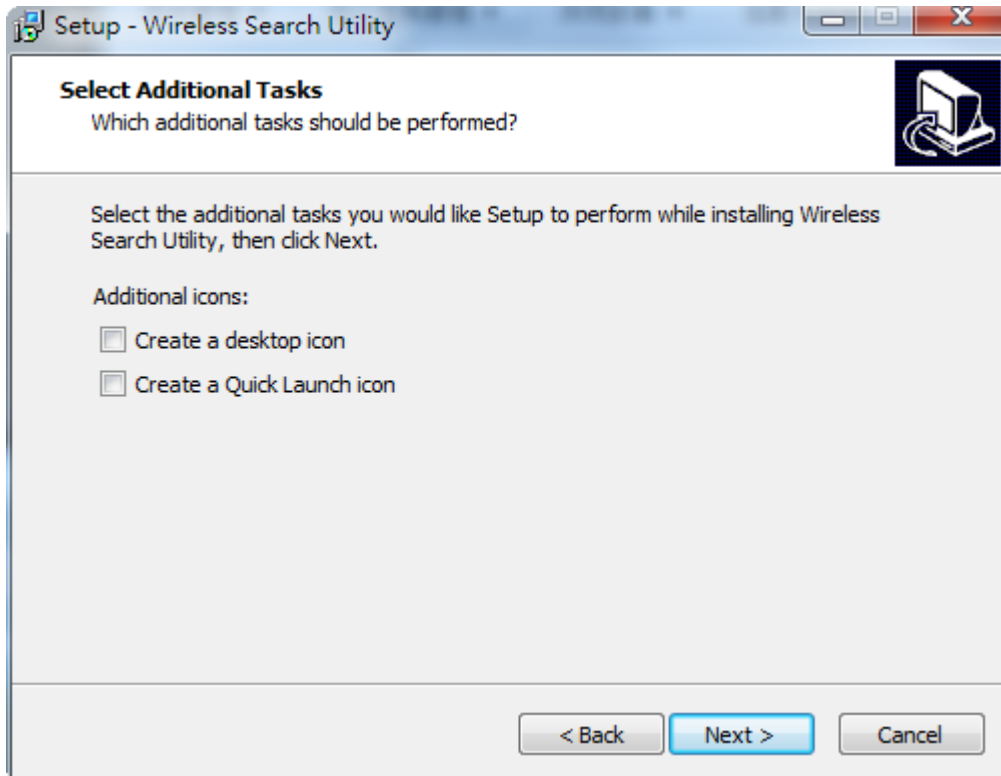

5. Click **Next** to proceed with the installation. The installer then displays a summary of the installation options.

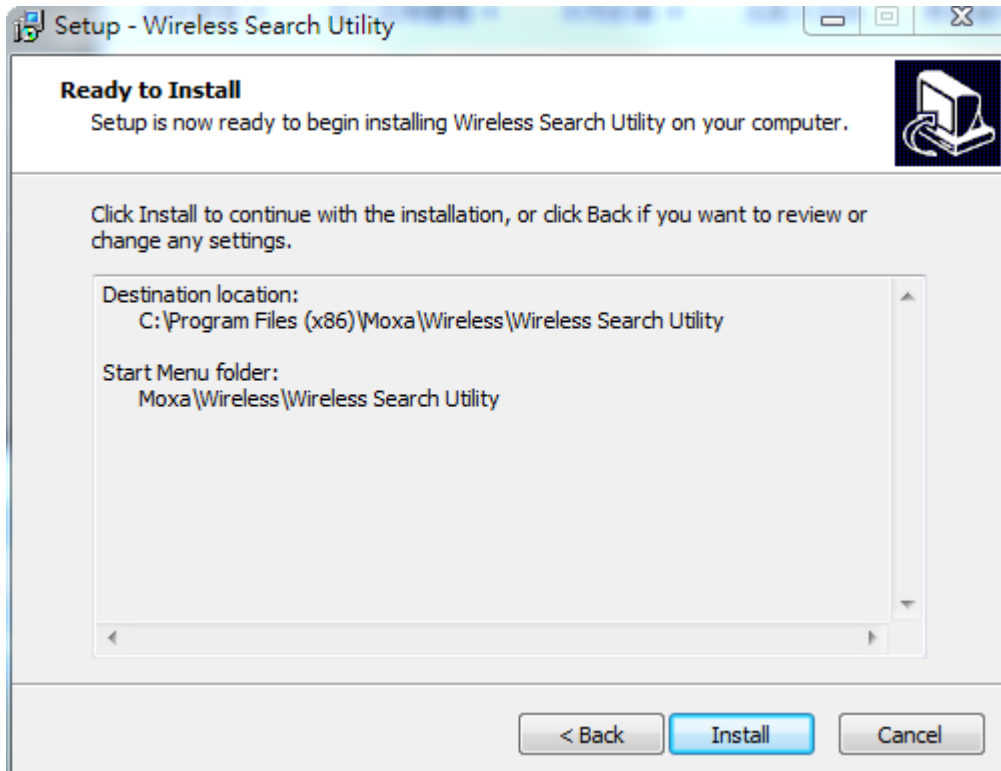

6. Click **Install** to begin the installation. The setup window will report the progress of the installation. To change the installation settings, click **Back** and navigate to the previous screen.

7. Click **Finish** to complete the installation of Wireless Search Utility.

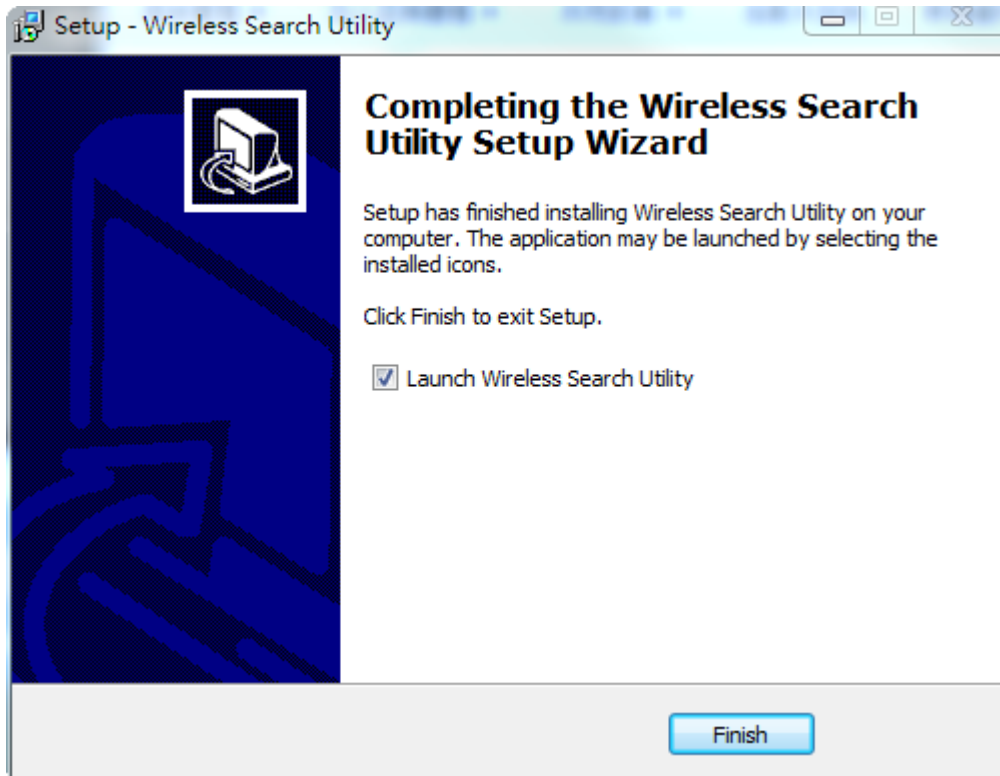

Configuring Wireless Search Utility

The Broadcast Search function is used to locate all AWK-3131A APs that are connected to the same LAN as your computer. After locating an AWK-3131A, you will be able to change its IP address. Since the Broadcast Search function searches by TCP packet and not IP address, it doesn't matter if the AWK-3131A is configured as an AP or Client. In either case, APs and Clients connected to the LAN will be located, regardless of whether or not they are part of the same subnet as the host.

1. Start the **Wireless Search Utility** program. When the Login page appears, select the "Device Search only" option to search for devices and to view the configuration of each device. Select the "Device management" option to assign IPs, upgrade firmware, and locate devices.

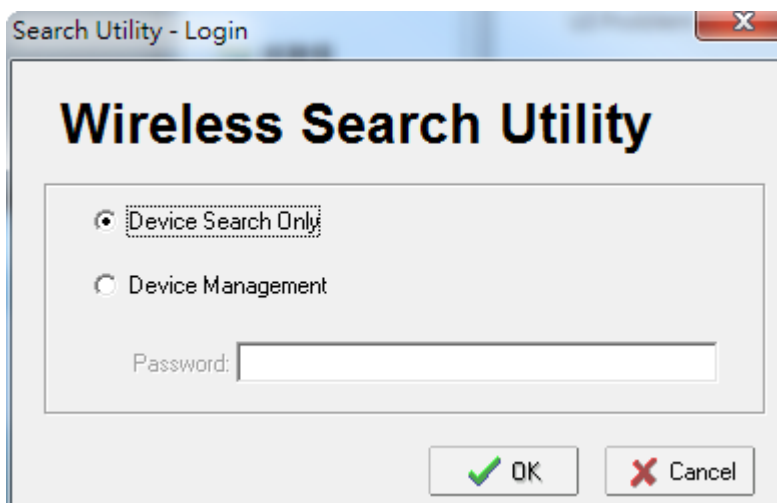

- Open the Wireless Search Utility and then click the **Search** icon.

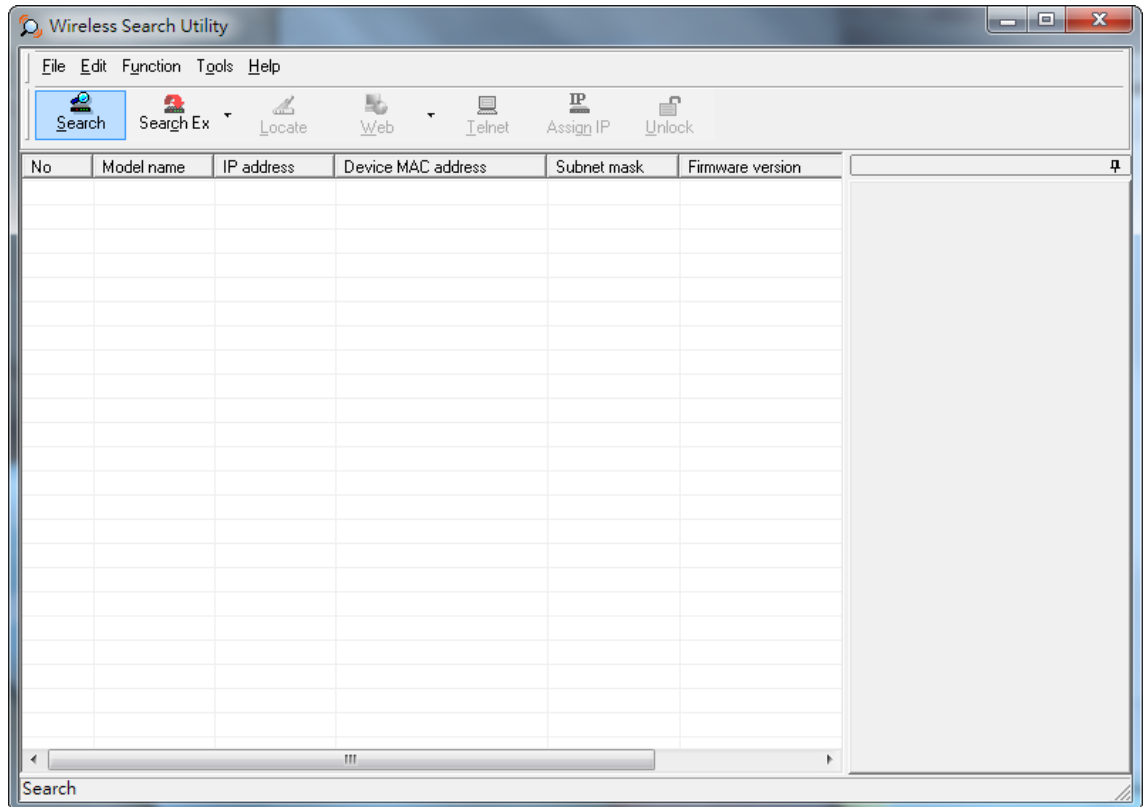

- The “Searching” window indicates the progress of the search. When the search is complete, all AWKs that were located will be displayed in the Wireless Search Utility window.

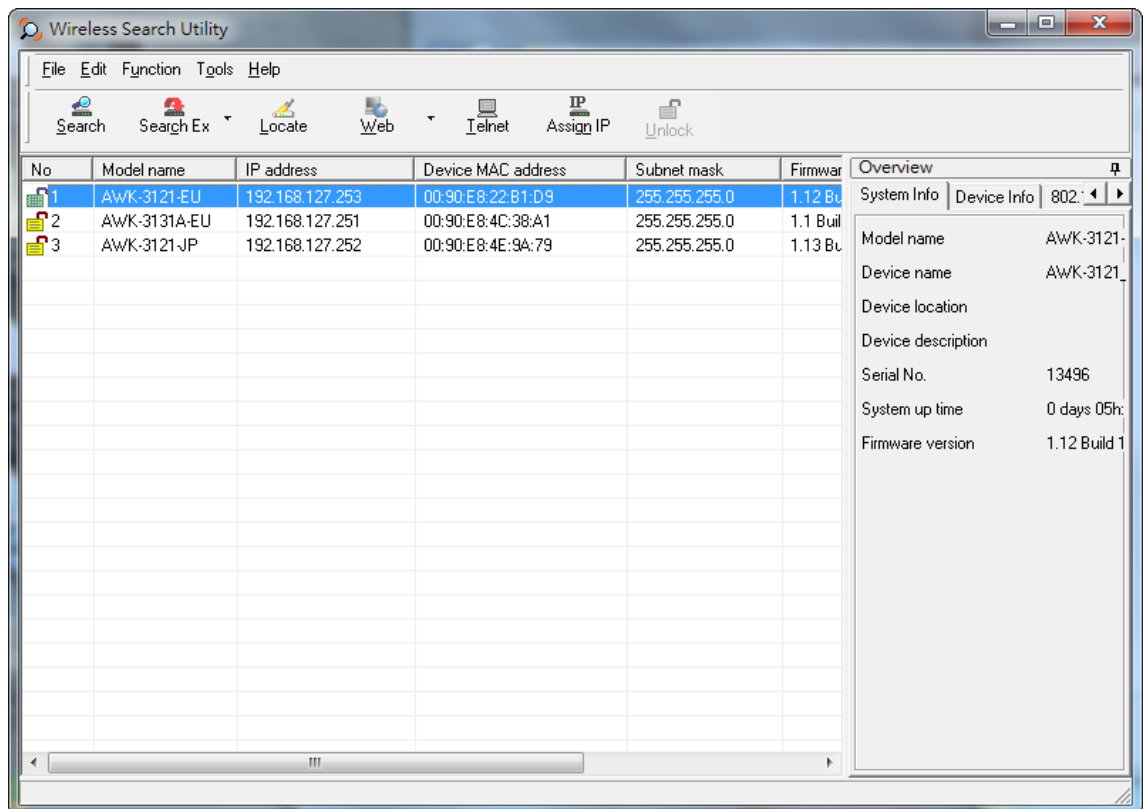

- Click **Locate** to cause the selected device to beep.

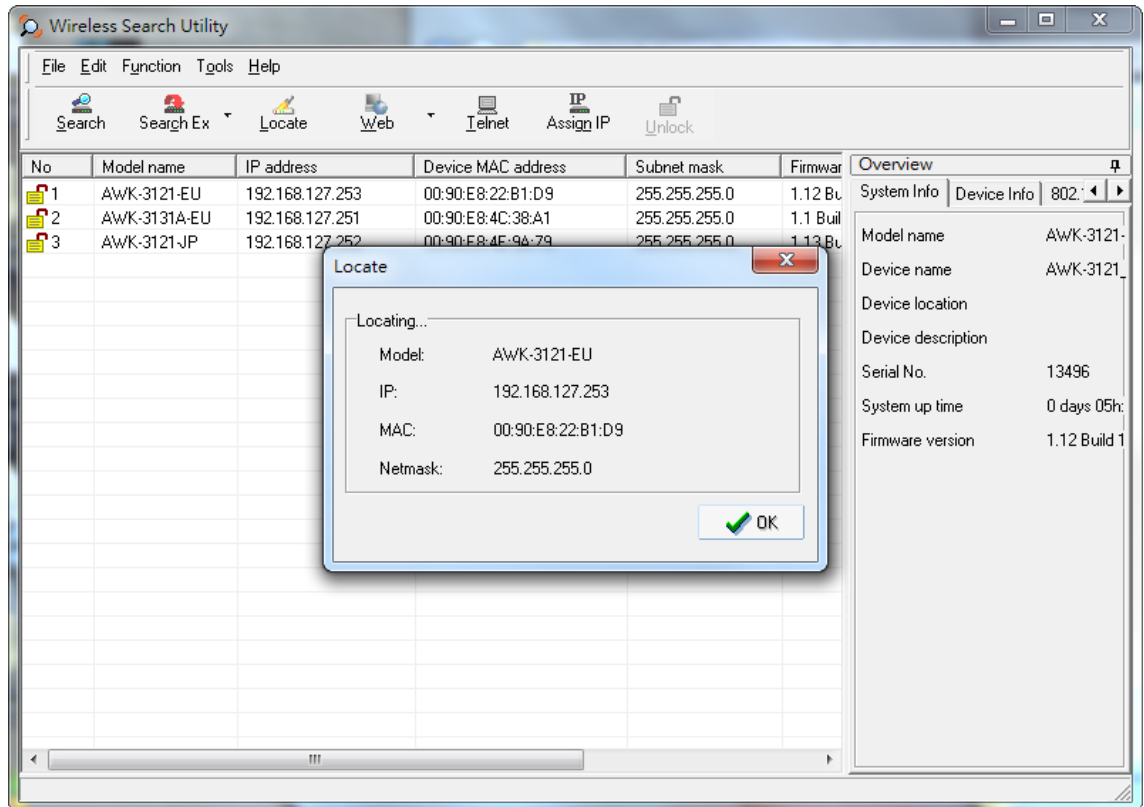

- Make sure your AWK is **unlocked** before using the search utility's icons setting. The AWK will unlock automatically if the password is set to the default. Otherwise you must enter the new password manually.
- Go to **Tools > Login Options** to manage and unlock additional AWKs.

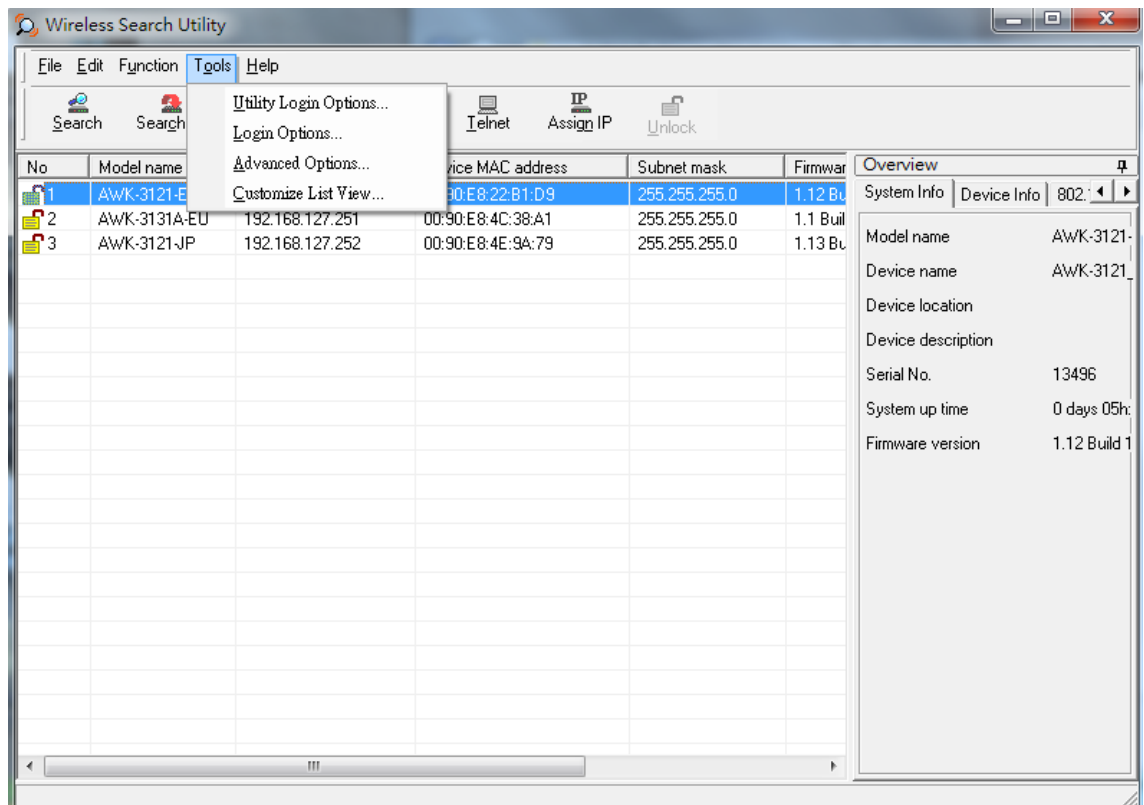

- Use the scroll down list to select the MAC addresses of those AWKs you would like to manage, and then click **Add**. Key in the password for the AWK device and then click **OK** to save. If you return to the search page and search for the AWK again, you will find that the AWK will unlock automatically.



ATTENTION

For security purposes, we suggest you can change the Wireless Search Utility login password instead of using the default.

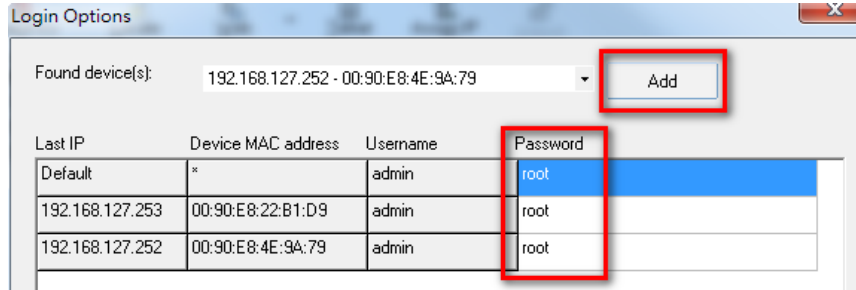

To modify the configuration of the highlighted AWK:

- Click on the Web icon to open the web console.

This will take you to the web console, where you can make all configuration changes. Refer to Chapter 3, "Using the Web Console," for information on how to use the web console.

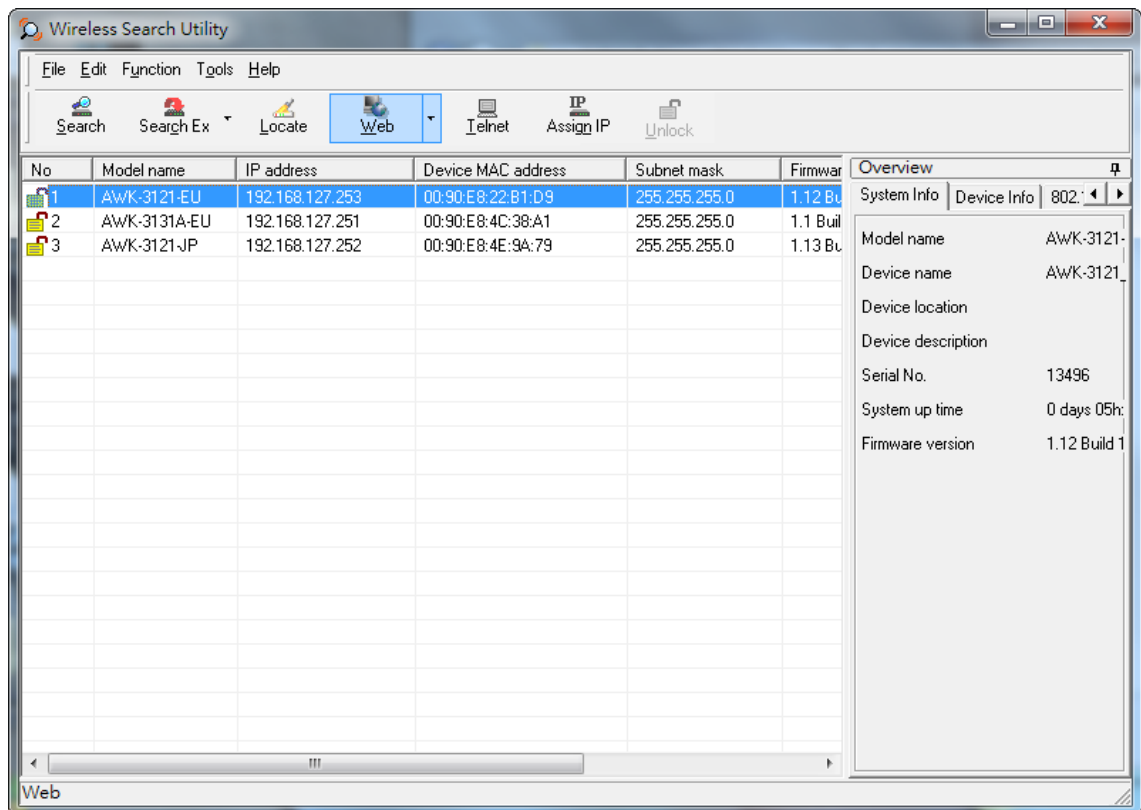

- Click on **Telnet** if you would like to use telnet to configure your AWKs.

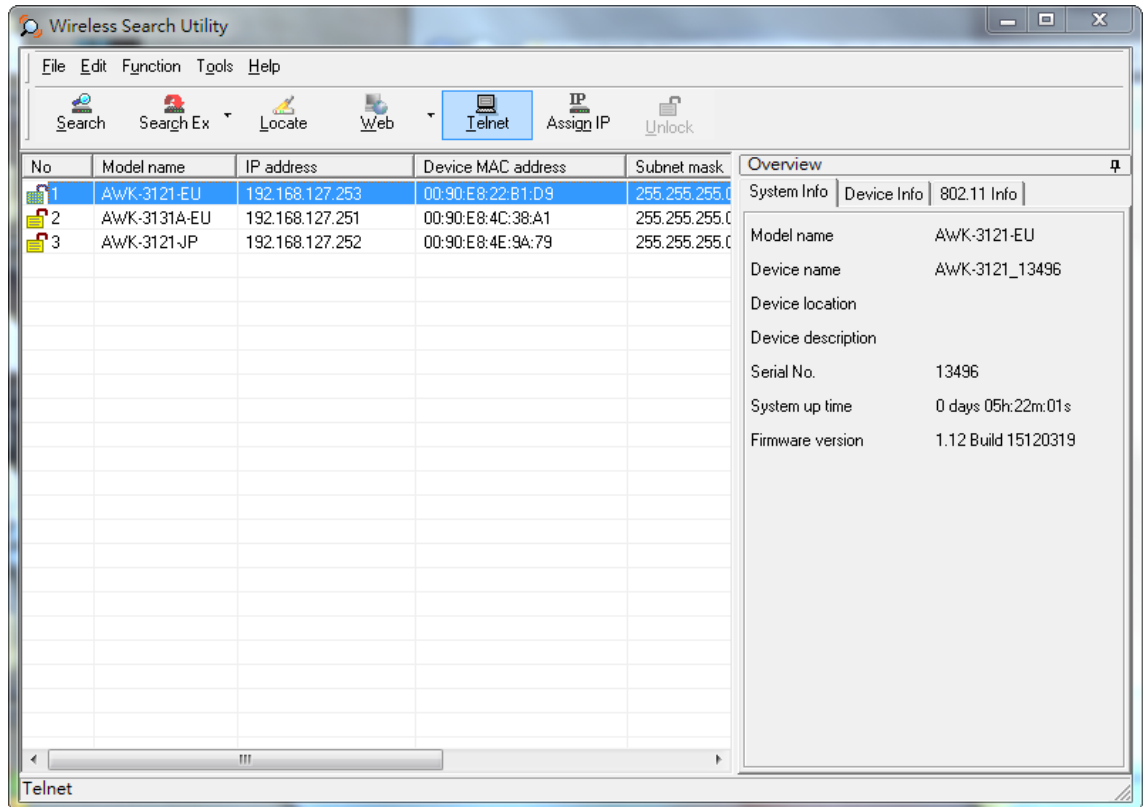

- Click **Assign IP** to change the IP setting.

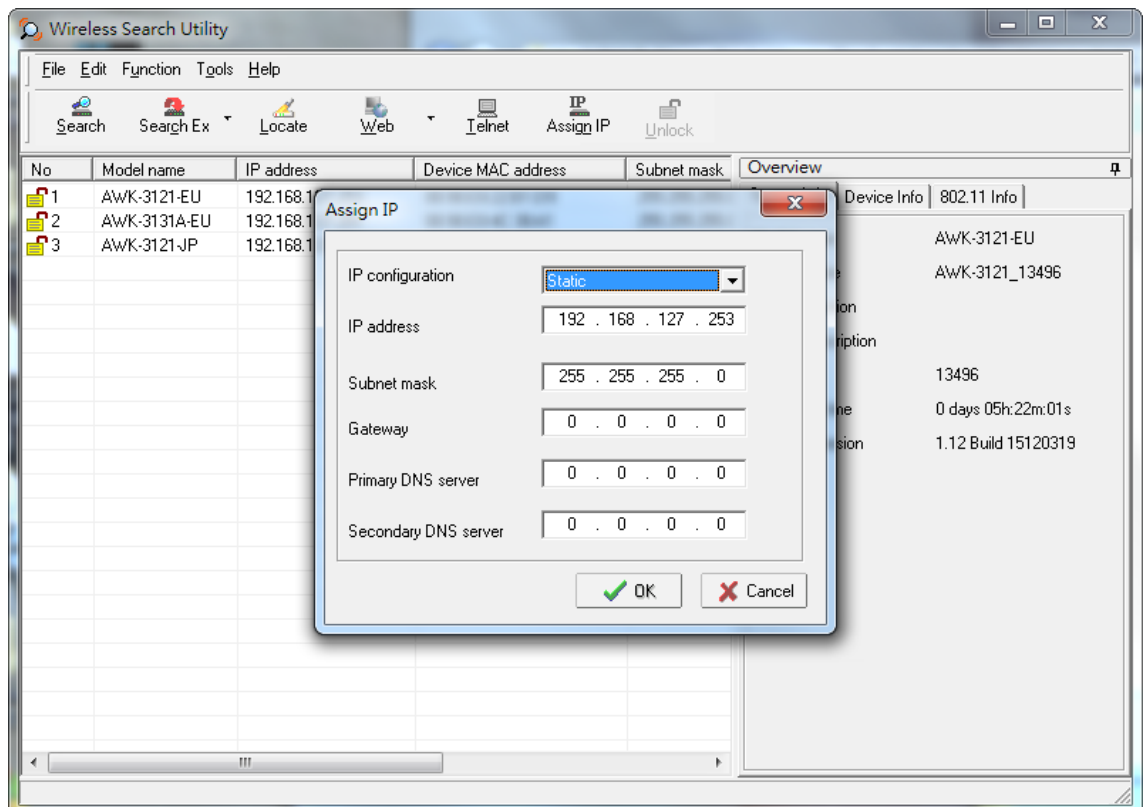

The three advanced options—**Search**, **Connection**, and **Miscellaneous**—are explained below:

Search

- **Retry count (default=5):** Indicates how many times the search will be retried automatically.
- **Retry interval (ms):** The time elapsed between retries.

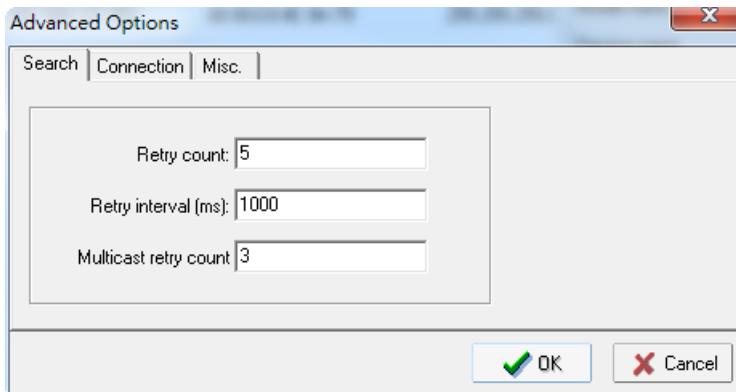

The screenshot shows the 'Advanced Options' dialog box with the 'Search' tab selected. It contains three input fields: 'Retry count' set to 5, 'Retry interval (ms)' set to 1000, and 'Multicast retry count' set to 3. At the bottom right, there are 'OK' and 'Cancel' buttons.

Connection

- **Connection timeout (secs):** Use this option to set the waiting time for the **Default Login, Locate, Assign IP, Upload Firmware, and Unlock** to complete.
- **Upgrade timeout (secs):** Use this option to set the waiting time for the connection to disconnect while the firmware is upgrading. Use this option to set the waiting time for the Firmware to write to flash.

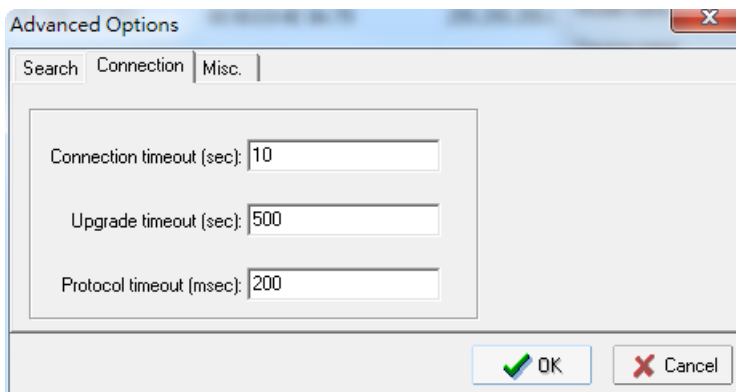

The screenshot shows the 'Advanced Options' dialog box with the 'Connection' tab selected. It contains three input fields: 'Connection timeout (sec)' set to 10, 'Upgrade timeout (sec)' set to 500, and 'Protocol timeout (msec)' set to 200. At the bottom right, there are 'OK' and 'Cancel' buttons.

Misc.

Search on start: Checkmark this box if you would like the search function to start searching for devices after you log in to the Wireless Search Utility.

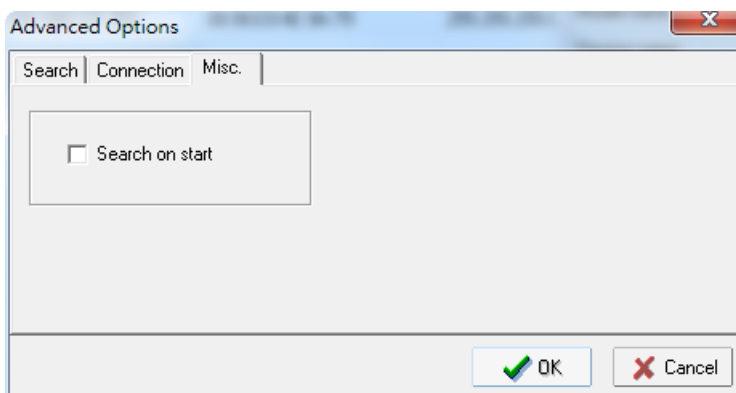

The screenshot shows the 'Advanced Options' dialog box with the 'Misc.' tab selected. It contains a single checkbox labeled 'Search on start', which is currently unchecked. At the bottom right, there are 'OK' and 'Cancel' buttons.

5. Using Other Consoles

This chapter explains how to access the AWK-3131A for the first time. In addition to HTTP access, there are four ways to access AWK-3131A: serial console, Telnet console, SSH console, and HTTPS console. The serial console connection method, which requires using a short serial cable to connect the AWK-3131A to a PC's COM port, can be used if you do not know the AWK-3131A's IP address. The other consoles can be used to access the AWK-3131A over an Ethernet LAN, or over the Internet.

RS-232 Console Configuration (115200, None, 8, 1, VT100)

The serial console connection method, which requires using a short serial cable to connect the AWK-3131A to a PC's COM port, can be used if you do not know the AWK-3131A's IP address. It is also convenient to use serial console configurations when you cannot access the AWK-3131A over Ethernet LAN, such as in the case of LAN cable disconnections or broadcast storming over the LAN.



ATTENTION

Do not use the RS-232 console manager when the AWK-3131A is powered at reversed voltage (ex. -48VDC), even though reverse voltage protection is supported.

If you need to connect the RS-232 console at reversed voltage, Moxa's TCC-82 isolator is your best solution.



NOTE

We recommend using **Moxa PComm (Lite)** Terminal Emulator, which can be downloaded free of charge from Moxa's website.

Before running PComm Terminal Emulator, use an RJ45 to DB9-F (or RJ45 to DB25-F) cable to connect the AWK-3131A's RS-232 console port to your PC's COM port (generally COM1 or COM2, depending on how your system is set up). After installing PComm Terminal Emulator, take the following steps to access the RS-232 console utility.

1. From the Windows desktop, open the Start menu and start **PComm Terminal Emulator** in the PComm (Lite) group.
2. Select Open under Port Manager to open a new connection.

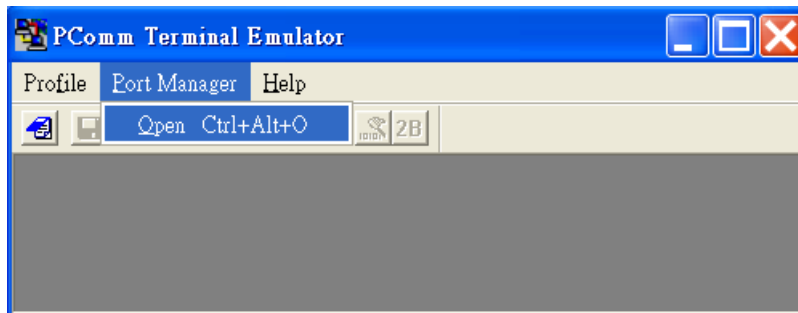

The **Communication Parameter** page of the Property window opens. Select the appropriate COM port for Console Connection, **115200** for Baud Rate, **8** for Data Bits, **None** for Parity, and **1** for Stop Bits. Click on the **Terminal** tab, and select **VT100 (or ANSI)** for Terminal Type. Click on **OK** to continue.

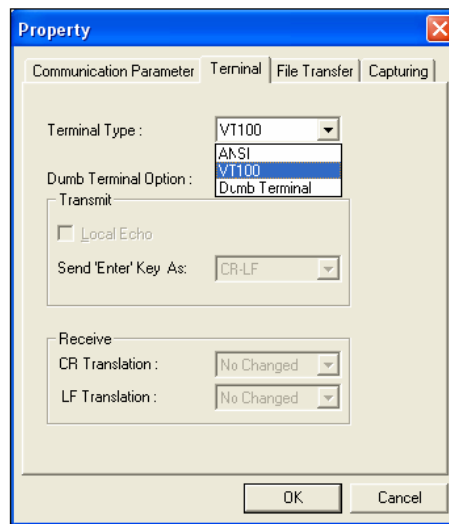
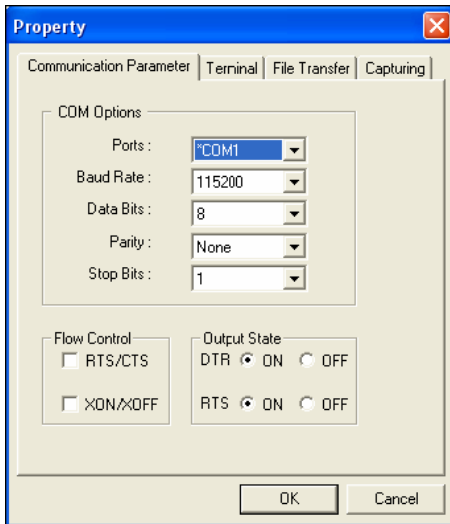

3. The Console login screen will appear. Log into the RS-232 console with the login name (default: **admin**) and password (default: **moxa**, if no new password is set).

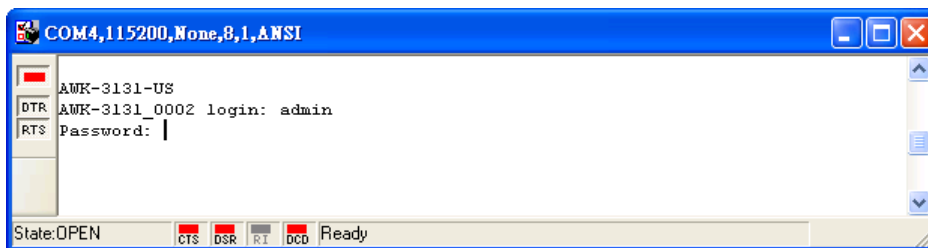

4. The AWK-3131A's device information and Main Menu will be displayed. Please follow the description on screen and select the administration option you wish to perform.

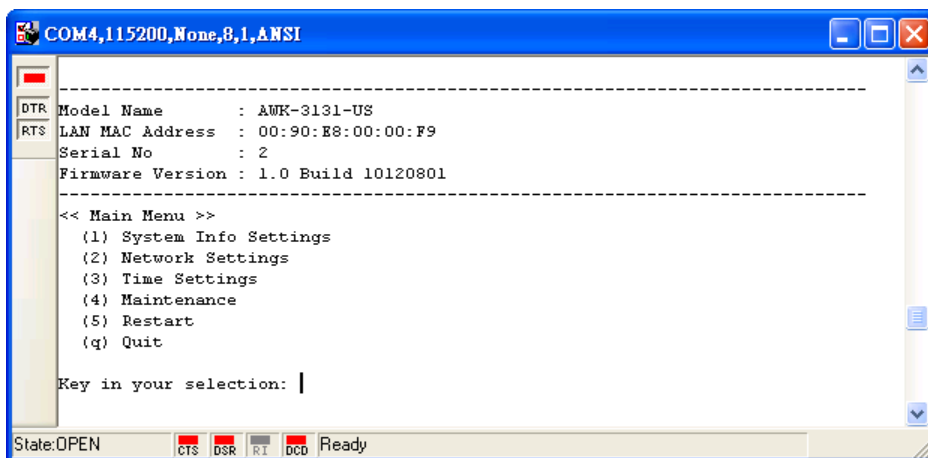

NOTE

To modify the appearance of the PComm Terminal Emulator window, select **Edit > Font** and then choose the desired formatting options.



ATTENTION

If you unplug the RS-232 cable or trigger **DTR**, a disconnection event will be evoked to enforce logout for network security. You will need to log in again to resume operation.

Configuration by Telnet and SSH Consoles

You may use Telnet or SSH client to access the AWK-3131A and manage the console over a network. To access the AWK-3131A's functions over the network from a PC host that is connected to the same LAN as the AWK-3131A, you need to make sure that the PC host and the AWK-3131A are on the same logical subnet. To do this, check your PC host's IP address and subnet mask.



NOTE

The AWK-3131A's default IP address is **192.168.127.253** and the default subnet mask is **255.255.255.0** (for a Class C network). If you do not set these values properly, please check the network settings of your PC host and then change the IP address to 192.168.127.xxx and subnet mask to 255.255.255.0.

Follow the steps below to access the console utility via Telnet or SSH client.

1. From Windows Desktop, run **Start > Run**, and then use Telnet to access the AWK-3131A's IP address from the Windows Run window (you may also issue the telnet command from the MS-DOS prompt).

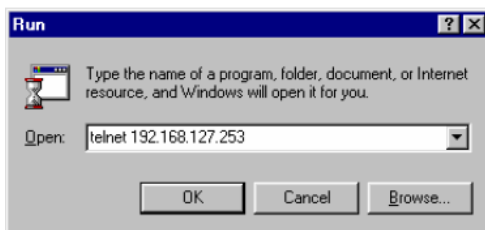

2. When using SSH client (ex. PuTTY), please run the client program (ex. putty.exe) and then input the AWK-3131A's IP address, specifying **22** for the SSH connection port.

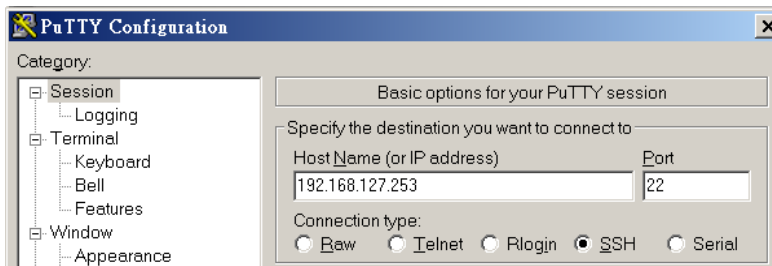

3. The Console login screen will appear. Please refer to the previous paragraph "RS-232 Console Configuration" and for login and administration.

Configuration by Web Browser with HTTPS/SSL

To secure your HTTP access, the AWK-3131A supports HTTPS/SSL encryption for all HTTP traffic. Perform the following steps to access the AWK-3131A's web browser interface via HTTPS/SSL.

1. Open your web browser and type `https://<AWK-3131A's IP address>` in the address field. Press **Enter** to establish the connection.

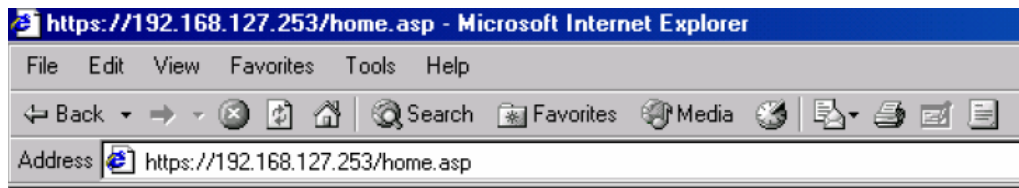

2. Warning messages will pop out to warn users that the security certificate was issued by a company they have not chosen to trust.

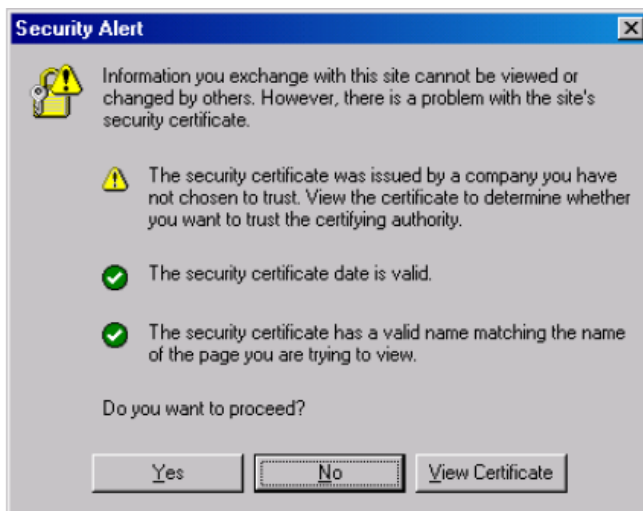

3. Select **Yes** to accept the certificate issued by Moxa IW and then enter the AWK-3131A's web browser interface secured via HTTPS/SSL. (You can see the protocol in URL is **https**.) Then you can use the menu tree on the left side of the window to open the function pages to access each of AWK-3131A's functions.

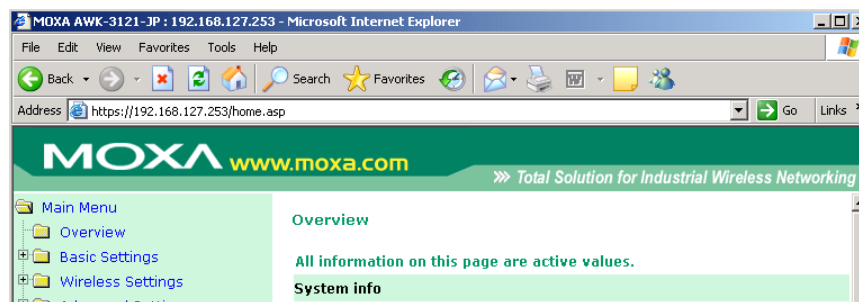

Disabling Telnet and Browser Access

If you are connecting the AWK-3131A to a public network but do not intend to use its management functions over the network, then we suggest disabling both Telnet Console and Web Configuration. Please run **Maintenance > Console Settings** to disable them, as shown in the following figure.

Console Settings	
HTTP console	<input checked="" type="radio"/> Enable <input type="radio"/> Disable
HTTPS console	<input checked="" type="radio"/> Enable <input type="radio"/> Disable
Telnet console	<input checked="" type="radio"/> Enable <input type="radio"/> Disable
SSH console	<input checked="" type="radio"/> Enable <input type="radio"/> Disable

A. References

This chapter provides more detailed information about wireless-related technologies. The information in this chapter can help you administer your AWK-3131As and plan your industrial wireless network better.

AeroLink Protection

In industrial applications, such as communication between off-shore oil platforms, or train-to-ground communications, a reliable wireless bridge is essential to minimize system downtime and maximize system availability. Moxa's AeroLink Protection provides a reliable wireless bridge between two networks to form network-level redundancy.

1. **Communication Failover:** AeroLink Protection members can negotiate with each other to automatically elect an Active node for data communication. If the Active node is no longer capable of sending data to its access point, it will inform other Backup nodes to resume the communication via another path.

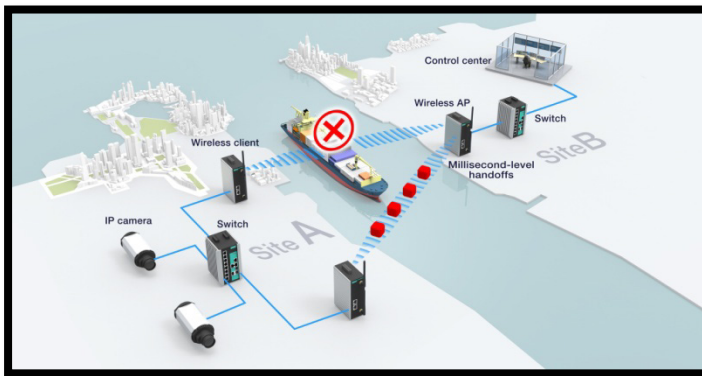

2. **Frequency-Interference Failover:** This concept is similar to the previous model. If the communication frequency experiences interference and data can no longer be transmitted over the Active frequency, it will resume the connection via another Backup frequency.

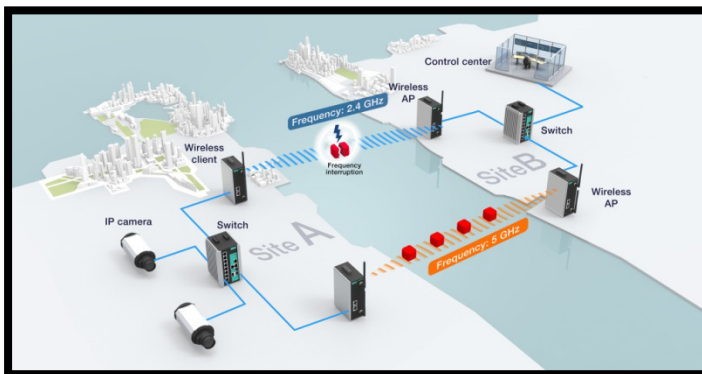

3. **Device Failover:** After covering the communication and frequency failures, in order to provide a single-point-of-failure free wireless network, AeroLink Protection also checks the device status. If the Active node has a power failure, the Backup nodes will automatically resume the wireless communication.

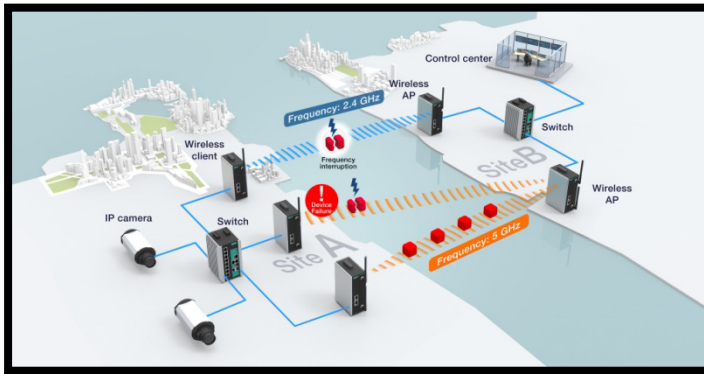

4. **Scalable:** AeroLink Protection is designed to allow scalable backup paths so that users can realize complete wireless redundancy from all of the above failure types by increasing the number of backup nodes.
5. **Fast Recovery:** In addition to maintaining a redundant wireless network, another key is providing uninterrupted communication even when a failure occurs. AeroLink protection is designed to restore communication from all failures with 300 ms.

A member of the AeroLink Protection group can take one of the following seven states:

- **Initiation State (Init):** Initiates the AeroLink Protection Protocol
- **Discovering State (Discover):** Discovers other AeroLink Protection members for further negotiation
- **Idle State (Idle):** Internal protocol checkpoint
- **Negotiation State (Nego):** Negotiates with other AeroLink Protection members and elects an Active node.
- **Backup State (Backup):** After negotiation, this node is assigned as a Backup node. All traffic will go through the Active node instead.



NOTE

When a node is in Backup state, the STATE LED will be blinking.

- **Active State (Active):** After negotiation, this node is assigned as Active node, which means that all traffic will go through this node.
- **Role Change State (Change):** If the Active node is no longer capable of data transmission via the WLAN, it will turn into Change State to trigger the re-negotiation of the Active node from the Backup nodes.

The AeroLink Protection function can adopt one of the following three detection methods:

- SNR: States the Signal-Noise Ratio (SNR) of the associated client.
- Signal Strength: States the Signal Strength of the associated client
- Disconnection

Wireless Distribution System (WDS)

Traditionally, APs are connected via Ethernet LAN ports. By using a Wireless Distribution System (WDS), APs can communicate with one another wirelessly. For example, AP 2 acts as an access point for the notebook computers or other IEEE 802.11-enabled clients, and forwards packets sent from the notebook computers to AP 1 through WDS. Then, AP 1 forwards the packets to the Ethernet LAN. Packets destined for the notebook computers follow a reverse path from the Ethernet LAN through the APs to the notebook computers. In this way, AP 2 acts as an "AP repeater."

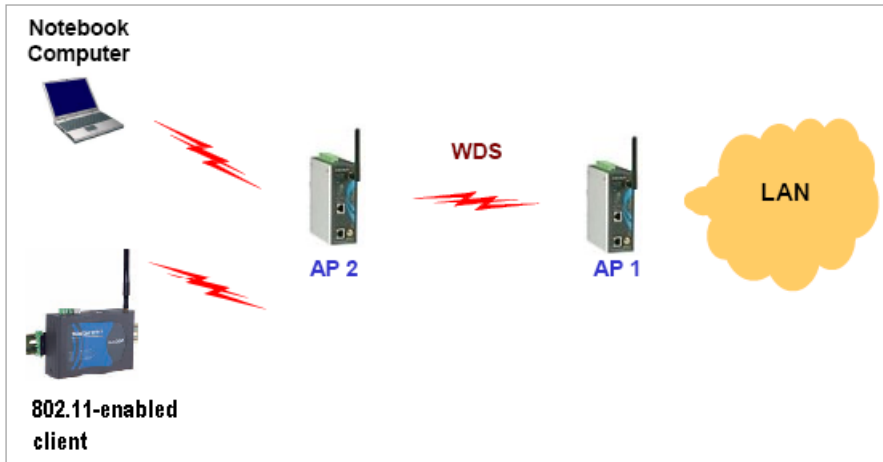

By using WDS, two or more LAN segments can be connected wirelessly. As illustrated in the figure below, a pair of wireless LAN-to-LAN bridges is used to connect two LAN segments. Since the AP is WDS-enabled, it can be used as a wireless bridge.

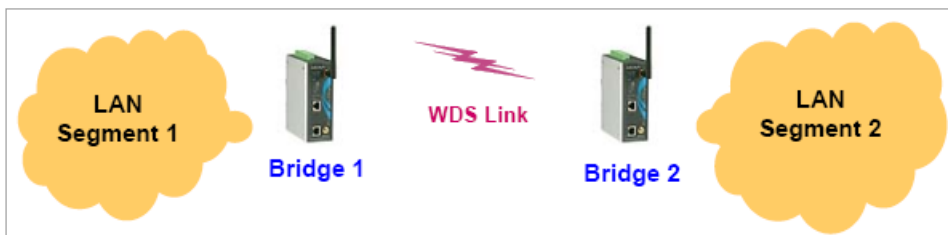

It is a good idea to plan your wireless network by drawing a diagram so that you know how each AWK-3131A is connected to other peer APs or wireless bridges by WDS, and how bridges are connected to other peer bridges by WDS. See the following figure for an example of a network-planning diagram.

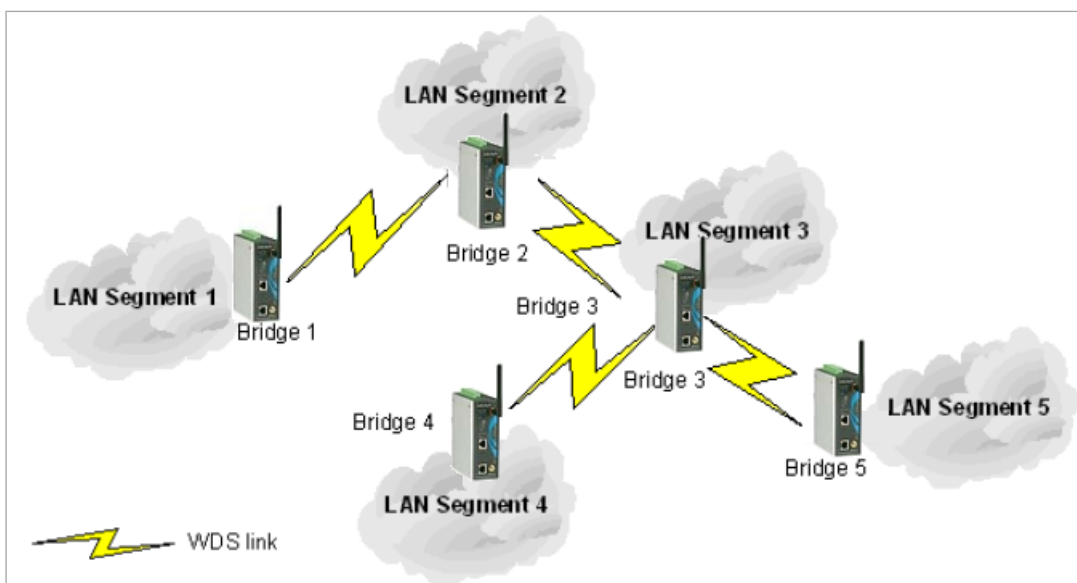



ATTENTION

Be sure to eliminate loops from networks that consist of wireless bridges, Ethernet switches, Ethernet links, and WDS links. If any loops exist, packets will circle around the loops and network performance will be seriously degraded. The following figure shows a network topology containing a loop.

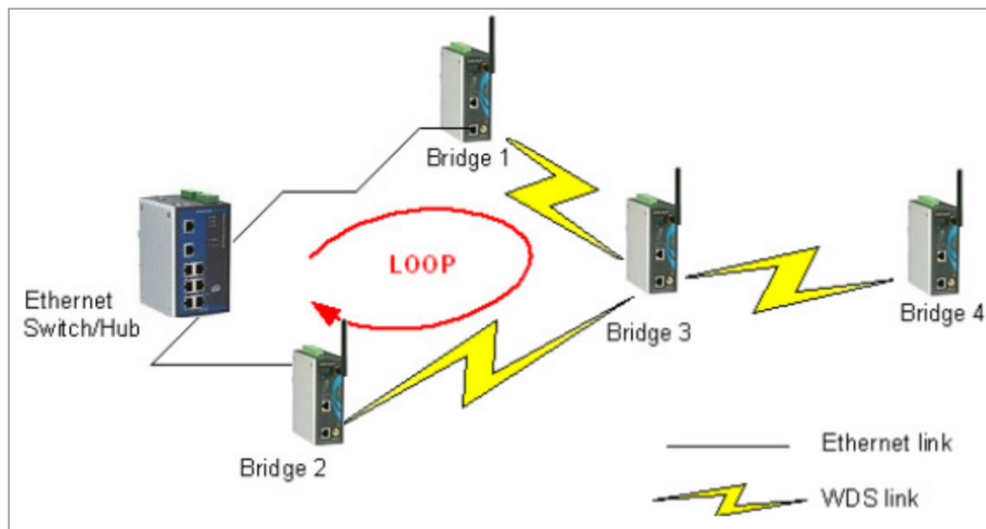

Beacon

A beacon is a packet broadcast by the AP to keep the network synchronized. A beacon includes the wireless LAN service area, the AP address, the Broadcast destination address, a time stamp, Delivery Traffic Indicator Maps (DTIM), and the Traffic Indicator Message (TIM). Beacon Interval indicates the frequency interval of AP.

DTIM

Delivery Traffic Indication Map (DTIM) is contained in beacon frames. It is used to indicate that broadcast and multicast frames buffered by the AP will be delivered shortly. Lower settings result in more efficient networking, while preventing your PC from dropping into power-saving sleep mode. Higher settings allow your PC to enter sleep mode, thus saving power.

Fragment

A lower setting means smaller packets, which will create more packets for each transmission. If you have decreased this value and experience high packet error rates, you can increase it again, but it will likely decrease overall network performance. Only minor modifications of this value are recommended.

RTS Threshold

RTS Threshold (256-2346) – This setting determines how large a packet can be before the Access Point coordinates transmission and reception to ensure efficient communication. This value should remain at its default setting of 2,346. When you encounter inconsistent data flow, only minor modifications are recommended.

STP and RSTP

The STP/RSTP Concept

Spanning Tree Protocol (STP) was designed to help reduce link failures in a network, and provide protection from loops. Networks that have a complicated architecture are prone to broadcast storms caused by unintended loops in the network. The STP protocol is part of the IEEE 802.1D standard, 1998 Edition bridge specification.

Rapid Spanning Tree Protocol (RSTP) implements the Spanning Tree Algorithm and Protocol defined by IEEE 802.1w-2001 standard. RSTP provides the following benefits:

- The topology of a bridged network will be determined much more quickly compared to STP.
- RSTP is backward compatible with STP, making it relatively easy to deploy. For example:
 - Defaults to sending 802.1D-style BPDUs if packets with this format are received.
 - STP (802.1D) and RSTP (802.1w) can operate on the LAN ports and WLAN ports (AP and WDS1-WDS8) of the same AWK-3131A.

This feature is particularly helpful when the AWK-3131A connects to older equipment, such as legacy switches.

Differences between RSTP and STP

RSTP is similar to STP, but includes additional information in the BPDUs that allow each bridge to confirm that it has taken action to prevent loops from forming when it decides to enable a link to a neighboring bridge. Adjacent bridges connected via point-to-point links will be able to enable a link without waiting to ensure that all other bridges in the network have had time to react to the change. The main benefit of RSTP is that the configuration decision is made locally rather than network-wide, allowing RSTP to carry out automatic configuration and restore a link faster than STP.

B. Supporting Information

This chapter presents additional information about this product. You can also learn how to contact Moxa for technical support.

Firmware Recovery

When the LEDs of **FAULT**, **Signal Strength** and **WLAN** all light up simultaneously and blink at one-second interval, it means the system booting has failed. It may result from some wrong operation or uncontrollable issues, such as an unexpected shutdown during firmware update. The AWK-3131A is designed to help administrators recover such damage and resume system operation rapidly. You can refer to the following instructions to recover the firmware:

Connect to the AWK-3131A's ES-232 console with **115200bps and N-8-1**. You will see the following message shown on the terminal emulator every one second.

```
please set-up TFTP server 192.168.127.1 contains awk3131a.rom for firmware
recovery.
please set-up TFTP server 192.168.127.1 contains awk3131a.rom for firmware
recovery.
please set-up TFTP server 192.168.127.1 contains awk3131a.rom for firmware
recovery.
please set-up TFTP server 192.168.127.1 contains awk3131a.rom for firmware
recovery.
please set-up TFTP server 192.168.127.1 contains awk3131a.rom for firmware
recovery.
please set-up TFTP server 192.168.127.1 contains awk3131a.rom for firmware
recovery.
```

Take the following steps for the firmware recovery:

1. Change the IP address of the laptop to 192.168.127.1.
2. Set up a TFTP sever on your laptop.
3. Download the AWK-3131A's firmware from Moxa's Website
4. Change the firmware file name to awk3131a.rom
5. Connect to the AWK-3131A's RJ45 Ethernet port

If the setting is correct, you will see the following message shown on the terminal emulator, and the AWK-3131A will reboot when the firmware recovery process has finished.

```
Trying eth0
Using eth0 device
TFTP from server 192.168.127.1; our IP address is 192.168.127.253
Filename 'awk3131a.rom'.
Load address: 0x80060000
Loading:
*#####
#####
#####
```

Declaration of Conformity

Federal Communication Commission Interference Statement

This equipment has been tested and found to comply with the limits for a Class B digital device, pursuant to Part 15 of the FCC Rules. These limits are designed to provide reasonable protection against harmful interference in a residential installation. This equipment generates, uses and can radiate radio frequency energy and, if not installed and used in accordance with the instructions, may cause harmful interference to radio communications. However, there is no guarantee that interference will not occur in a particular installation. If this equipment does cause harmful interference to radio or television reception, which can be determined by turning the equipment off and on, the user is encouraged to try to correct the interference by one of the following measures:

- Reorient or relocate the receiving antenna.
- Increase the separation between the equipment and receiver.
- Connect the equipment into an outlet on a circuit different from that to which the receiver is connected.
- Consult the dealer or an experienced radio/TV technician for help.

FCC Caution: To assure continued compliance, (example – use only shielded interface cables when connecting to computer or peripheral devices). Any changes or modifications not expressly approved by the party responsible for compliance could void the user's authority to operate this equipment. This transmitter must not be co-located or operated in conjunction with any other antenna or transmitter.

FCC Radiation Exposure Statement

This equipment complies with FCC radiation exposure limits set forth for an uncontrolled environment. This equipment should be installed and operated with a minimum distance of 20 cm between the radiator and your body.

This device complies with Part 15 of the FCC Rules. Operation is subject to the following two conditions: (1) This device may not cause harmful interference, and (2) this device must accept any interference received, including interference that may cause undesired operation.

Within the 5.15-5.25 GHz band, U-NII devices will be restricted to indoor operations to reduce any potential for harmful interference to co-channel MSS operations.

RED Compliance Statement

Moxa declares that the apparatus AWK-3131A complies with the essential requirements and other relevant provisions of Directive 2014/53/Eu.

The 5150 to 5350 MHz frequency range is restricted to indoor use only. Outdoor operation in this range is strictly prohibited.

Safety

This equipment is designed with the utmost care for the safety of those who install and use it. However, special attention must be paid to the dangers of electric shock and static electricity when working with electrical equipment. All guidelines of this and of the computer manufacturer must therefore be allowed at all times to ensure the safe use of the equipment.

EU Countries Not Intended for Use

None.