

V2201 Series Hardware User's Manual

Edition 2.0, February 2017

www.moxa.com/product

MOXA[®]

© 2017 Moxa Inc., All rights reserved.

V2201 Series Hardware User's Manual

The software described in this manual is furnished under a license agreement and may be used only in accordance with the terms of that agreement.

Copyright Notice

© 2017 Moxa Inc., All rights reserved.

Trademarks

The MOXA logo is a registered trademark of Moxa Inc.
All other trademarks or registered marks in this manual belong to their respective manufacturers.

Disclaimer

Information in this document is subject to change without notice and does not represent a commitment on the part of Moxa.

Moxa provides this document as is, without warranty of any kind, either expressed or implied, including, but not limited to, its particular purpose. Moxa reserves the right to make improvements and/or changes to this manual, or to the products and/or the programs described in this manual, at any time.

Information provided in this manual is intended to be accurate and reliable. However, Moxa assumes no responsibility for its use, or for any infringements on the rights of third parties that may result from its use.

This product might include unintentional technical or typographical errors. Changes are periodically made to the information herein to correct such errors, and these changes are incorporated into new editions of the publication.

Technical Support Contact Information

www.moxa.com/support

Moxa Americas

Toll-free: 1-888-669-2872
Tel: +1-714-528-6777
Fax: +1-714-528-6778

Moxa Europe

Tel: +49-89-3 70 03 99-0
Fax: +49-89-3 70 03 99-99

Moxa India

Tel: +91-80-4172-9088
Fax: +91-80-4132-1045

Moxa China (Shanghai office)

Toll-free: 800-820-5036
Tel: +86-21-5258-9955
Fax: +86-21-5258-5505

Moxa Asia-Pacific

Tel: +886-2-8919-1230
Fax: +886-2-8919-1231

Table of Contents

1. Introduction	1-1
Package Checklist	1-2
Product Features	1-2
V2201 Hardware Specifications	1-2
Hardware Block Diagram	1-5
2. Hardware Introduction	2-1
Appearance	2-2
Dimensions (unit = mm)	2-3
LED Indicators	2-4
Reset Button	2-4
3. Hardware Connection Description	3-1
Installing the V2201	3-2
Wiring Requirements	3-4
Connecting the Power	3-4
Grounding the Unit	3-4
Connecting Data Transmission Cables	3-5
Installing the Wireless Modules	3-5
Connecting to the Network	3-7
Connecting to a Serial Device	3-9
Installing an SDHC/SDXC Card	3-9
Connecting to a USB Device	3-10
DI/DO	3-10
Connecting to an HDMI Monitor	3-11
RTC Battery Replacement	3-12
4. BIOS Setup	4-1
Entering the BIOS Setup	4-2
Main Information	4-3
Advanced Settings	4-3
Boot Configuration	4-4
PCI Express Configuration	4-4
USB Configuration	4-5
SD Configuration	4-6
Miscellaneous Configuration	4-7
SATA Configuration	4-8
Console Redirection	4-9
Hardware Monitor	4-10
SMART RECOVERY Info	4-10
Security Settings	4-11
Set Supervisor Password	4-11
Power Settings	4-12
Wake on LAN	4-12
Auto Wake on S5	4-12
Boot Settings	4-14
Boot Type	4-14
PXE Boot to LAN	4-14
PXE Boot capability	4-14
Add Boot Options	4-14
USB Boot	4-15
Boot Delay Time	4-15
Automatic Failover	4-15
Boot Order Priority	4-15
Legacy	4-15
EFI	4-16
Exit Settings	4-16
Exit Saving Changes	4-17
Save Change Without Exit	4-17
Exit Discarding Changes	4-17
Load Optimal Defaults	4-17
Load Custom Defaults	4-17
Save Custom Defaults	4-17
Discard Changes	4-17
Upgrading the BIOS	4-18
A. Regulatory Approval Statement	A-1

Introduction

Moxa's V2201 ultra-compact x86 embedded computers are based on the Intel® Atom™ E3800 series processor, feature the most reliable I/O design to maximize connectivity, and support dual wireless modules, making them suitable for a diverse range of communication applications. The computers' thermal design ensures reliable operation in temperatures ranging from -40 to 85°C (-40 to 70°C for wireless operation with a special-purpose Moxa wireless module installed). The V2201 series supports "Moxa Hardware Monitoring" for device I/O status monitoring and alerts, system temperature monitoring and alerts, and system power management. Monitoring system status closely makes it easier to recover from errors and provides the most reliable platform for your applications.

The following topics are covered in this chapter:

- ❑ **Package Checklist**
- ❑ **Product Features**
- ❑ **V2201 Hardware Specifications**
- ❑ **Hardware Block Diagram**

Package Checklist

Each model is shipped with the following items:

- V2201 embedded computer
- Terminal block to power jack converter
- Wall mounting kit
- Documentation and software CD or DVD
- Quick installation guide (printed)
- Warranty card

NOTE: Please notify your sales representative if any of the above items are missing or damaged.

Product Features

V2201 embedded computers support the following features:

- Intel Atom E3800 series processor with three performance options
- -40 to 85°C system operating temperature (-40 to 70°C with LTE module installed)
- Dual mini-PCIe sockets for wireless modules: WiFi, 3G, LTE, GPS, and Bluetooth
- Variety of interfaces: 2 serial ports, 2 Ethernet LAN ports, 4 DIs, 4 DOs, SD, USB, HDMI, wireless
- EN 61000-6-2 and EN 61000-6-4 certification*; meets EMC standard for heavy industry
- Up to 5 Grms anti-vibration and 100 G anti-shock
- Ready-to-run Debian 7, Windows Embedded Standard 7 platforms
- Moxa Proactive Monitoring utility for system hardware health monitoring
- Moxa SmartRecovery utility to recover system from boot failure (W7E only)

*Passed with AC/DC adapter.

V2201 Hardware Specifications

Computer

CPU:

V2201-E1 Series: Intel® Atom™ Processor E3815 (Single Core, 512K Cache, 1.46 GHz)

V2201-E2 Series: Intel® Atom™ Processor E3826 (Dual Core, 1M Cache, 1.46 GHz)

V2201-E4 Series: Intel® Atom™ Processor E3845 (Quad Core, 1M Cache, 1.91 GHz)

OS: Windows Embedded Standard 7 64-bit or Linux Debian 7 64-bit

System Memory: 1 DDR3 SO-DIMM slot, 8 GB max.

- E3815 and E3826 support DDR3L-1066
- E3845 supports DDR3L-1333

USB: 1 bootable USB 3.0 port, 2 bootable USB 2.0 ports (type A)

Storage

mSATA: 1 internal mini-PCIe socket for OS storage

SD: 1 SD 3.0 (SDHC/SDXC) socket for storage expansion*

*W7E only supports SD 2.0

Audio

Output: Line-out interface (together with HDMI)

Other Peripherals

Expansion Slot: 2 Mini-PCIe sockets

- 1 USB signal, for Sierra Wireless 3G/LTE module
- 1 USB + PCIe signal

USIM: 1 USIM slot

Display

Graphics Controller: Intel® HD (integrated)

Connector Type: 1 HDMI connector (type A)

Display Interface: Supports HDMI 1.4a, 1920 x 1080 pixels @ 60/24 bpp

Ethernet Interface

LAN: 2 auto-sensing 10/100/1000 Mbps ports (RJ45)

Isolation Protection: 1.5 kV

Wireless SMA Interface

Wi-Fi: 2 SMA connectors

3G/LTE: 2 SMA connectors

GPS: 1 SMA connector

Serial Interface

Serial Standards: 2 RS-232/422/485 ports, software selectable (DB9 male)

Serial Communication Parameters

Data Bits: 5, 6, 7, 8

Stop Bits: 1, 1.5, 2

Parity: None, Even, Odd, Space, Mark

Flow Control: RTS/CTS, XON/XOFF, ADDC® (automatic data direction control) for RS-485

Baudrate: 50 bps to 115.2 kbps (non-standard baudrates supported; see user's manual for details)

Serial Signals

RS-232: TxD, RxD, DTR, DSR, RTS, CTS, DCD, GND

RS-422: TxD+, TxD-, RxD+, RxD-, GND

RS-485-4w: TxD+, TxD-, RxD+, RxD-, GND

RS-485-2w: Data+, Data-, GND

Digital Input

Input Channels: 4, source type

Input Voltage: 0 to 30 VDC at 25 Hz

Digital Input Levels for Dry Contacts:

Logic level 0: Close to GND

Logic level 1: Open

Digital Input Levels for Wet Contacts:

Logic level 1: +3 V max

Logic level 0: +10 V to +30 V (Source to DI)

Connector Type: 10-pin screw-fastened Euroblock terminal

Isolation: 3 kV optical isolation

Digital Output

Output Channels: 4, sink type

Output Current: Max. 200 mA per channel

On-state Voltage: 24 VDC nominal, open collector to 30 VDC

Connector Type: 10-pin screw-fastened Euroblock terminal

Isolation: 3 kV optical isolation

LEDs

System: Power, user-defined

Storage: mSATA, SD

LAN: 2 LEDs per port (10/100/1000 Mbps)

Serial: 2 LEDs per port (Tx and Rx)

Wireless: Wireless 1, Wireless 2

Switches and Buttons

Power Switch: on/off (left-side panel)

Reset Button: For warm reboot (left-side panel)

Physical Characteristics

Housing: Aluminum

Weight: 940 g

Dimensions:

Without ears: 150 x 48.8 x 120.2 mm (5.91 x 1.92 x 4.73 in)

With ears: 178 x 52.5 x 120.2 mm (7.01 x 2.07 x 4.73 in)

Mounting: DIN rail, wallmount

Environmental Limits

Operating Temperature:

- E1/E2 models: -40 to 85°C (-40 to 185°F)
- E4 models: -40 to 70°C (-40 to 158°F)
- E1-W/E2-W/E4-W models with Moxa recommended wireless modules (3G/LTE + Wi-Fi) installed: -40 to 70°C (-40 to 158°F)

Storage Temperature: -40 to 85°C (-40 to 185°F)

Ambient Relative Humidity: 5 to 95% (non-condensing)

Anti-Vibration: 5 Grms, 5 Hz to 500 Hz, 1 hr/axis w/ mSATA, SD

Anti-Shock: 100 g/11ms $\pm X$, $\pm Y$, $\pm Z$, 3 shocks each axis w/ mSATA, SD

Power Requirements

Input Voltage: 9 to 36 VDC (3-pin terminal block for V+, V-, SG)

Power Consumption: 18 W (2 A @ 9 VDC)

Standards and Certifications

Safety: UL 60950-1, CSA C22.2 No. 60950-1-03 (60950-1-07), EN 60950-1, CCC, UL 508

EMC: EN 55032 Class A, EN 61000-3-2 Class D, EN 61000-3-3, EN 55024, FCC Part 15 Subpart B Class A, EN 61000-6-2*, EN 61000-6-4*

Green Product: RoHS, CRoHS, WEEE

*Passed with AC/DC adapter

Reliability

Automatic Reboot Trigger: Software-programmable watchdog timer configurable from 1 to 255 seconds

Warranty

Warranty Period: 3 years

Details: See www.moxa.com/warranty

Note: These hardware specifications describe the embedded computer unit itself, but not its official accessories. In particular, the wide temperature specification does not apply to accessories such as power adapters and cables.

Hardware Block Diagram

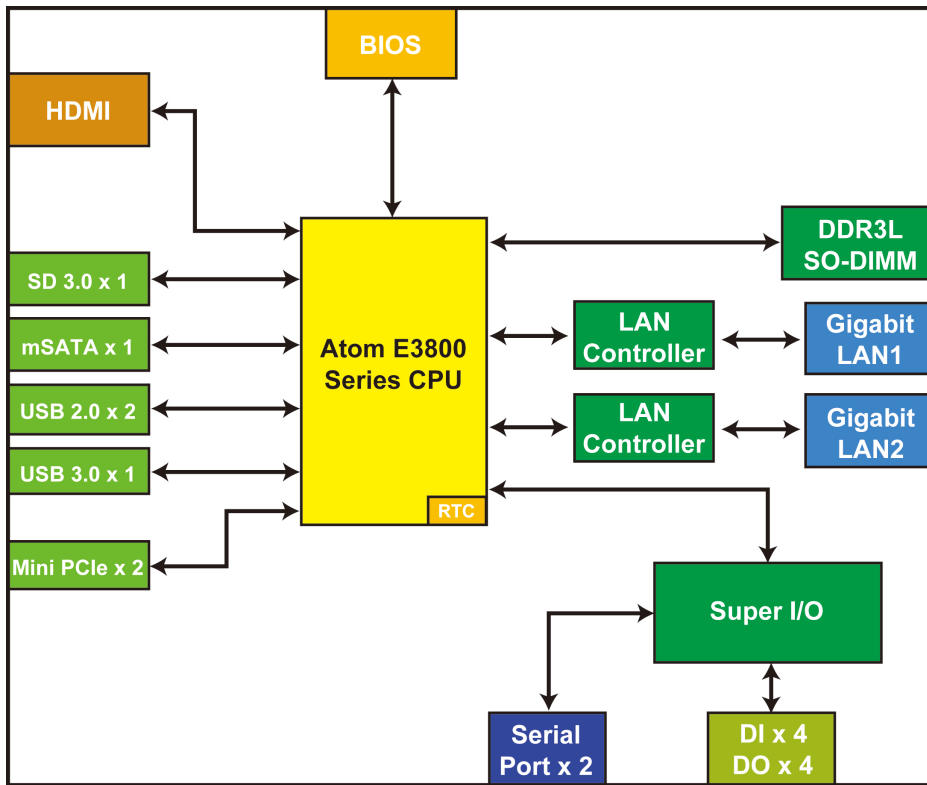

Hardware Introduction

The V2201 series embedded computers are compact, well-designed, and rugged enough for industrial applications. LED indicators help you monitor performance and identify trouble spots, multiple serial ports allow you to connect different devices for wireless operation, and the reliable and stable hardware platform lets you devote your attention to developing your applications.

The following topics are covered in this chapter:

- **Appearance**
- **Dimensions (unit = mm)**
- **LED Indicators**
- **Reset Button**

Appearance

Front View

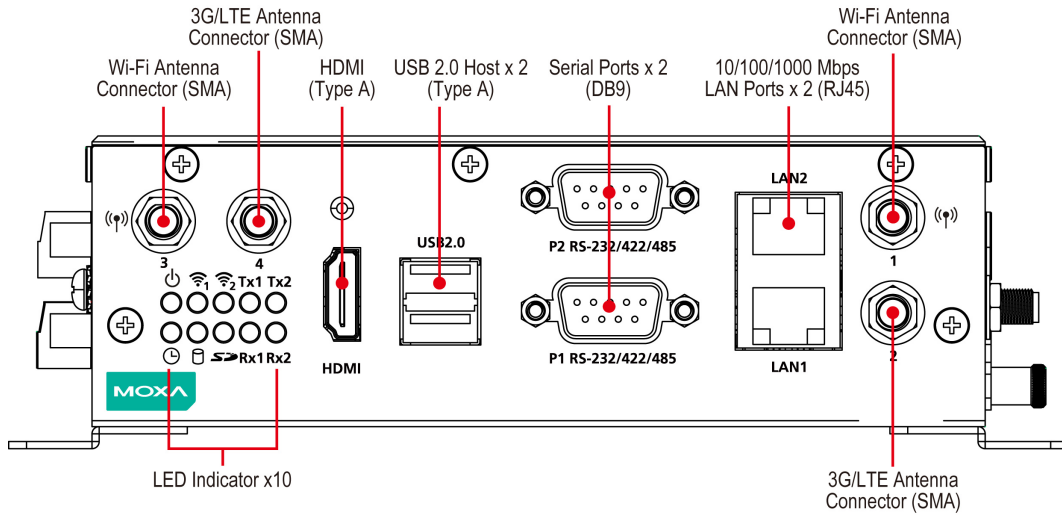

Right Side View

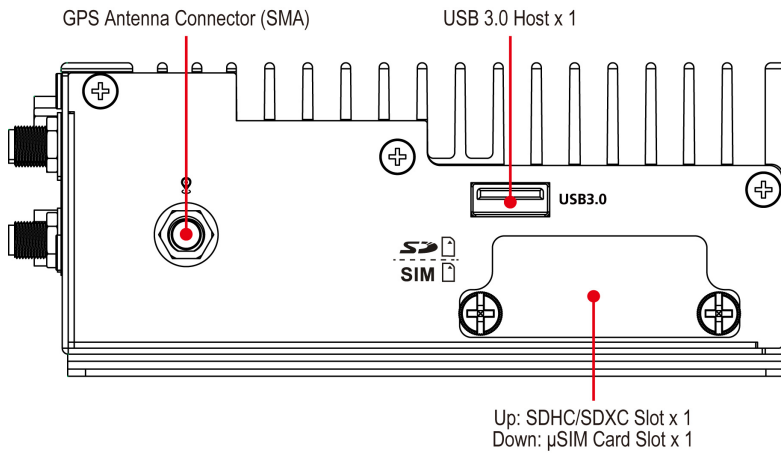

Left Side View

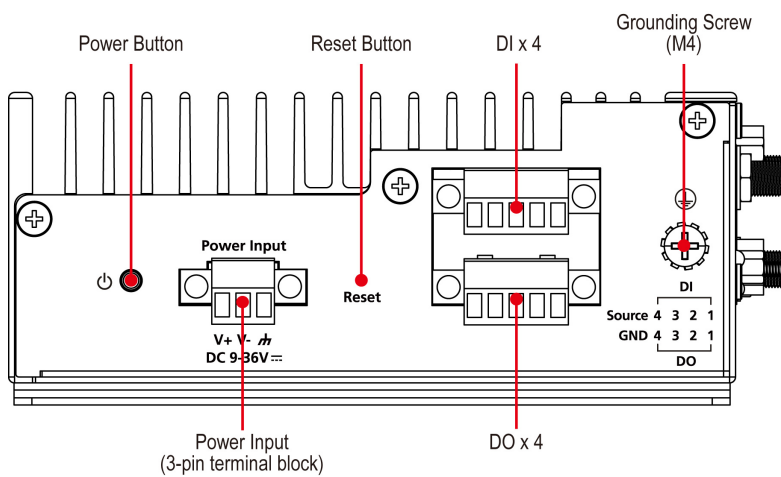

Dimensions (unit = mm)

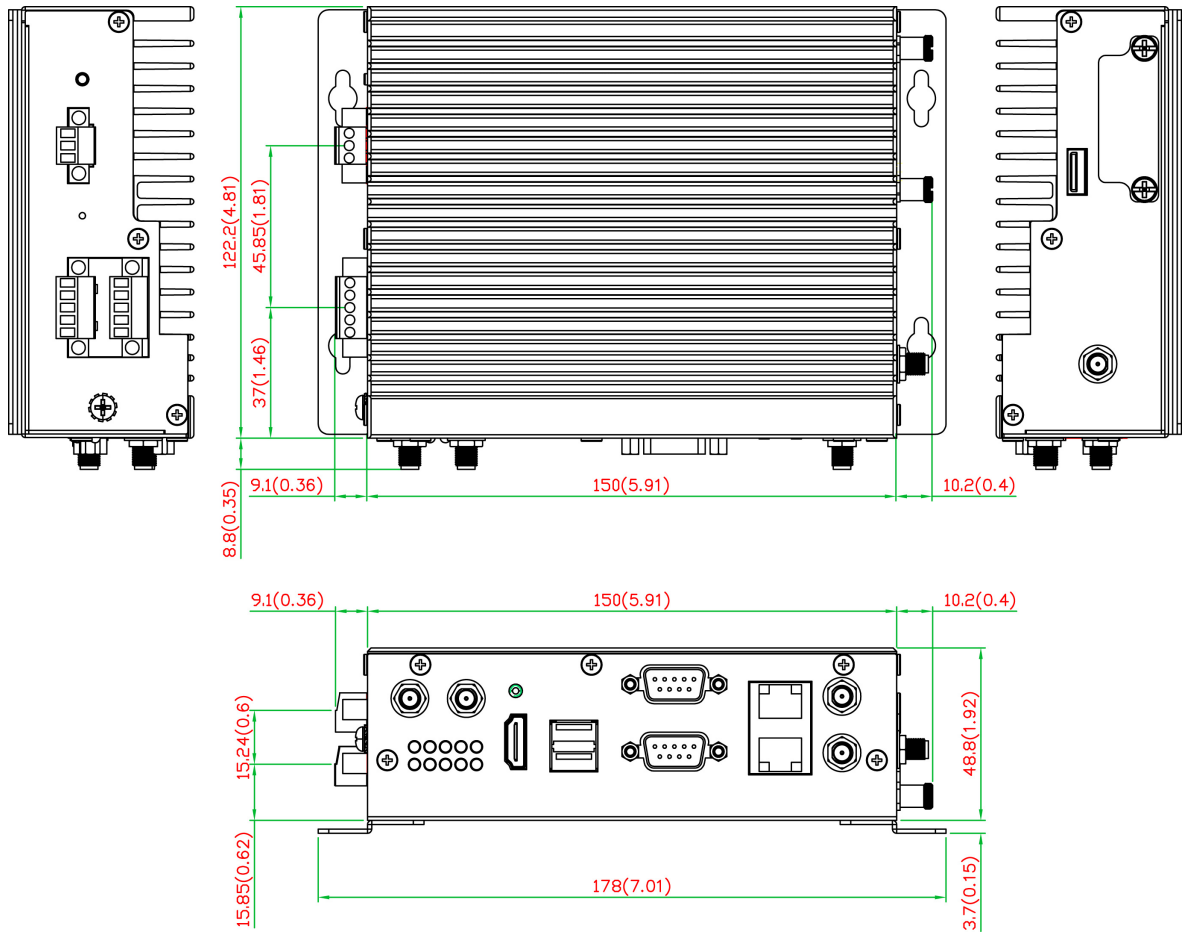

LED Indicators

LED Name	Status	Function
Power	Green	Power is on and computer is functioning normally.
	Off	Power is off
User Defined	Red	Event has occurred
	Off	No alert
mSATA	Yellow	Blinking: Data is being transmitted
	Off	Not connected / No data transmission
SD Card	Yellow	Blinking: Data is being transmitted
	Off	Not connected / No data transmission
Wireless 1	Green	Steady On: Link is On Blinking: Data is being transmitted
	Off	Not connected
Wireless 2	Green	Steady On: Link is On Blinking: Data is being transmitted
	Off	Not connected
LAN 1	Yellow	Steady On: 1000 Mbps Ethernet link Blinking: Data is being transmitted
	Green	Steady On: 100 Mbps Ethernet link Blinking: Data is being transmitted
	Off	10 Mbps Ethernet link or LAN is not connected
LAN 2	Yellow	Steady On: 1000 Mbps Ethernet link Blinking: Data is being transmitted
	Green	Steady On: 100 Mbps Ethernet link Blinking: Data is being transmitted
	Off	10 Mbps Ethernet link or LAN is not connected
Tx 1	Green	Blinking: Data is being transmitted
	Off	Not connected
Tx 2	Green	Blinking: Data is being transmitted
	Off	Not connected
Rx 1	Yellow	Blinking: Data is being transmitted
	Off	Not connected
Rx 2	Yellow	Blinking: Data is being transmitted
	Off	Not connected

Reset Button

Press the "Reset Button" on the left side panel of the V2201 to reboot the system automatically.

Hardware Connection Description

In this chapter, we show how to connect the embedded computers to the network and to various devices.

The following topics are covered in this chapter:

- ❑ **Installing the V2201**
- ❑ **Wiring Requirements**
 - Connecting the Power
 - Grounding the Unit
- ❑ **Connecting Data Transmission Cables**
 - Installing the Wireless Modules
 - Connecting to the Network
 - Connecting to a Serial Device
 - Installing an SDHC/SDXC Card
- ❑ **Connecting to a USB Device**
- ❑ **DI/DO**
- ❑ **Connecting to an HDMI Monitor**
- ❑ **RTC Battery Replacement**

Installing the V2201

Wall or Cabinet Mounting

The V2201 comes with two metal brackets for attaching it to a wall or the inside of a cabinet.

Step 1: Use two screws for each bracket and attach the brackets to the rear of the V2201.

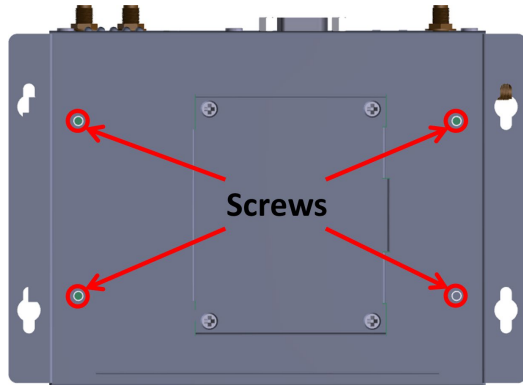

Step 2: Use four screws per side to attach the V2201 to a wall or cabinet.

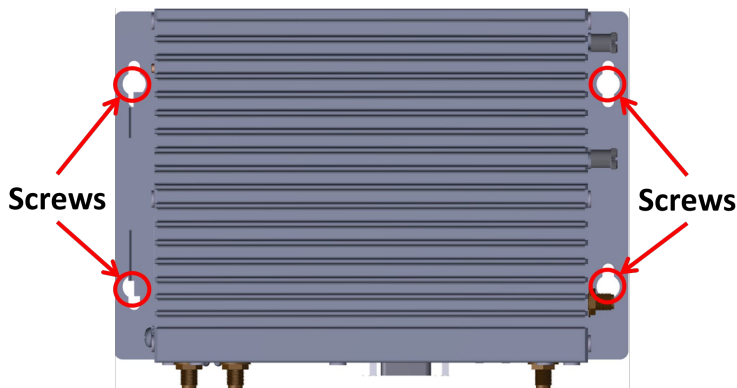

Din-Rail Mounting

The V2201 can be installed on a DIN-rail with the optional DIN-rail kit. This DIN-rail kit must be purchased separately. The DIN-rail kit includes one DIN-rail bracket and four screws.



The DK-DC50131 die-cast metal kit must be purchased separately. The kit is easy to install and makes the operation of the V2201 more robust. To install the DIN-rail mounting kit, use 4 screws to tightly attach the DIN-rail mounting bracket to the V2201's side panel.

NOTE Use all four screws to ensure that the V2201 is safely and securely installed on the DIN rail.

Installation:

STEP 1:

Insert the upper lip of the DIN rail into the DIN-rail mounting kit.

STEP 2:

Press the V2201 towards the DIN-rail until it snaps into place.

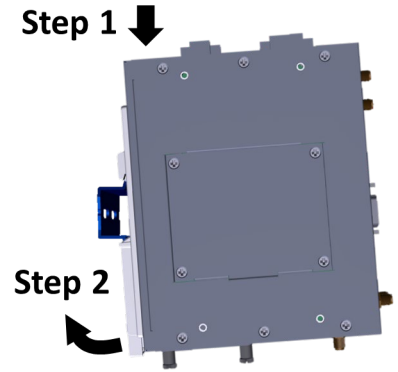

Removal:

STEP 1:

Pull down the latch on the mounting kit with a screwdriver.

STEPS 2 & 3:

Slightly pull the V2201 forward and lift up to remove it from the DIN-rail.

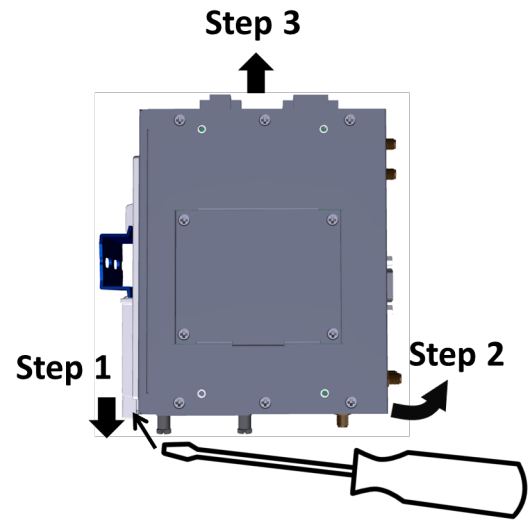

STEP 4:

Press the recessed button on the spring-loaded bracket to lock it into position for next use.

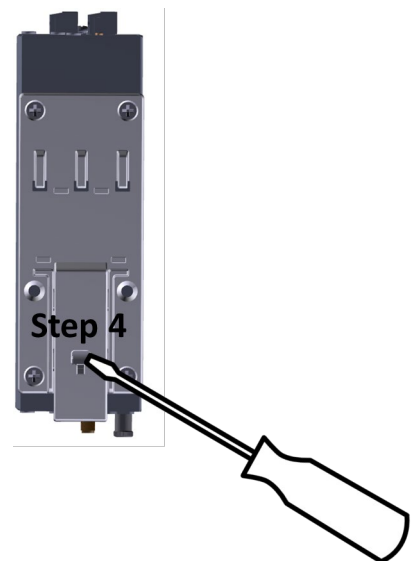

Wiring Requirements

In this section, we describe how to connect serial devices to the V2201 embedded computer.

Be sure to read and follow these common safety precautions before proceeding with the installation of any electronic device:

- Use separate paths to route wiring for power and devices. If power wiring and device wiring paths must cross, make sure the wires are perpendicular at the intersection point.
NOTE: Do not run signal or communication wiring together with power wiring in the same wire conduit. To avoid interference, wires with different signal characteristics should be routed separately.
- Use the type of signal transmitted through a wire to determine which wires should be kept separate. The rule of thumb is that wiring that shares similar electrical characteristics can be bundled together.
- Keep input wiring and output wiring separate.
- It is advisable to label the wiring to all devices in the system.



ATTENTION

Safety First!

Be sure to disconnect the power cord before installing and/or wiring your V2201.

Wiring Caution!

Calculate the maximum possible current in each power wire and common wire. Observe all electrical codes dictating the maximum current allowable for each wire size. If the current goes above the maximum ratings, the wiring could overheat, causing serious damage to your equipment.

Temperature Caution!

Be careful when handling the unit. When the unit is plugged in, the internal components generate heat, and consequently the outer casing may feel hot to the touch.

Connecting the Power

To power on the V2201, connect the “terminal block to power jack converter” to the V2201’s DC terminal block (located on the left side panel), and then connect the power adapter. The system is automatically turned on by default when the power is plugged in. If it doesn’t turn on automatically, press the Power Button to turn on the computer. Note that the Shielded Ground wire should be connected to the top pin of the terminal block. It takes about 30 seconds for the system to boot up. Once the system is ready, the Power LED will light up.

Grounding the Unit

Grounding and wire routing help limit the effects of noise due to electromagnetic interference (EMI). Run the ground connection from the grounding screw (M4) to the grounding surface prior to connecting the power.

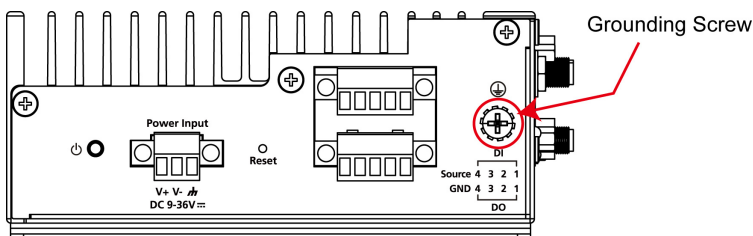

ATTENTION

This product is intended to be mounted to a well-grounded mounting surface, such as a metal panel.

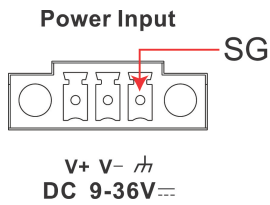

SG: The Shielded Ground (sometimes called Protected Ground) contact is the right most of the 3-pin power terminal block connector when viewed from the angle shown here. Connect the SG wire to an appropriate grounded metal surface.

Connecting Data Transmission Cables

In this section, we describe how to connect the V2201 embedded computer to a network and serial devices.

Installing the Wireless Modules



ATTENTION

V2201 series “-W” models (e.g., V2201-E2-W-T) include a cellular card heat sink and 5 x wireless SMA connectors, which are installed during the production process.

The V2201 features two mini-PCIe sockets on the bottom panel. One socket supports USB signals only using MC9090, MC7354, or MC7354 mini-PCIe cards. The other socket supports standard USB + PCIe signals.

STEP1: Loosen the four screws in the middle of the bottom panel and open the bottom cover.

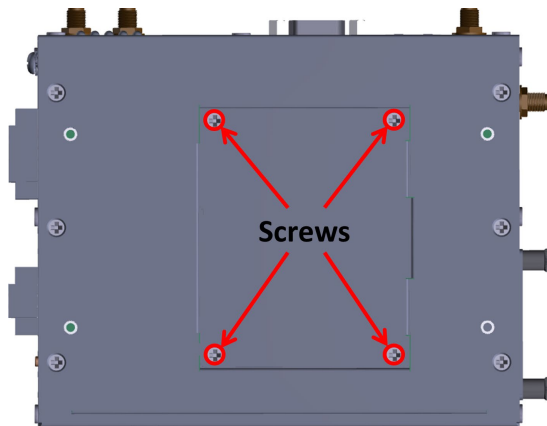

There are two mini-PCIe sockets:

Socket 1: USB signal, for 3G/LTE mini-PCIe card (Sierra Wireless MC9090, MC7304, MC7354).

NOTE Cellular card heat sink is installed in socket 1.

Socket 2: Standard USB + PCIe signal, for Wi-Fi mini-PCIe cards.

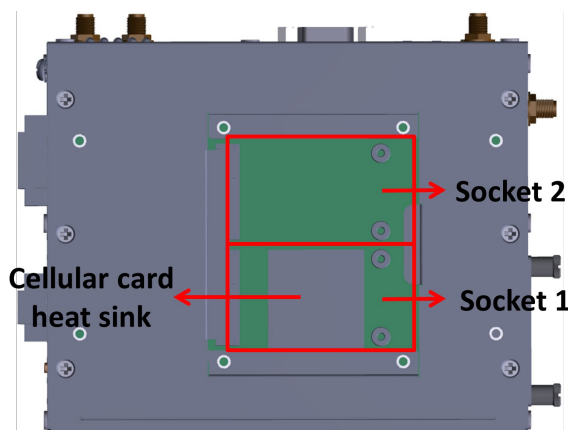

STEP 2: Insert the wireless module card at an angle.

STEP 3: Push down the wireless module card and then use the 2 screws included in the package to attach it to the V2201.

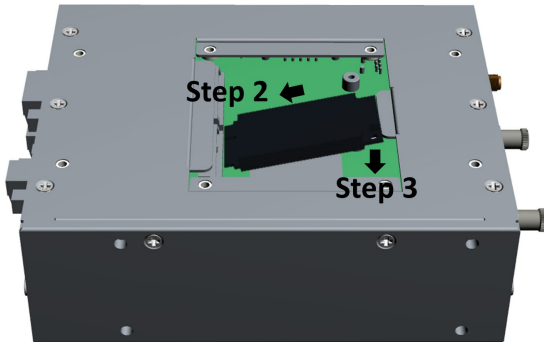

STEP 4: Connect the connectors with the corresponding wireless module cards.

The following figure illustrates 5 connectors in the mini-PCIe sockets:

- No.1 & No.3: Wi-Fi mini-PCIe card
- No.2 & No.4: 3G/LTE mini-PCIe card
- No.5: GPS

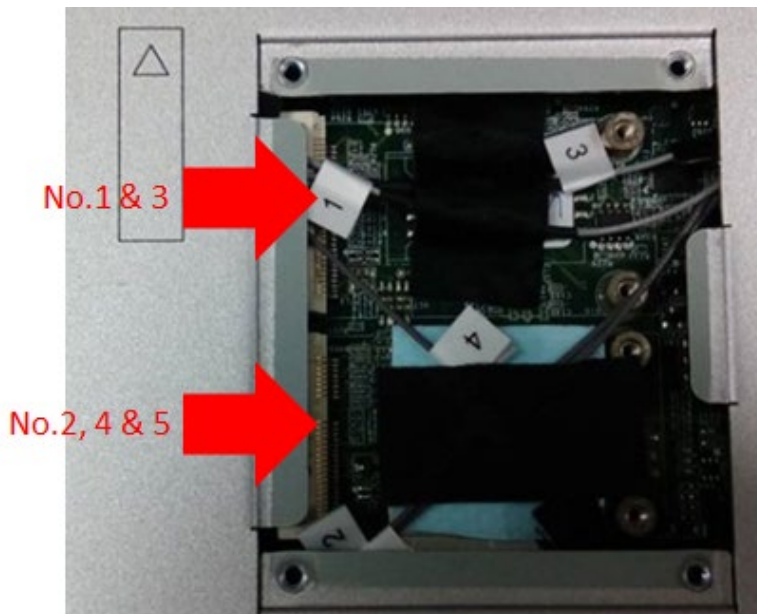

STEP 5: Replace the bottom cover.

STEP 6: You may also purchase external antennas for 3G, 4G, and Wi-Fi from Moxa. Please contact a Moxa sales representative for information. When installed, the product should appear as shown below:



Connecting to the Network

Connect your network cable to the embedded computer’s Ethernet port. The other end of the cable should be connected to your Ethernet network. When the cable is properly connected, the LEDs on the embedded computer’s Ethernet port turns on to indicate a valid connection.

Two 10/100/1000 Mbps Ethernet ports using RJ45 connectors are located on the front panel of the embedded computer. See the following figure for the location of the Ethernet ports and the pin assignments.

NOTE The pin assignments for the V2201 computer’s Ethernet port are shown in the following figure. If you create your own Ethernet cable, make sure that you match the pin assignments on the connector of the Ethernet cable.

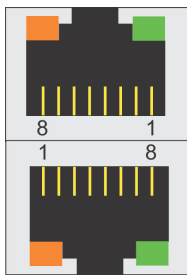
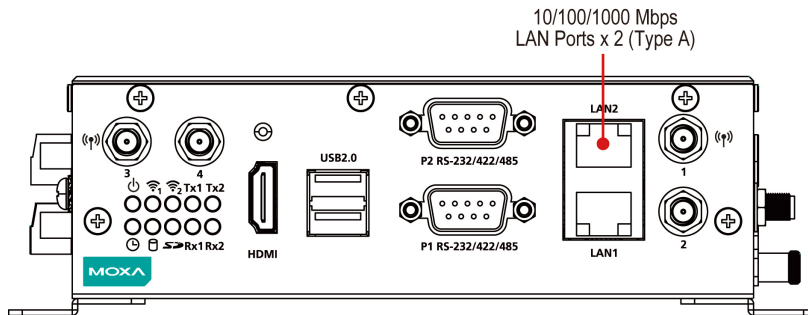

Pin	10/100 Mbps	1000 Mbps
1	ETx+	TRD(0) +
2	ETx-	TRD(0) -
3	ERx+	TRD(1) +
4	–	TRD(2) +
5	---	TRD(2) -
6	ERx-	TRD(1) -
7	–	TRD(3) +
8	–	TRD(3) -

Connecting to a Serial Device

Use a serial cable to connect your serial device to the embedded computer’s serial port. Serial ports P1 to P2 have male DB9 connectors and can be configured for RS-232, RS-422, or RS-485 communication (refer to the software manual for your operating system version). The pin assignments are shown in the following table:

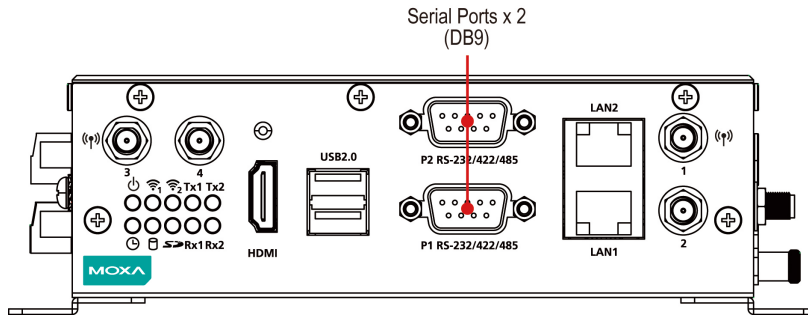

DB9 Male Port

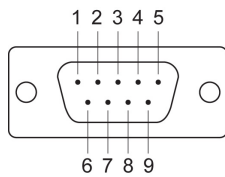

RS-232/422/485 Pinouts

Pin	RS-232	RS-422	RS-485 (4-wire)	RS-485 (2-wire)
1	DCD	TxDA(-)	TxDA(-)	-
2	RxD	TxDB(+)	TxDB(+)	-
3	TxD	RxDB(+)	RxDB(+)	DataB(+)
4	DTR	RxDA(-)	RxDA(-)	DataA(-)
5	GND	GND	GND	GND
6	DSR	-	-	-
7	RTS	-	-	-
8	CTS	-	-	-

Installing an SDHC/SDXC Card

The V2201 has an SD slot for storage expansion. The SD slot allows users to plug in a Secure Digital (SD) memory card compliant with the SD 3.0 standard. The following steps show how to install the SD card.

1. Disconnect the V2201 from its power source.
2. The SD slot is located on the right side of the front panel. Loosen the screws on the SD/SIM card cover.

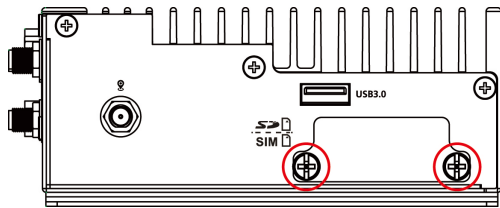

3. Press the SD card to eject it.
When you want to insert it back into the SD slot, slide it into the slot and then push it in with your finger until it latches firmly.



ATTENTION

Be sure to properly orient the CFast card when installing it; otherwise, you may not be able to insert the card all the way into the slot.

4. After the SD card is installed correctly, fasten the screws on the SD/SIM card cover.

Connecting to a USB Device

The V2201 comes with one USB 3.0 host with type-A connector on the right side panel and two USB 2.0 hosts with type-A connectors on the front panel. These ports can be used for connecting to an external flash disk or hard drive for storing data. You can also use these USB ports to connect to a keyboard or a mouse.

The following figures show the locations of the USB ports.

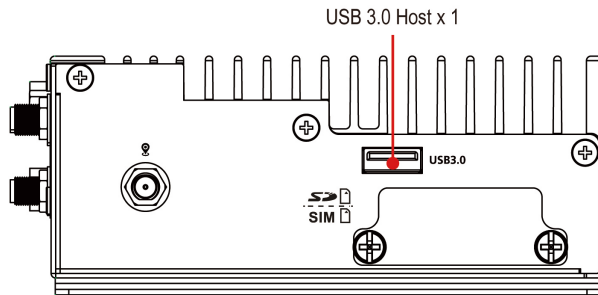
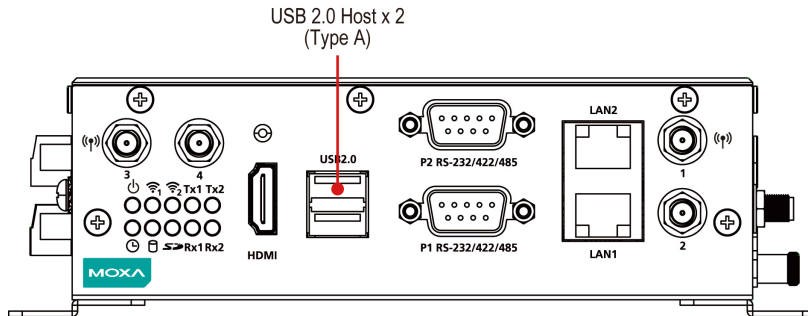

DI/DO

The V2201 comes with a 4-ch digital input and a 4-ch digital output that connect through a terminal block connector. The pin assignments and wiring methods are shown below.

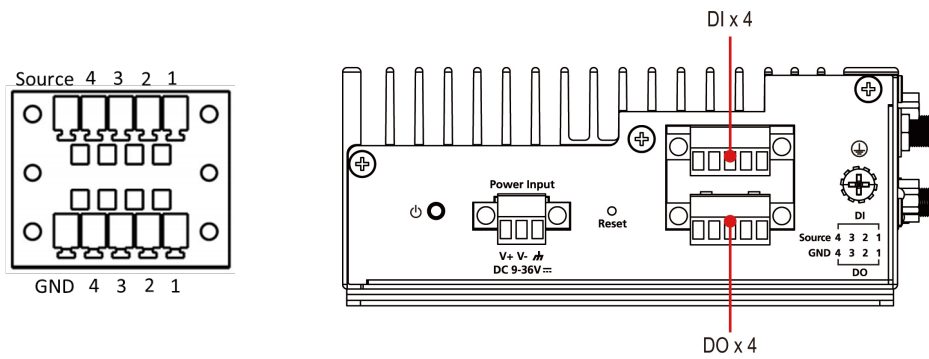

DI Dry Contact

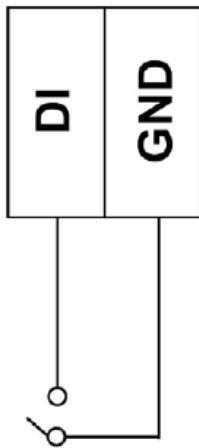

DI Wet Contact

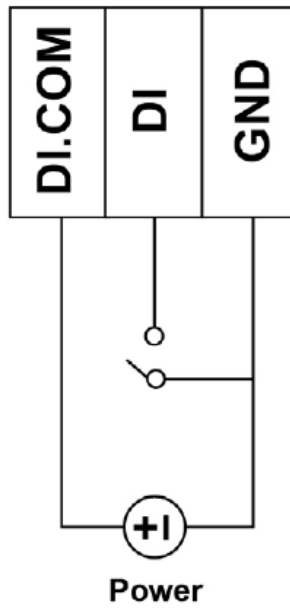

DO Contact

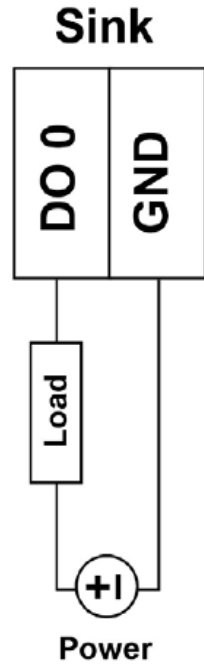

Connecting to an HDMI Monitor

The V2201 comes with a type A HDMI female connector on the front panel to connect an HDMI monitor.

The screw hole above the HDMI connector can be used to install a customized lock for the HDMI connector (note that different HDMI connector are not all the same).

Please contact a Moxa sales representative if you would like to order a customized lock.

The lock for the screw hole



Finished look



RTC Battery Replacement

The V2201's real-time clock is powered by a lithium battery. We strongly recommend that you do not replace the lithium battery without help from a qualified Moxa support engineer. If you need to change the battery, contact the Moxa RMA service team.



ATTENTION

There is a risk of explosion if the battery is replaced by an incorrect type of battery.

NOTE

The V2201 embedded computer can be customized to support an easy RTC battery replacement function. Please contact your Moxa sales representative for details.

BIOS Setup

In this chapter, we describe the BIOS settings for the V2201 embedded computer. The BIOS is a set of input/output control routines for peripherals. The BIOS is used to initialize basic peripherals and helps boot the operating system before the operating system is loaded. The BIOS setup allows the user to modify the system configurations of these basic input/output peripherals. All of the configurations are stored in the CMOS RAM, which has a backup battery power in case the computer is not connected to a power source. Consequently, the data stored in the CMOS RAM is retained when the system is rebooted or the power is disconnected.

The following topics are covered in this chapter:

❑ Entering the BIOS Setup

❑ Main Information

❑ Advanced Settings

- Boot Configuration
- PCI Express Configuration
- USB Configuration
- SD Configuration
- Miscellaneous Configuration
- SATA Configuration
- Console Redirection
- Hardware Monitor
- SMART RECOVERY Info

❑ Security Settings

- Set Supervisor Password

❑ Power Settings

- Wake on LAN
- Auto Wake on S5

❑ Boot Settings

- Boot Type
- PXE Boot to LAN
- PXE Boot capability
- Add Boot Options
- USB Boot
- Boot Delay Time
- Automatic Failover
- Boot Order Priority
- Legacy

❑ EFI

❑ Exit Settings

- Exit Saving Changes
- Save Change Without Exit
- Exit Discarding Changes
- Load Optimal Defaults
- Load Custom Defaults
- Save Custom Defaults
- Discard Changes

❑ Upgrading the BIOS

Entering the BIOS Setup

To enter the BIOS setup utility, press the **F2** key while the system is booting up. The main **BIOS Setup** screen appears with the following options:

- **Continue:** Continue to boot up
- **Boot Manager:** Select the device to boot up
- **Boot From File:** Select the UEFI boot up file
- **SCU:** Enter the BIOS configuration.

Click **SCU** to enter the **BIOS configuration**.



When you click **SCU**, a basic description of each function key is listed at the bottom of the screen. Refer to these descriptions to learn how to use them.

F1: Help

F5/F6: Change Values

F9: Setup Defaults

F10: Save and Exit

↑ ↓: Select Item

← →: Select Menu

ESC: Exit

ENTER: Select or go to Submenu.

Main Information

The main page shows basic system information, such as the model name, BIOS version, and CPU type.

NOTE The “Processor Type” varies depending on the product model.

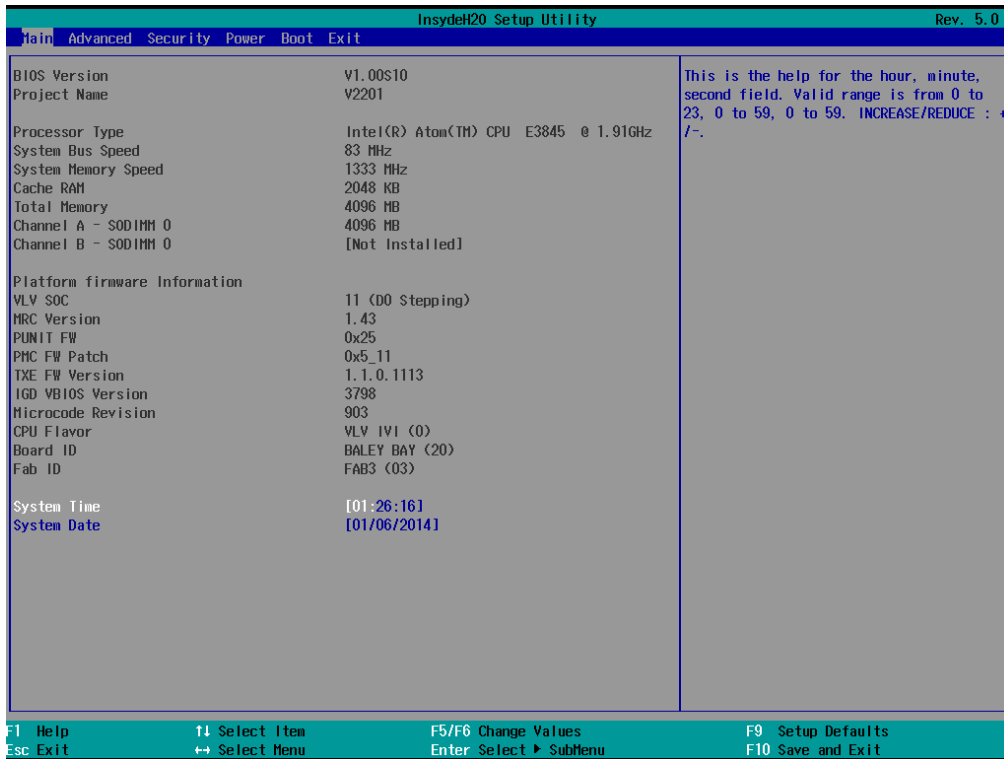

Advanced Settings

The **Advanced** screen appears when you select “Advanced” from the main menu.

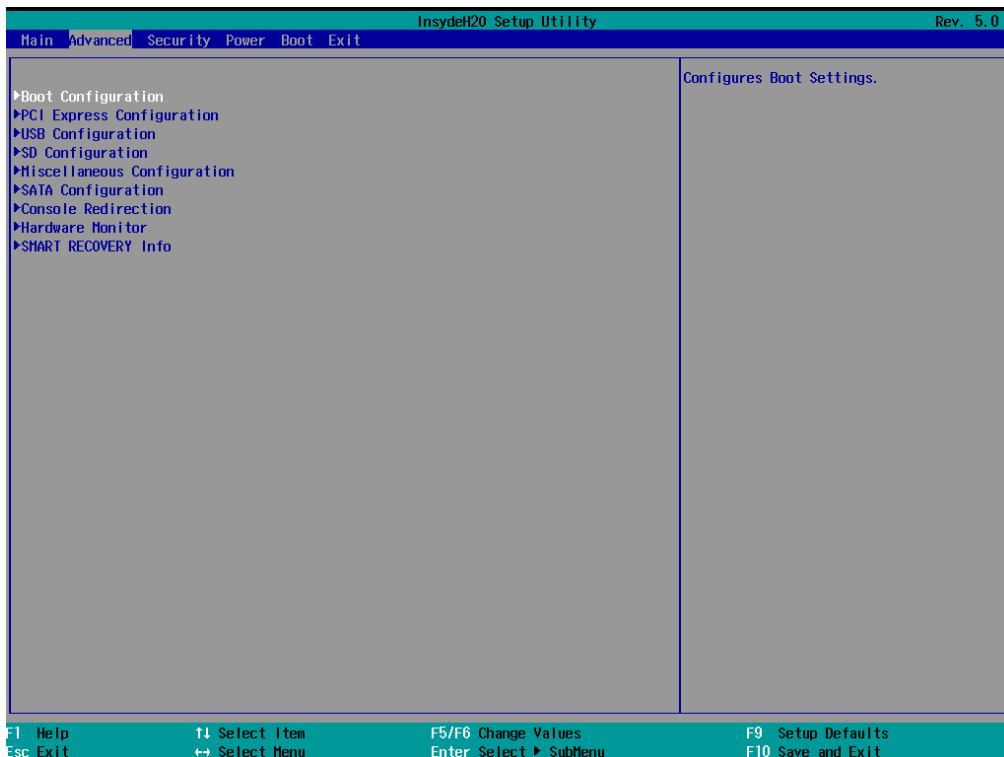

Boot Configuration

This screen allows you to configure the initial status of the Numlock key when the computer boots up.

Options: On (default), Off

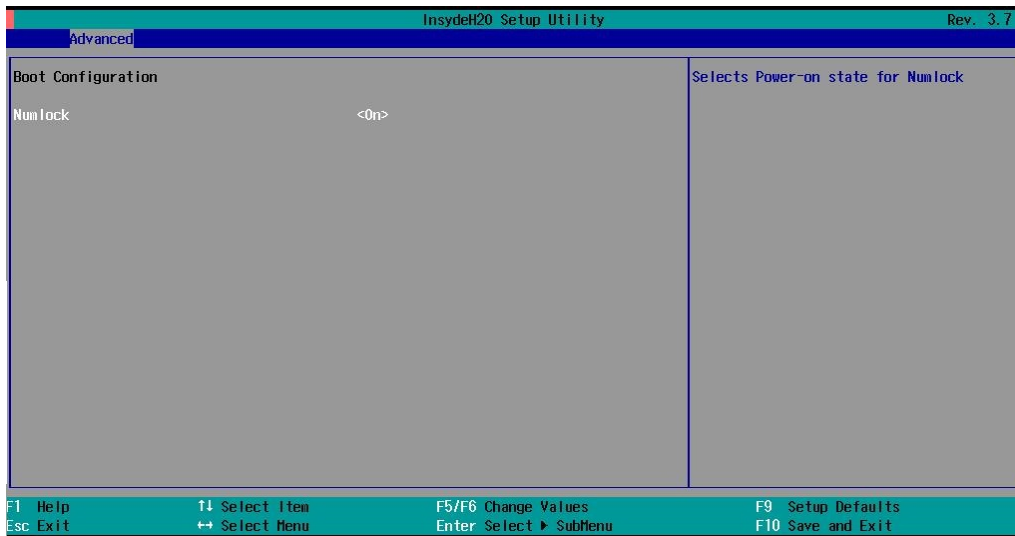

PCI Express Configuration

PCIE PORT 1 Speed

Configure PCIe Port1 Speed

Options: Auto, Gen1 and Gen2

PCIE PORT 2 Speed

Configure PCIe Port2 Speed

Options: Auto, Gen1 and Gen2

PCIE PORT 3 Speed

Configure PCIe Port3 Speed

Options: Auto, Gen1 and Gen2

PCIE PORT 4Speed

Configure PCIe Port4 Speed

Options: Auto, Gen1 and Gen2

USB Configuration

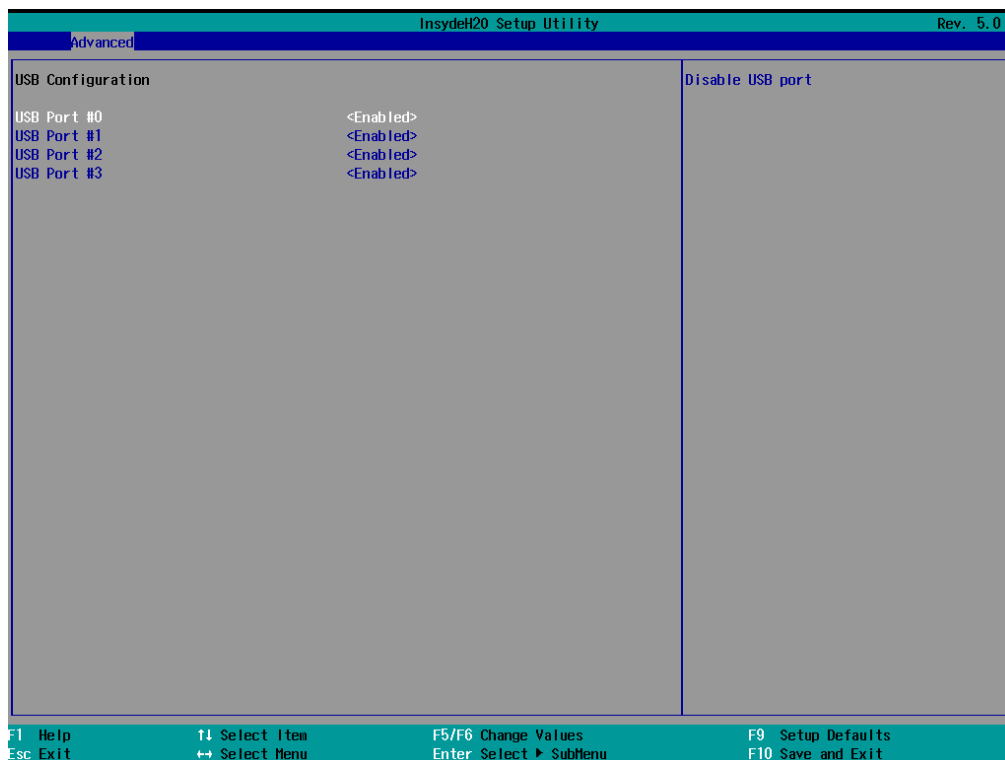

USB Port #0

Enable or Disable USB port 0; if disabled, the system won't detect when a USB device is plugged in.

Option: Enabled (default), Disabled

USB Port #1

Enable or Disable USB port 1; if disabled, the system won't detect when a USB device is plugged in.

Option: Enabled (default), Disabled

USB Port #2

Enable or Disable USB port 2; if disabled, the system won't detect when a USB device is plugged in.

Option: Enabled (default), Disabled

USB Port #3

Enable or Disable USB port 3; if disabled, the system won't detect when a USB device is plugged in.

Option: Enabled (default), Disabled

SD Configuration

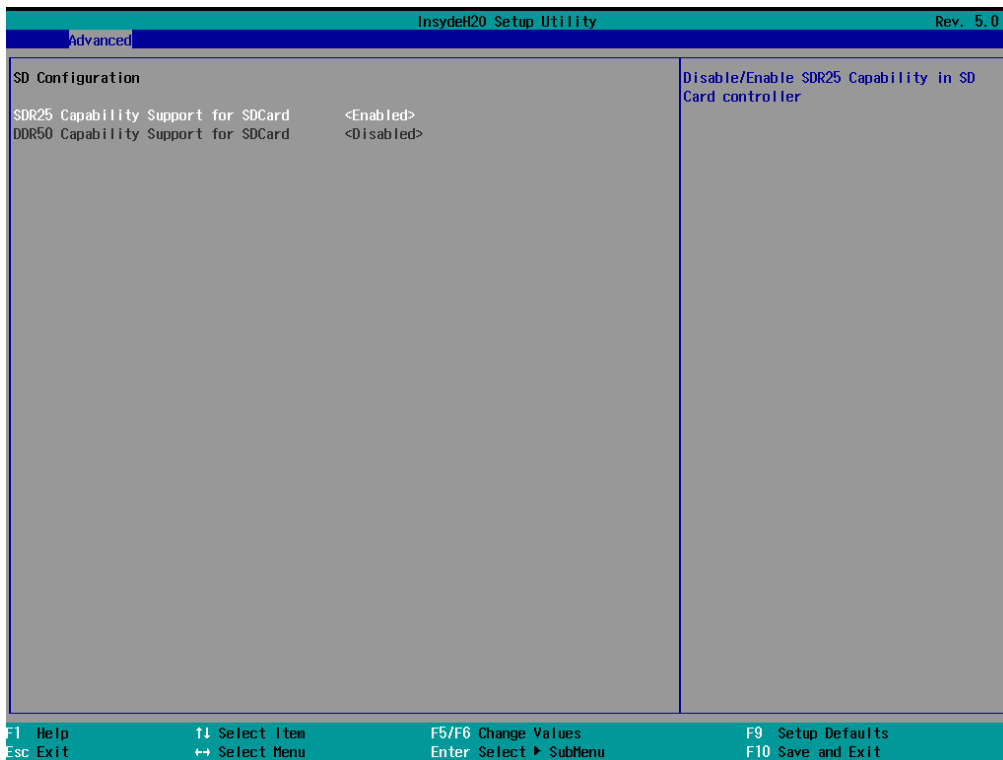

SDR25 Capability Support for SD Card

Set Input/output timing for SDR25 mode.

Option: Enabled (default), Disabled

DDR50 Capability Support for SD Card

Set Input/output timing for DDR50 mode.

Option: Enabled (default), Disabled

Miscellaneous Configuration

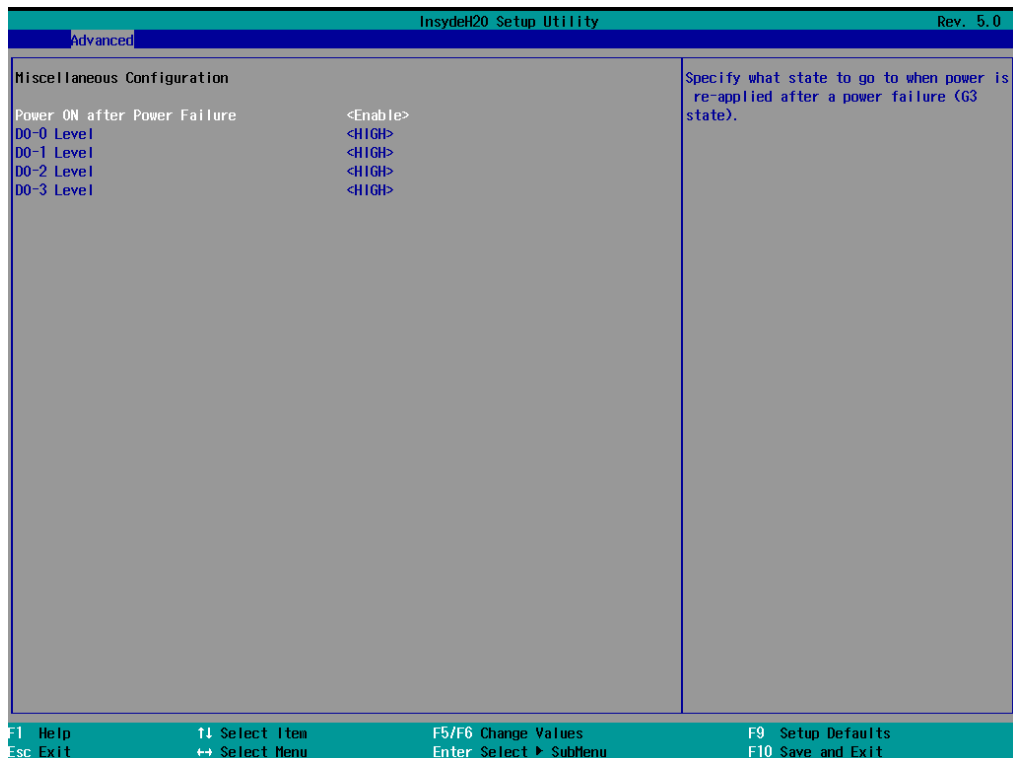

Power ON after Power Failure

This setting allows you to configure whether or not the computer automatically powers up after a system crash. When set to ON, the computer will automatically power up after a system crash; when set to OFF, it won't automatically power up after a system crash. Options: ON (default), OFF, Last State.

DO-0 Level

This item allows you set the DO 0 as high or low.

Options: High (default), Low

DO-1 Level

This item allows you set the DO 1 as high or low.

Options: High (default), Low

DO-2 Level

This item allows you set the DO 2 as high or low

Options: High (default), Low

DO-3 Level

This item allows you set the DO 3 as high or low.

Options: High (default), Low

SATA Configuration

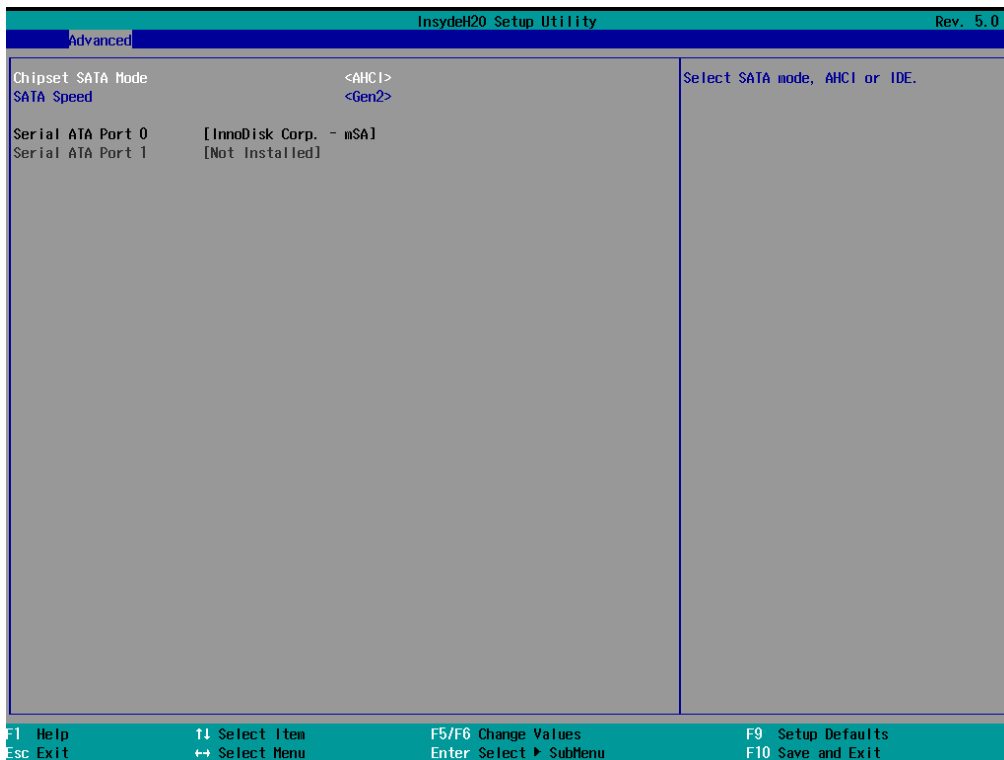

Chipset SATA Mode

Select SATA mode

Options: AHCI (default), IDE

SATA Speed

Select SATA Speed

Options: Gen1 (default), Gen2

Console Redirection

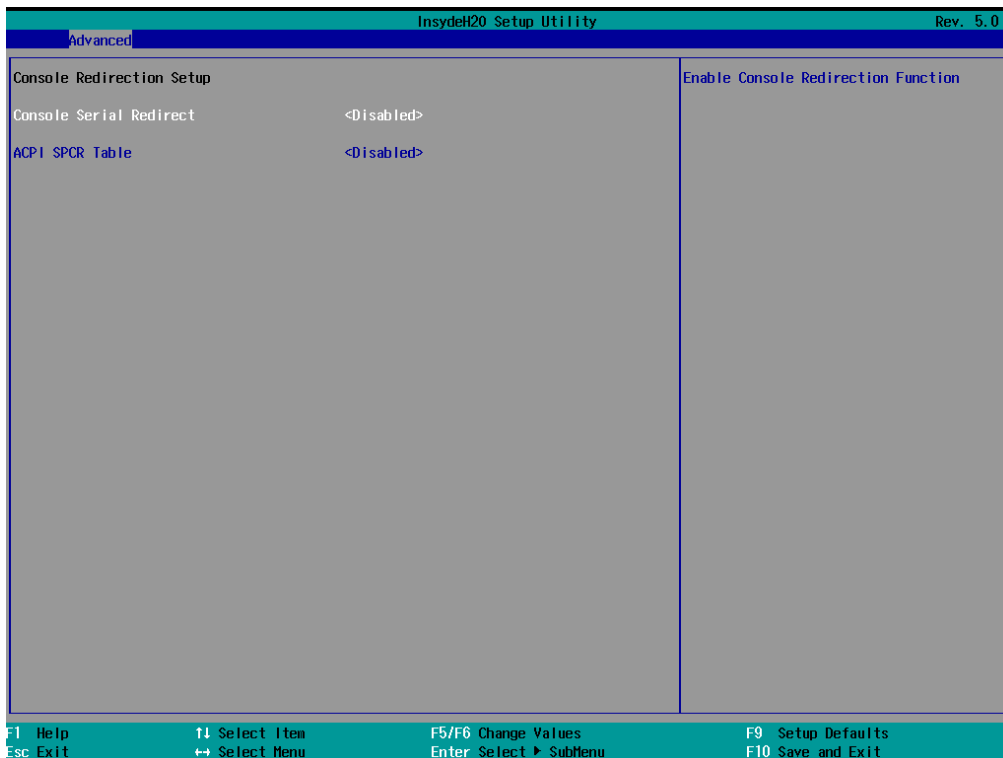

Console Serial Redirect

When the Console Redirection Function is enabled, the console information will be output to both the HDMI monitor and through the serial port.

Options: Disabled (default), Enabled

ACPI SPCR Table

This table is used to indicate whether a serial port or a non-legacy UART (Universal Asynchronous Receiver/Transmitter) interface is available for use with Microsoft Windows Emergency Management Services (EMS).

Options: Disabled (default), Enabled

Hardware Monitor

This screen allows you to view voltage levels, system temperature, and CPU temperature.

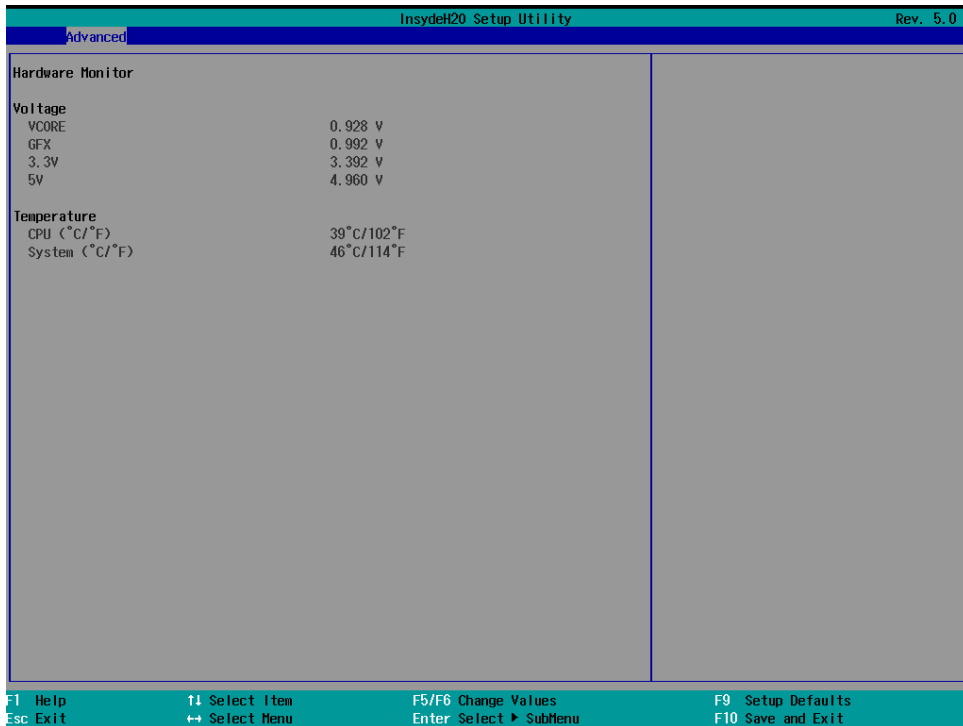

Note that the voltage values vary depending on the model. The temperature readings shown on the screen are within ±5% of the actual readings. However, the temperature readings are only valid when the ambient temperature is above 0°C.

SMART RECOVERY Info

This screen allows you to view Smart Recovery information.

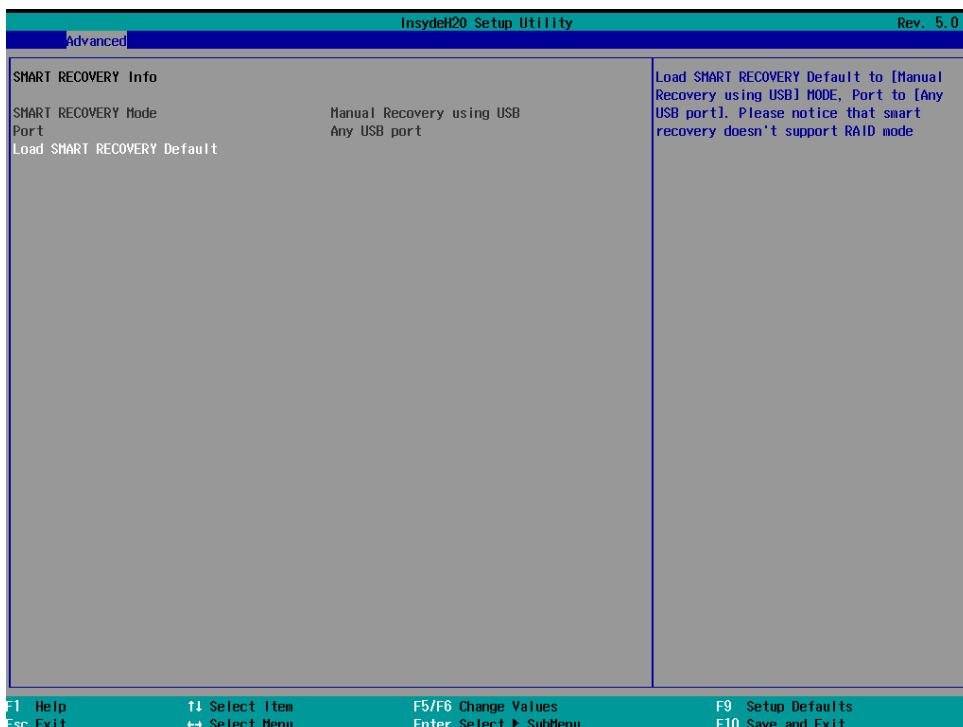

Load SMART RECOVERY Default

This setting allows you to load the Smart Recovery default value. Refer to the Smart Recovery Website at <http://www.moxa.com/product/Smart-Recovery.htm> for details

Options: Yes (default), No

Security Settings

This screen allows you to configure a supervisor password.

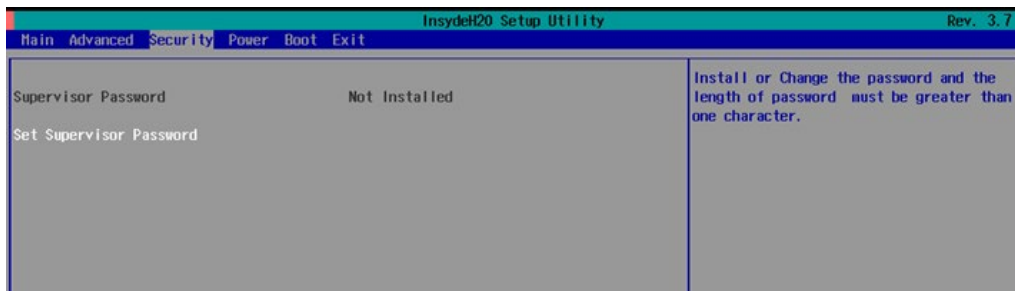

Set Supervisor Password

This setting allows you set the supervisor password.

Type the new password, and then retype the password again to confirm.

To delete the password, enter the existing password in the **Set Supervisor Password** field and leave the new password fields blank; then, press [Enter].

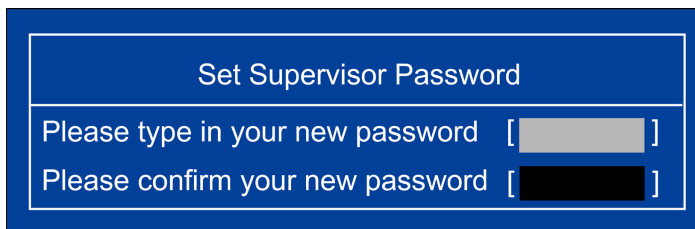
The image shows a dialog box titled 'Set Supervisor Password'. It has a blue background and a white border. Inside the dialog, there are two lines of text with input fields: 'Please type in your new password []' and 'Please confirm your new password []'. The input fields are currently empty.

Power Settings

The screen allows you to configure power settings.



Wake on LAN

This setting allows you to wake the system over the LAN from a remote host.

Options: Enabled (default), Disabled.

Auto Wake on S5

This setting allows you to configure the computer to wake from the S5 (Soft Off) state where the power supply remains engaged but is not supplying power to all other parts of the system.

You can set the auto-wake on S5 schedules for the system to perform a soft-reboot at specific times.

Options: Disabled (default); By Every Day (user specifies at what time each day the computer will power up); By Day of Month (user specifies which day of each month the computer will power up)

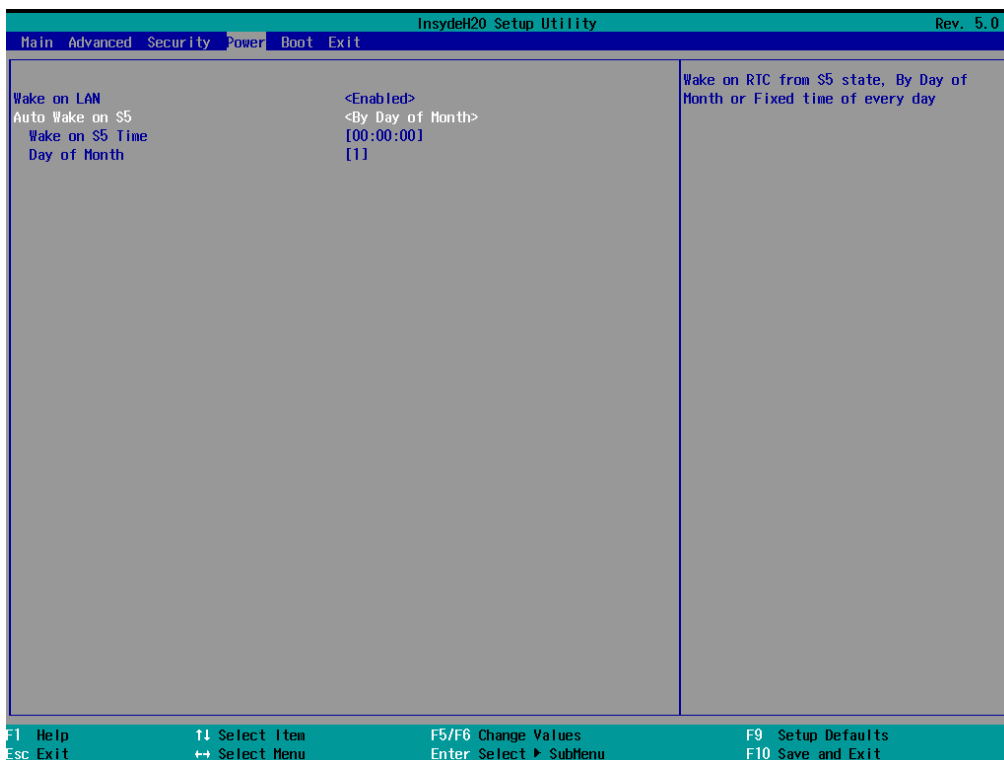
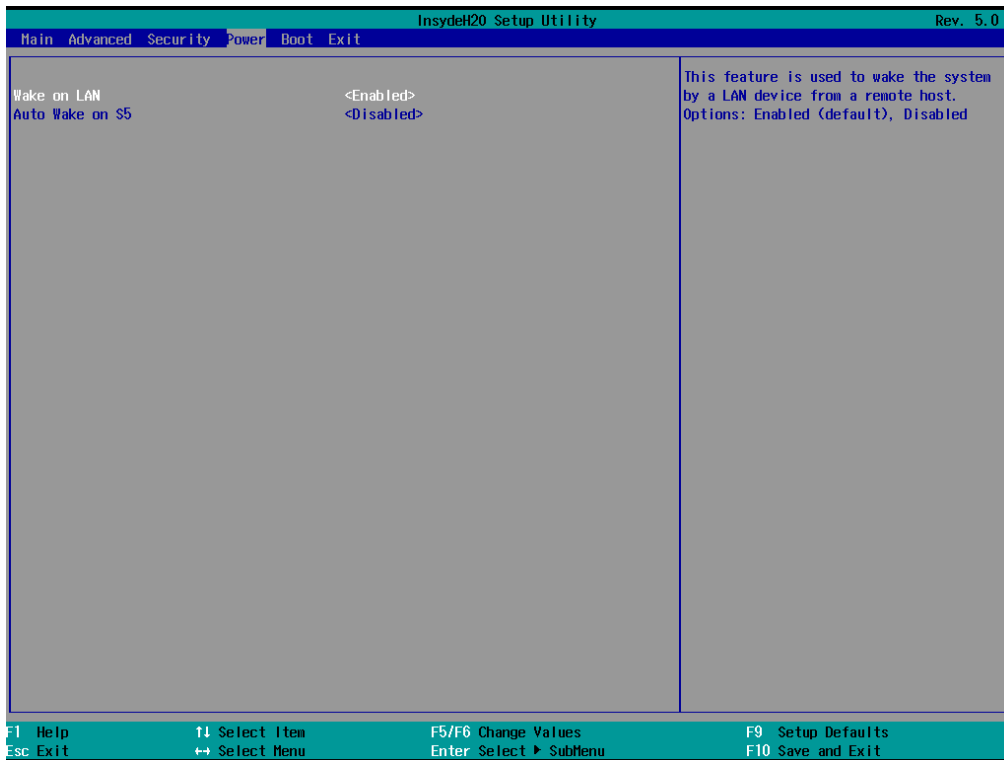

Boot Settings

The screen allows you to configure boot settings.

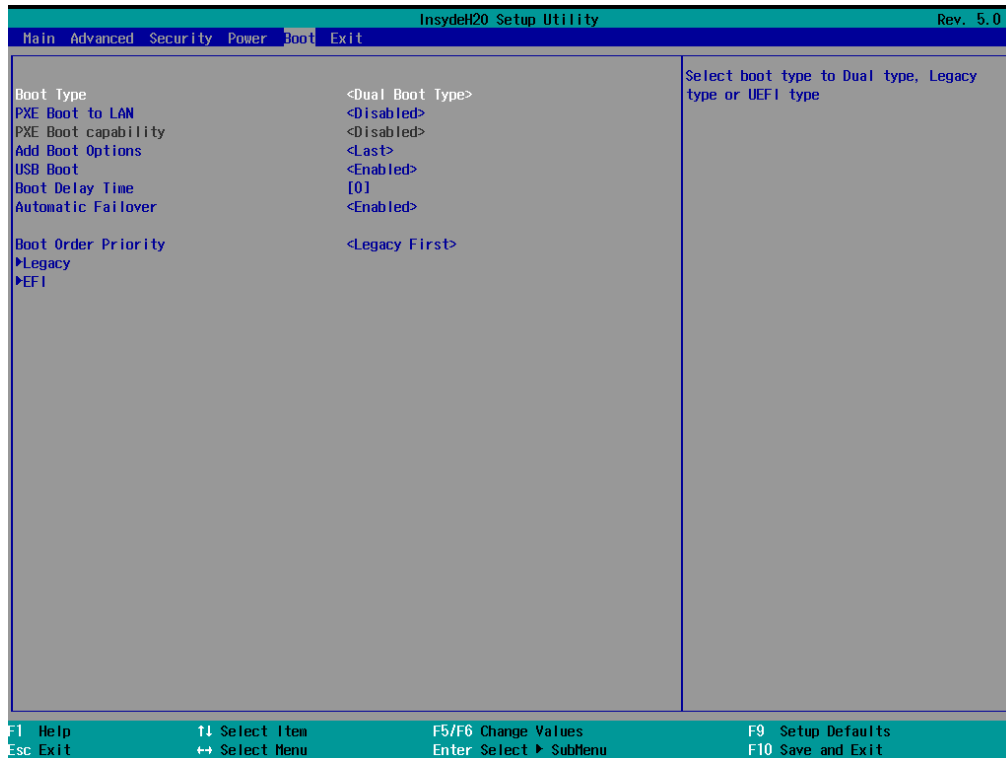

Boot Type

The system will be based on the value used to build the boot environment for different types of operating systems.

Options: Dual Boot Type (default), Legacy Boot Type, UEFI Boot Type

PXE Boot to LAN

This setting allows you to enable or disable the PXE boot to LAN function.

Options: Disabled (default), Enabled

PXE Boot capability

This function is enabled while PXE Boot to LAN enabled.

Supports Network Stack UEFI PXE or Legacy.

Options: Disabled (default), UEFI: IPv4, Legacy

Add Boot Options

This setting allows you to add boot order options for new boot devices and removable devices, such as a USB drive.

Options: Last (default), First, Auto

USB Boot

This setting allows you to enable or disable the USB boot function.

Options: Enabled (default), Disabled

Boot Delay Time

This setting allows you to configure the delay time to enter a hot key during POST.

Options: 0 Second (default), User define

Automatic Failover

Options: Enabled (default), Disabled

Enable: If boot to default device fails, it will try to boot the next device.

Disable: If boot to default device fails, a warning message will pop up.

Boot Order Priority

This setting allows you to determine the booting priority of the EFI device. If this setting is EFI first, the EFI device will boot first; if Legacy first, the legacy device will boot first.

Options: Legacy first (default), EFI first

Legacy

Normal Boot Menu

This setting allows you to configure the boot menu.

Options: Normal (default), Advance

Boot Type Order

This setting allows you to configure the boot order. To change the boot order, press the "-" or "F5" key to an item move down the list, and the "+" or "F6" key to move up.

Options: Hard Disk Drive (default), CD/DVD-ROM Drive, USB, Others

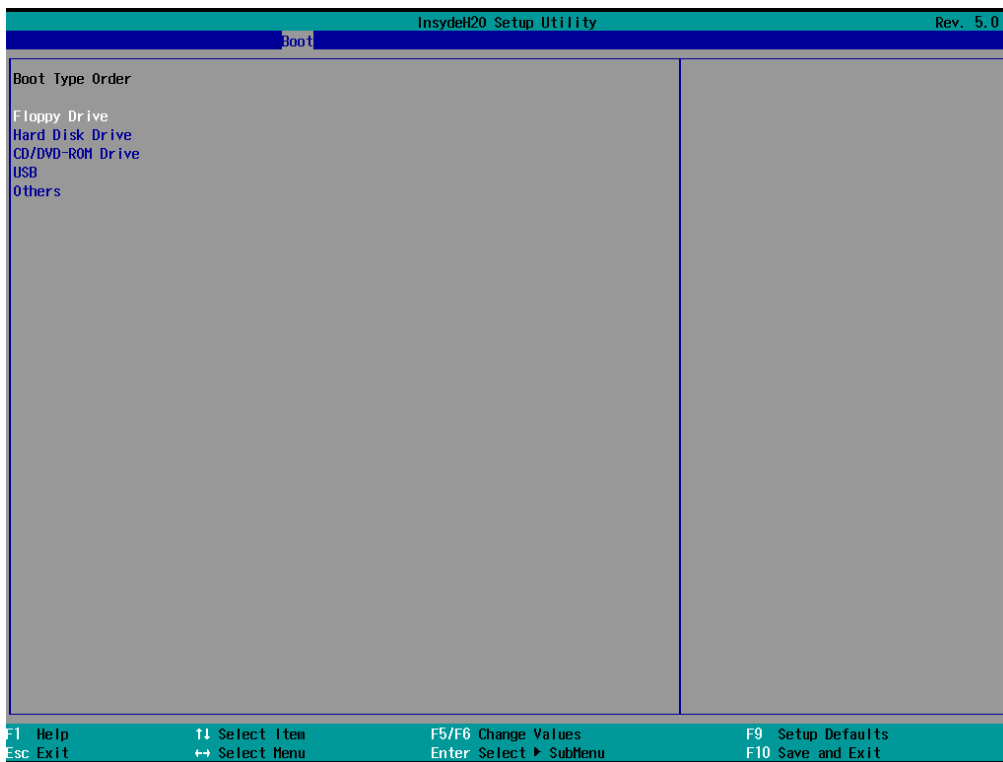

EFI

Adjust boot order settings for an EFI device.

Exit Settings

The screen shows the various options to exit from the BIOS setup utility.

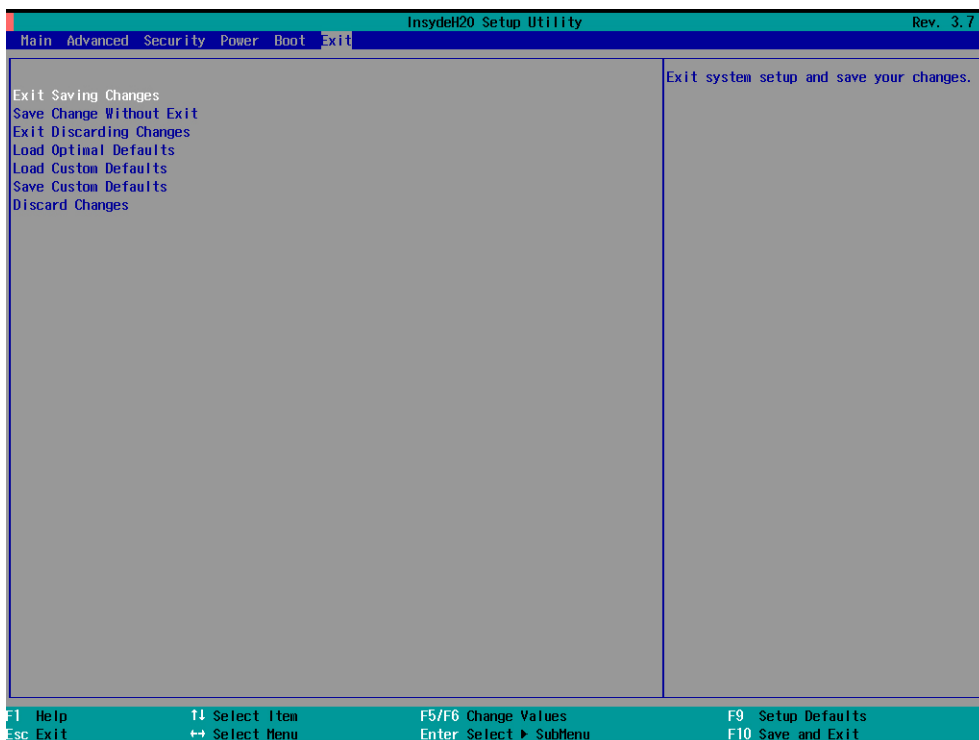

Exit Saving Changes

This option allows you to exit the BIOS setup utility and save the values you have just configured.

Options: Yes (default), No

Save Change Without Exit

This option allows you to save changes without exiting the BIOS setup utility.

Options: Yes (default), No

Exit Discarding Changes

This option allows you to exit without saving that changes that might have been made to the BIOS.

Options: Yes (default), No

Load Optimal Defaults

This option allows you to revert to the factory default BIOS values.

Options: Yes (default), No

Load Custom Defaults

This option allows you to load the custom default BIOS settings.

Options: Yes (default), No

Save Custom Defaults

This option allows you to save the current BIOS settings as a "custom default" that you can load at any time using the "Load Custom Defaults" option.

Options: Yes (default), No

Discard Changes

This option allows you to discard all settings you have just configured.

Options: Yes (default), No

Upgrading the BIOS

This section describes how to upgrade the BIOS.



WARNING

An improper BIOS upgrade process may permanently damage the computer. We strongly recommend that you contact Moxa technical support for assistance to obtain all the necessary tools and the most up-to-date advice before attempting to upgrade the BIOS on any Moxa device.

Step 1: Create a Bootable USB Disk

Before upgrading the BIOS, every user should first create a bootable USB drive as a system rescue device.

A useful software suite for creating USB RAM drives can be found by searching for Rufus, which can then be downloaded and used to create a bootable RAM drive.

Complete the following steps to create a bootable USB disk using Rufus:

1. Start Rufus and then in the "Device" drop-down list select the USB device that you want to use as a bootable disk.
2. Select **MBR partition scheme for BIOS or UEFI computers** from the "Partition scheme and target system type" drop-down list so it can boot from a legacy BIOS or UEFI.
3. Select **FAT32 (Default)** from the "File system" drop-down list.
4. Select **4096 bytes (Default)** from the "Cluster size" drop-down list.
5. Enter a drive name in the "New volume label" input box.
6. Select the **Quick format, Create a bootable disk using FreeDOS, and Create extended label and icon files** options.
7. Click **Start** to format and create the bootable USB drive.

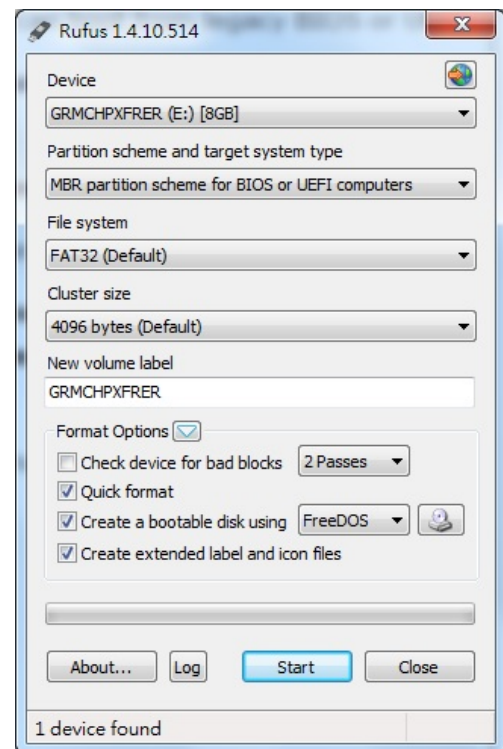

ATTENTION

When you use a USB drive larger than 4 GB, you will need to convert the file system type to FAT32.

Step 2: Prepare the Upgrade File

You must use the BIOS upgrade installation file to upgrade the BIOS. Contact Moxa technical support for assistance.

1. Get the BIOS upgrade installation file.
The file name should be in the format: **V2201_VxxxSxx.exe** (where "xx" refers to the version numbers).
2. Copy the file to the bootable USB drive.

Step 3: Run the Upgrade Program on the V2201 Computer

1. Reboot the computer, and press F2 during the booting process to display the Boot Manager.

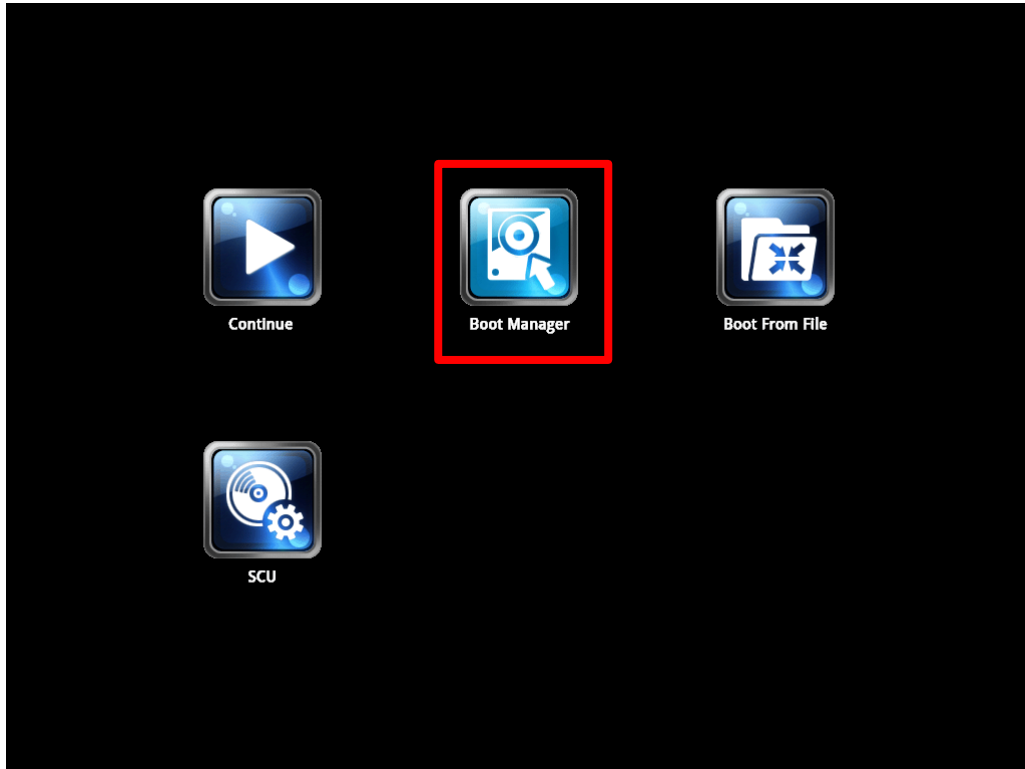

2. Select USB Disk as the first boot source and press [Enter] to continue.

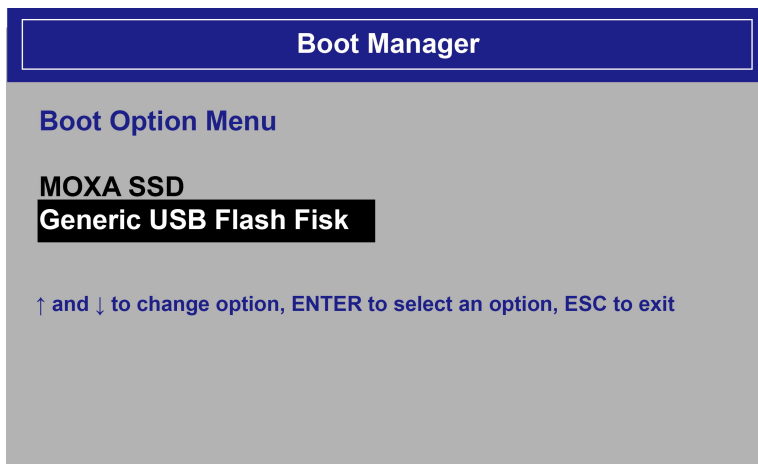

3. When the computer finishes booting up, a command window appears. Go to the directory where the upgrade file is located. For example, if the upgrade file is stored in the V2201 folder, type `cd v2201`.

```
C:\>cd v2201
```

4. Run the upgrade program by typing `v2201s10.exe`.

Note that the filename for the upgrade program may vary depending on the version.

```
C:\ v2201>v2201s10.exe
```

5. The upgrade program will run automatically. Wait until the procedure is complete.



ATTENTION

Do NOT remove the power supply during a BIOS upgrade.

```
C:\> V2201>V2201S10.exe
Option: -bios -all -nv
```

Please do not remove the AC power!

```
Insyde H20FFT (Flash Firmware Tool) Version (SEG) 100.00.07.20
Copyright(c) 2012 - 2014, Insyde Software Corp. All Rights
Reserved.

Initializing

Current BIOS Model name: V2201
New BIOS Model name: V2201

Current BIOS version: V1.00S10
New BIOS version: V1.00S10

Updating Block at FFFFF000
```

0% 25% 50% 75% 100%



100%

- When the upgrade is finished, the computer automatically reboots. You may check the BIOS version on the Main page of the BIOS setup utility.

BIOS Version	V1.00S10
Project Name	V2201

A

Regulatory Approval Statement



This device complies with part 15 of the FCC Rules. Operation is subject to the following two conditions: (1) This device may not cause harmful interference, and (2) this device must accept any interference received, including interference that may cause undesired operation.

Class A: FCC Warning! This equipment has been tested and found to comply with the limits for a Class A digital device, pursuant to part 15 of the FCC Rules. These limits are designed to provide reasonable protection against harmful interference when the equipment is operated in a commercial environment. This equipment generates, uses, and can radiate radio frequency energy and, if not installed and used in accordance with the instruction manual, may cause harmful interference to radio communications. Operation of this equipment in a residential area is likely to cause harmful interference in which case the user will be required to correct the interference at his or her own expense.



European Community

Warning:

This is a class A product. If used in a domestic environment, this product may cause undesirable radio interference, in which case the user may be required to take adequate measures to prevent the interference from affecting nearby devices.