

AIG-501-T-AZU-LX

Quick Installation Guide

Advanced IIoT gateway with Intel Atom® quad-core 1.91 GHz processor, 1 VGA port, 4 DIs, 4 DOs, ThingsPro Edge and Azure IoT Edge software, -40 to 70°C operating temperature

Version 1.0, January 2022

Technical Support Contact Information
www.moxa.com/support

MOXA®

© 2022 Moxa Inc. All rights reserved.

P/N: 1802005010020



Package Checklist

Before installing the device, verify that the package contains the following items:

- AIG-501-T-AZU-LX advanced IIoT gateway
- Power jack
- Quick installation guide (printed)
- Warranty card



IMPORTANT!

Neither the wall mounting kit nor DIN-rail mounting kit come with the package. They must be purchased separately as needed. Notify your sales representative if any of the above items are missing or damaged.

Panel Views

The following figures show the panel layouts of the AIG-501-T-AZU-LX.

Top Panel

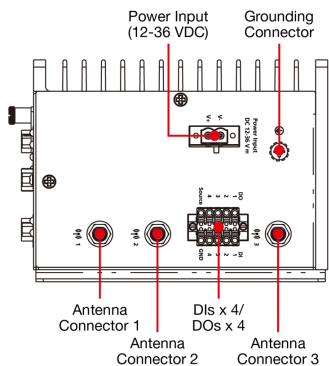

Bottom Panel

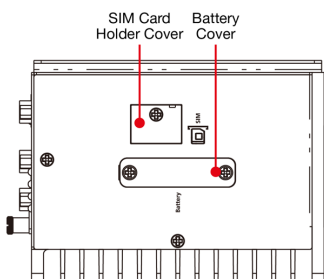

Front Panel

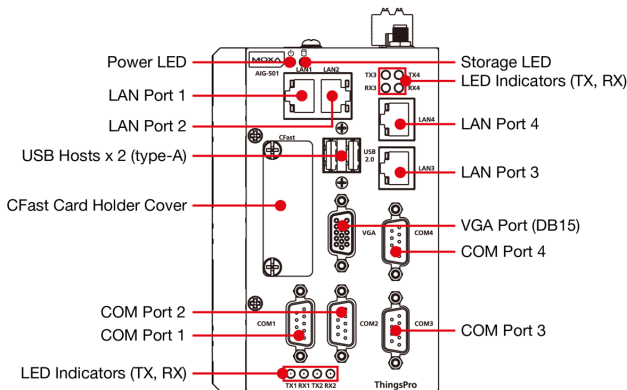

LED Indicators

LED Name	Status	Function	
Power	Green	Power is ON	
	OFF	No power	
Storage (CFast)	Yellow	Blinking	Data is being written to or read from the storage.
	OFF	No activity	
LAN1/LAN2/ LAN3/LAN4 (RJ45)	Green	Steady ON	100 Mbps Ethernet link
		Blinking	Data is being transmitted or received
	Yellow	Steady ON	1000 Mbps Ethernet link
		Blinking	Data is being transmitted or received
	OFF	No Ethernet connection or 10 Mbps Ethernet link	
TX1/TX2/ TX3/TX4	Green	Blinking	Data is being transmitted
	OFF	No data is being transmitted	
RX1/RX2/ RX3/RX4	Yellow	Blinking	Data is being received
	OFF	No data is being received	

Mounting Instructions

DIN-rail Mounting (optional)

The optional DIN-rail mounting kit is not included in the product package and must be purchased separately.

Follow these steps to mount the device on to a DIN rail.

STEP 1:

Use 4 screws to attach the DIN-rail mounting bracket to the AIG-501-T-AZU-LX's rear panel and tighten the screws to secure the bracket.

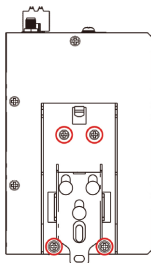

STEP 2:

Insert the upper lip of the DIN rail into the DIN-rail mounting kit.

STEP 3:

Press the AIG-501-T-AZU-LX towards the DIN rail until it snaps into place.

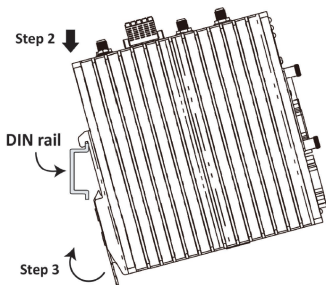

Wall Mounting (optional)

The optional wall-mounting kit is not included in the product package and should be purchased separately.

Follow these steps to mount the device on to a wall.

STEP 1:

Attach the wall-mounting brackets to the rear side of the AIG-501-T-AZU-LX by using two screws per bracket.

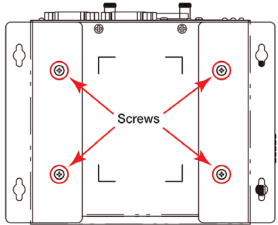

STEP 2:

Use four screws per side on the wall-mounting bracket to attach the AIG-501-T-AZU-LX to a wall or cabinet.

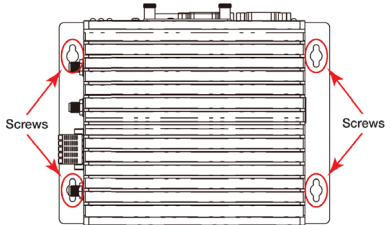

IMPORTANT!

The diameter of the screw heads should be greater than 7 mm and less than 14 mm; the diameter of the shafts should be less than 3 mm. The length of the screws should be greater than 6 mm.

NOTE

- Test the screw head and shank size by inserting the screws into one of the keyhole shaped apertures of the wall-mounting plates before attaching the plate to the wall.
- Do not drive the screws in all the way—leave a space of about 2 mm to allow room for sliding the wall-mounting panel between the wall and the screws.

Wiring Requirements

- Use separate paths to route wiring for power and devices. If power wiring and device wiring paths must cross, make sure the wires are perpendicular at the intersection point.
- You can use the type of signal transmitted through a wire to determine which wires should be kept separate. The rule of thumb is that wiring that shares similar electrical characteristics can be bundled together.
- Keep input wiring and output wiring separate.
- When necessary, it is strongly advised that you label wiring to all devices in the system.

NOTE Do not run signal or communication wiring and power wiring in the same wire conduit. To avoid interference, wires with different signal characteristics should be routed separately.

Grounding Requirements

There is a grounding connector on the top panel of the device. Use this connector to connect a well-grounded mounting surface, such as a metal panel. Grounding and wire routing help limit the effects of noise due to electromagnetic interference (EMI).

Connecting the Power Supply

Power Input
DC 12-36 V \equiv

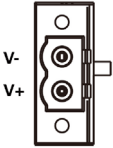

Connect the power jack (in the package) to the DC terminal block (located on the top panel), and then connect the power adapter. It takes about 3 minutes for the system to boot up. Once the system is ready, the power LEDs will light up.

Use wires with 16 to 24 AWG (1.318 to 0.205 mm²) to connect to V+, V-, and GND. The wire size of the power input and the earthing conductor should be the same.



WARNING

- This product is intended to be supplied by a UL Listed Power Adapter or DC power source marked "L.P.S." (or "Limited Power Source") rated 12 to 36 VDC, 2.5 A (minimum), and TMA = 70°C (minimum).
- The power adapter should be connected to a socket outlet with an earthing connection.

If you need further information or assistance, contact a Moxa representative.

Wiring the I/Os

Connecting Digital Inputs and Digital Outputs

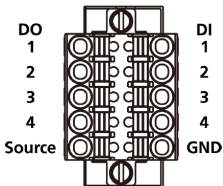

There are four digital inputs and four digital outputs on the top panel. Refer to the figure on the left for the pin definitions.

NOTE The load from the **DO Source** is not ideal for a **DO**. DO NOT use this source for device safety reasons.

DI Dry Contact

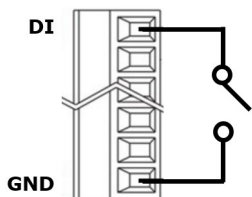

DO Channel (Sink Type)

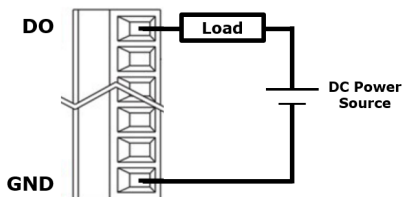

Connecting to a USB Device

The AIG-501-T-AZU-LX has one USB port with the type-A connector, allowing users to connect to a device with a USB interface.

Communication Connections

Connecting to the Network

The Ethernet ports are located on the front panel of the device. The pin assignments are shown in the following figure. If you are using your own cable, make sure that the pin assignments on the Ethernet cable connector match the pin assignments on the Ethernet port.

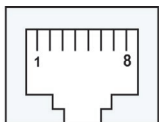

Pin	10/100 Mbps	1000 Mbps
1	Tx+	TRD(0)+
2	Tx-	TRD(0)-
3	Rx+	TRD(1)+
4	-	TRD(2)+
5	-	TRD(2)-
6	Rx-	TRD(1)-
7	-	TRD(3)+
8	-	TRD(3)-

Connecting to Serial Ports

The serial ports can be configured by software for RS-232, RS-422, or RS-485. The pin assignments for the ports are shown in the following table:

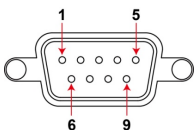

Pin	RS-232	RS-422/ RS-485 4w	RS-485 2w
1	-	TxD-(A)	-
2	RxD	TxD+(B)	-
3	TxD	RxD+(B)	Data+(B)
4	DTR	RxD-(A)	Data-(A)
5	GND	GND	GND
6	DSR	-	-
7	RTS	-	-
8	CTS	-	-

Inserting the SIM Card

The device comes with a SIM card socket that allows users to install SIM card for cellular communication. To install a SIM card, do the following:

STEP 1

Remove the screw on the SIM card holder cover located on the bottom panel of the device.

STEP 2

Insert the SIM card into the socket. Make sure you insert it in the right direction. To remove the SIM card, press it into the socket to release and then pull out the SIM card.

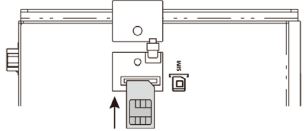
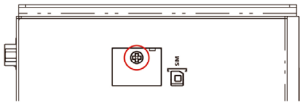

Connecting the Antennas

For the US, EU, or AP LTE models, there are two cellular antenna connectors (#1: Main and #2: Aux) and a GPS connector (#3) on the top panel of the device. All three connectors are of SMA type.

For the non-LTE model, there are two Wi-Fi antenna connectors (#1: Main and #2: Aux) on the top panel of the device. Both connectors are of RP-SMA type.

NOTE The optional Wi-Fi wireless module is not included in the product package and must be purchased separately. Refer to the AIG-500 Series hardware manual, which can be downloaded from <https://www.moxa.com>, to install the Wi-Fi module for the device.

Connecting the Device to a PC

You can use a PC to access the AIG-501-T-AZU-LX by one of the following methods:

- A. Access the web console of ThingsPro Edge via LAN 2 using <https://192.168.4.127:8443/>

Default Username: **admin**

Password: **admin@123**

- B. Use SSH over the network with the following IP addresses and login.

	Default IP Address	Netmask
LAN 1	DHCP	
LAN 2	192.168.4.127	255.255.255.0

Login: moxa

Password: moxa

NOTE For security reasons the SSH port is disabled by default. You can enable it via the ThingsPro Edge web console.

Troubleshooting

Reboot

To reboot the device, refer to the ThingsPro Edge user's manual on how to run the Reboot function. No hardware button is available for rebooting the device.

Reset to Default

Refer to the ThingsPro Edge user manual on how to run Reset-to-default function. No hardware button is available for resetting the device to the factory default.

Real-time Clock

The real-time clock is powered by a lithium battery. We strongly recommend that you do not replace the lithium battery without the help of a Moxa support engineer. If you need to change the battery, contact the Moxa RMA service team.



ATTENTION

There is a risk of explosion if the battery is replaced with an incorrect type of battery.

Product Specifications

Input Current	2.5 A @ 12 VDC
Input Voltage	12 to 36 VDC
Power Consumption	30 W (max.)
Operating temperature	-40 to 70°C (-40 to 158°F)
Storage Temperature	-40 to 75°C (-40 to 167°F)

The latest specifications for Moxa's products can be found at <https://www.moxa.com>.