



EM-1240-LX Quick Installation Guide

Third Edition, June 2008

1. Overview

Thank you for purchasing the Moxa EM-1240 Embedded Module. The product's features include 4 software-selectable RS-232/422/485 serial ports, two 10/100 Mbps Ethernet ports, and SD signals for external SD socket connections, based on the Moxa ARM9 32-bit 192 MHz communication processor. These features make the EM-1240 ideal for use as the core module of an industrial embedded system.

In addition, Moxa provides an EM-1240 Development Kit, which is designed for system and software program development at the system evaluation stage. The kit includes the EM-1240 embedded computer, and the EM-1240-DK carrier board, which is used to evaluate the EM-1240. The EM-1240's pre-installed, ready-to-run µClinux Kernel 2.6 makes it easy for users to develop programs for any application.

2. Package Checklist

Before installing the EM-1240 Development Kit, verify that the package contains the following items:

- 1 EM-1240 Embedded Module
- 1 EM-1240-DK (the carrier board of the EM-1240 Development Kit)
- Quick Installation Guide
- Document & Software CD
- Cross-over Ethernet cable
- Universal Power Adaptor
- Product Warranty Statement

Please notify your sales representative if any of the above items are missing or damaged.

3. Product Features

- Moxa ART ARM9 32-bit 192 MHz communication processor
- 16 MB RAM, 8 MB Flash ROM on the board
- 4 software-selectable RS-232/422/485 serial ports
- Dual 10/100 Mbps Ethernet ports
- RS-232 console port (supports full signal and PPP)
- Ready-to-Run µClinux Kernel 2.6.9 communication platform
- SD signals supported for external Secure Digital (SD) socket connection
- 10 GPIO reserved for system integration (NOTE: To enable GPIO, SD must first be disabled)

P/N: 1802012400012

4. Hardware Introduction

EM-1240 Embedded Module View

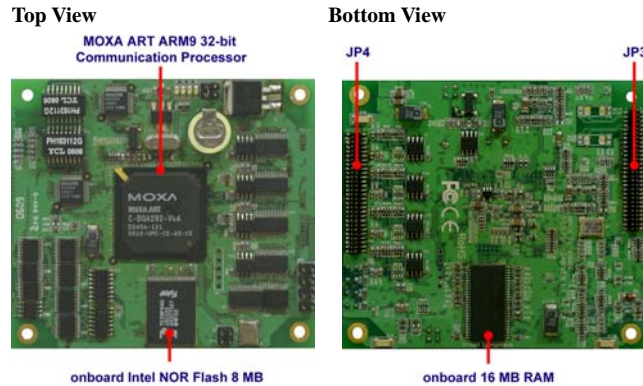

EM-1240-DK View

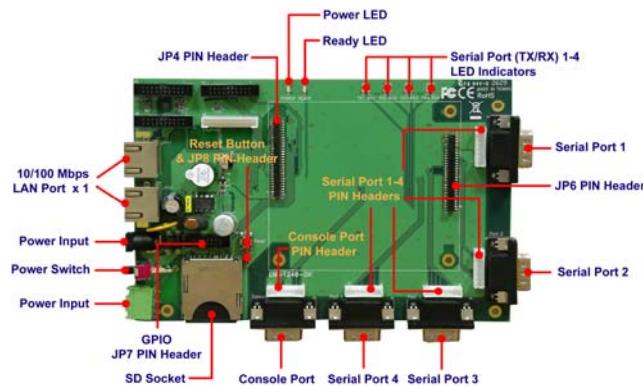

5. Combining Embedded Module with EM-1240-DK

Insert the EM-1240 embedded module vertically onto the Development Kit board. Note that the pin marked "JP4" on the embedded module must be matched with the pin marked "JP6" on the Development Kit; the pin marked "JP3" on the embedded module must be matched with the pin marked "JP4" on the development kit. Use caution when combining the boards, since improper handling could damage the boards' pins.

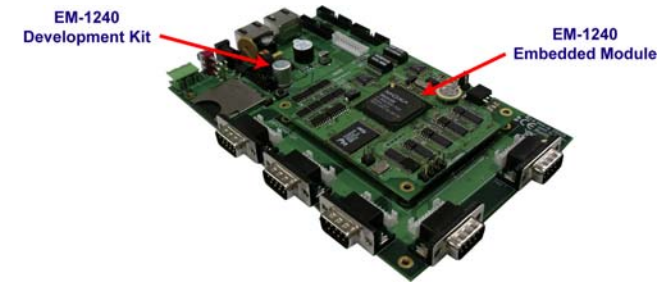

6. EM-1240-DK Introduction

LED Indicators

LED Name	Color	LED Function
Power	Green	Power is on.
Ready	Green	Power is on and system functions normally.
P1-P4 (Tx)	Green	Serial port 1-4 is transmitting data.
	Off	Serial port 1-4 is not transmitting data.
P1-P4 (Rx)	Yellow	Serial port 1-4 is receiving data.
	Off	Serial port 1-4 is not receiving data.

Serial Ports

The EM-1240 embedded module offers 4 software-selectable serial ports. The software that comes with the product can be used to configure these ports. Detailed information is provided in the Software User's Manual.

Pin Header J1/J3/J4/J6

DCD	1
RxD	2
TxD	3
DTR	4
GND	5
DSR	6
RTS	7
CTS	8

Male DB9 Port

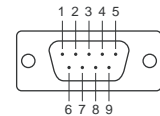

Pin	RS-232	RS-422	4-wire RS-485	2-wire RS-485
1	DCD	TxDA(-)	TxDA(-)	---
2	RxD	TxDB(+)	TxDB(+)	---
3	TxD	RxDB(+)	RxDB(+)	DataB(+)
4	DTR	RxDA(-)	RxDA(-)	DataA(-)
5	GND	GND	GND	GND
6	DSR	---	---	---
7	RTS	---	---	---
8	CTS	---	---	---

Console Ports

The EM-1240 embedded module has 1 serial console port for onsite configuration. However, it can also be used as an RS-232 serial port. Detailed information is provided in the Software User's Manual.

Male DB9 Port

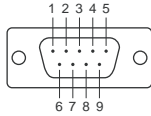

J5 Console Port



LAN Ports

The EM-1240 embedded module has 2 LAN ports that support 10/100 Mbps. The communication redundancy provided by the 2 LAN ports is useful for avoiding network failure.

8-pin RJ45

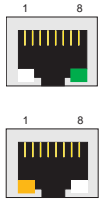

Pin	Signal
1	ETx+
2	ETx-
3	ERx+
4	---
5	---
6	ERx-
7	---
8	---

SD Socket

The EM-1240 Development Kit has an internal SD socket for storage expansion. The SD socket allows users to plug in a Secure Digital (SD) memory card that is compliant with the SD 1.0 standard to provide up to 1 GB of additional memory space. When removing the SD card from the socket, press in the SD card first to cause it to pop out. Detailed information is provided in the Software User's Manual.

GPIO

The EM-1240 Development Kit has 10 GPIOs. Digital input channels and digital output channels can be configured by software. Note that the GPIO function will not work if you enable the SD signals. Use the GPIO pin header to connect to devices. The GPIO pinouts are shown in the following figure.

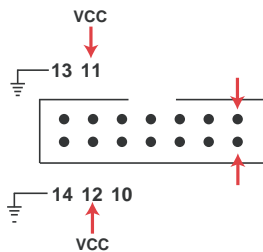

Connecting the Power

You may use either 5 VAC power or use the terminal block to provide power. Use the power switch to turn on and turn off the Development Kit.

Reset Button

Press the **Reset** button on the EM-1240-DK continuously for at least 5 seconds to load the factory default configuration. After the factory default configuration has been loaded, the system will reboot automatically. We recommend that you only use this function if the software is not working properly and you want to load factory default settings. To reset an embedded Linux system, always use the software reboot command `/>reboot` to protect the integrity of data being transmitted or processed. The Reset button is not designed to hard reboot the EM-1240 Development Kit.

7. Software Installation Procedure

STEP 1: Insert the EM-1240 CD-ROM into your Windows or Linux PC. Use Acrobat Reader to view the EM-1240 User's Manual.

STEP 2: Install the EM-1240 tool chain, which is on the CD-ROM. The tool chain consists of the following components:

- UC Finder:** Broadcast search for the EM-1240 IP address on your LAN. The EM-1240 supports the Linux platform.
- Cross Compiler:** Arm-elf-gcc is a C/C++ PC Cross Compiler, which is a gcc compiler that runs on an x86 PC, but creates an execution file for Arm-based platforms (such as the EM-1240). For more information visit <http://www.uclinux.org>.
- uClibc:** uClibc is an abbreviation for "microcontroller C library." uClibc was created to support μ CLinux, a Linux port for MMU-less microcontrollers, such as the ARM9 installed in the EM-1240. For more information, visit <http://www.uclibc.org>.

STEP 3: Edit source code on a Linux PC.

STEP 4: Use the Cross Compiler to compile the source code, and then use FTP to download the program to the EM-1240.

STEP 5: Run your program.

8. EM-1240 Hardware Specifications

Model	EM-1240 Embedded Module
CPU	Moxa ART ARM9 32-bit 192 MHz processor
RAM	16 MB
Flash	8 MB
LAN	Auto-sensing 10/100 Mbps \times 2 Built-in 1.5 KV magnetic isolation
Serial Ports	4 serial ports that support RS-232/422/485 signals
RS-232:	TxD, RxD, DTR, DSR, RTS, CTS, DCD, GND
RS-422:	TxD+, TxD-, RxD+, RxD-, GND
4-wire RS-485:	TxD+, TxD-, RxD+, RxD-, GND
2-wire RS-485:	Data+, Data-, GND
Serial Protection:	15 KV ESD for all signals

Data bits:	5, 6, 7, 8
Stop bits:	1, 1.5, 2
Parity:	None, even, odd, space, mark
Flow Control:	RTC/CTS, XON/XOFF
Speed:	50 bps to 921.6 Kbps, support any baudrate

Serial Console	RS-232 \times 1 (supports full signals and PPP)
Storage Expansion	SD signals for external Secure Digital (SD) socket connection

GPIO	GPIO \times 10 (to enable GPIO, SD must be disabled)
-------------	--

Real-time Clock Yes

Watchdog Timer Yes

Buzzer Signals Buzzer signals reserved for external buzzer connection

LED Signals System: Ready \times 1
LAN: 10M/Link \times 2, 100M/Link \times 2
Serial: TxD \times 4, RxD \times 4

Reset Signal Reserve signal for external "Reset to Default" button connection

Power Input Accept external 5 VDC through pin header

Dimensions (W \times L) 90 \times 80 mm

Operating Temperature -10 to 60°C (14 to 141°F), 5 to 95% RH

Storage Temperature -20 to 80°C (-4 to 176°F), 5 to 95% RH

Module Interface Two 2 \times 28 pin-headers, pitch: 1.27 \times 1.27 (mm)

MOXA

Click here for online support:
www.moxa.com/support

The Americas: +1-714-528-6777 (toll-free: 1-888-669-2872)
Europe: +49-89-3 70 03 99-0
Asia-Pacific: +886-2-8919-1230
China: +86-21-5258-9955 (toll-free: 800-820-5036)

© 2008 Moxa Inc., all rights reserved.
Reproduction without permission is prohibited.