

AWK-3131A Series Quick Installation Guide

Moxa AirWorks

Version 9.1, October 2022

Technical Support Contact Information
www.moxa.com/support

MOXA[®]

© 2022 Moxa Inc. All rights reserved.

P/N: 180203131101B



Table of Contents

Overview	- 3 -
Hardware Setup	- 3 -
Package Checklist	- 3 -
Panel Layout of the AWK-3131A	- 4 -
Mounting Dimensions	- 5 -
DIN-rail Mounting	- 5 -
Wall Mounting (Optional)	- 6 -
Wiring Requirements	- 7 -
Read and Follow These Guidelines:	- 7 -
Grounding the AWK-3131A	- 8 -
Installations with Cable Extended Antennas for Outdoor Applications	- 8 -
Wiring the Redundant Power Inputs	- 9 -
Wiring the Relay Contact	- 10 -
Wiring the Digital Inputs	- 10 -
Cable Holder Installation	- 10 -
Communication Connections	- 11 -
10/100BaseT(X) Ethernet Port Connection	- 11 -
1000BaseT Ethernet Port Connection	- 11 -
RS-232 Connection	- 11 -
LED Indicators	- 12 -
Specifications	- 13 -
Standards and Certifications	- 14 -
Special Conditions for Safe Use	- 15 -
Software Setup	- 16 -
How to Access the AWK	- 16 -
First-time Quick Configuration	- 16 -
Point-to-multipoint Scenario (AP/Client Mode)	- 17 -
Point-to-point Scenario (Master/slave mode)	- 19 -

Overview

The AWK-3131A 3-in-1 industrial wireless access point meets the growing need for faster data transmission speeds and wider coverage by supporting IEEE 802.11n technology with a net data rate of up to 300 Mbps. The AWK-3131A combines two adjacent 20 MHz channels into a single 40 MHz channel to deliver a potent combination of greater reliability and more bandwidth. The two redundant DC power inputs increase the reliability of the power supply, and the AWK-3131A can be powered via PoE to make deployment easier. The AWK-3131A can operate on either the 2.4 or the 5 GHz band and is backwards-compatible with existing 802.11a/b/g deployments.

Hardware Setup

This section covers the hardware setup for the AWK-3131A.

Package Checklist

Moxa's AWK-3131A is shipped with the following items. If any of these items is missing or damaged, please contact your customer service representative for assistance.

- 1 AWK-3131A wireless AP/client
- 2 2.4/5 GHz antennas: ANT-WDB-ARM-0202
- DIN-rail kit
- 2 plastic RJ45 protective caps
- Cable holder with one screw
- Quick installation guide (printed)
- Warranty card

Panel Layout of the AWK-3131A

Top Panel View

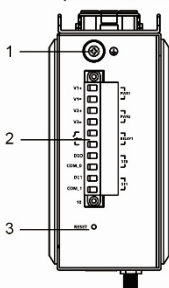

1. Grounding screw (M5)
2. Terminal block for PWR1, PWR2, relay, DI1, and DI2
3. Reset button
4. System LEDs: PWR1, PWR2, PoE, FAULT, and STATE LEDs
5. LEDs for signal strength
6. WLAN LED
7. Ethernet LED
8. RS-232 console port
9. LAN: 10/100/1000 BaseT(X) RJ45 Port
10. Antenna A
11. Antenna B
12. Model name
13. Screw holes for wall-mounting kit
14. DIN-rail mounting kit

Front Panel View

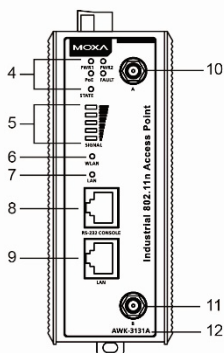

Rear Panel View

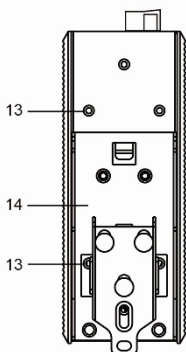

Mounting Dimensions

Unit = mm

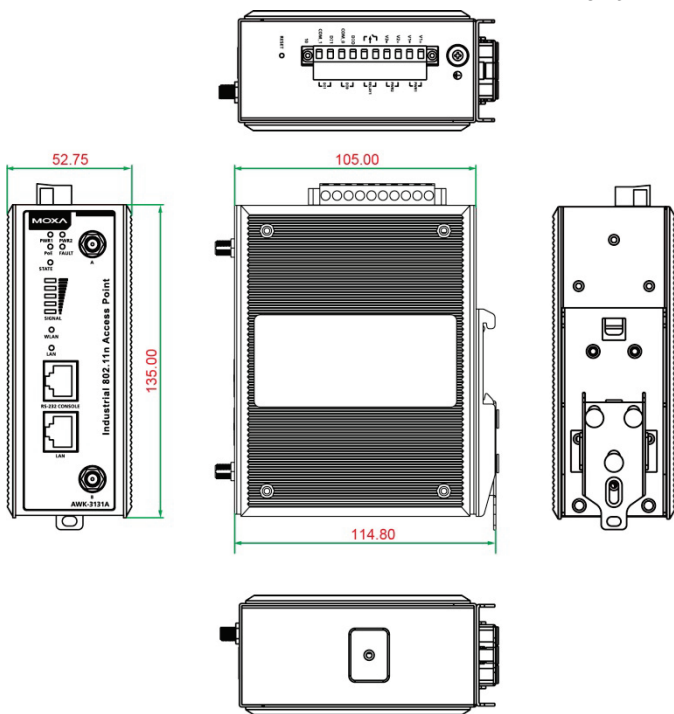

DIN-rail Mounting

When shipped, the metal DIN-rail mounting kit is fixed to the back panel of the AWK-3131A. Mount the AWK-3131A on to a corrosion-free mounting rail that adheres to the EN 60715 standard.

STEP 1:

Insert the upper lip of the DIN-rail kit into the mounting rail.

STEP 2:

Press the AWK-3131A towards the mounting rail until it snaps into place.

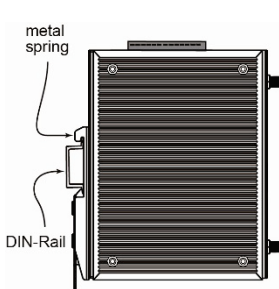
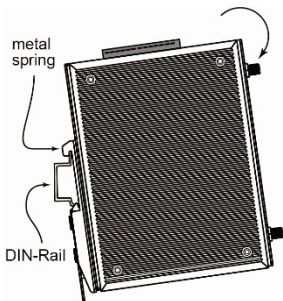

To remove the AWK-3131A from the DIN rail, do the following:

STEP 1:

Pull down the latch on the DIN-rail kit with a screwdriver.

STEP 2 & 3:

Slightly pull the AWK-3131A forward and lift it up to remove it from the mounting rail.

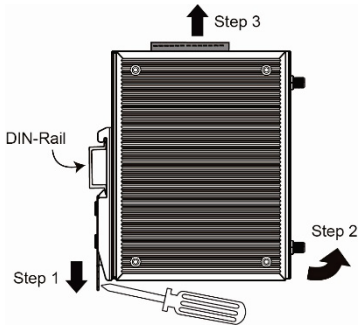

Wall Mounting (Optional)

For some applications, it may be more convenient to mount the AWK-3131A to a wall, as illustrated below.

STEP 1:

Remove the aluminum DIN-rail attachment plate from the AWK-3131A, and then attach the wall-mounting plates with M3 screws, as shown in the adjacent diagrams.

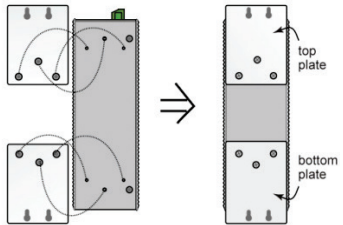

STEP 2:

Mounting the AWK-3131A to a wall requires 3 screws. Use the AWK-3131A device, with wall-mounting plates attached, as a guide to mark the correct locations of the 3 screws. The heads of the screws should be less than 6.0 mm in diameter, and the shafts should be less than 3.5 mm in diameter, as shown in the figure on the right.

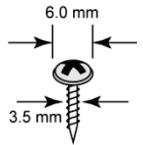

Do not drive the screws in all the way—leave a space of about 2 mm to allow room for sliding the wall-mounting panel between the wall and the screws.

NOTE Test the screw head and shank size by inserting the screws into one of the keyhole shaped apertures of the wall-mounting plates before they are fixed to the wall.

STEP 3:

Once the screws are fixed into the wall, insert the four screw heads through the large opening of the keyhole-shaped apertures, and then slide the AWK-3131A downwards, as indicated to the right. Tighten the three screws for added stability.

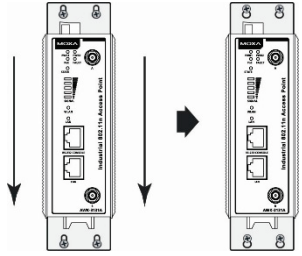

WARNING

- This equipment is intended to be used in a Restricted Access Location, such as a dedicated computer room where only authorized service personnel or users can gain access. Such personnel must be instructed about the fact that the metal chassis of the equipment is extremely hot and may cause burns.
- Service personnel or users have to pay special attention and take special precautions before handling this equipment.
- Only authorized, well-trained professionals should be allowed to access the restricted access location. Access should be controlled by the authority responsible for the location with lock and key or a security identity system.
- **External metal parts are hot!!** Pay special attention or use special protection before handling the equipment.

Wiring Requirements



WARNING

Safety First!

Be sure to disconnect the power cord before installing and/or wiring your AWK-3131A.

Calculate the maximum possible current in each power wire and common wire. Observe all electrical codes that dictate the maximum current allowed for each wire size. If the current goes above the maximum ratings, the wiring could overheat, causing serious damage to your equipment.

Read and Follow These Guidelines:

- Use separate paths to route wiring for power and devices. If power wiring and device wiring paths must cross, make sure the wires are perpendicular at the crossing point.

NOTE Do not run signal or communications wiring and power wiring in the same wire conduit. To avoid interference, wires with different signal characteristics should be routed separately.

- You can use the type of signal transmitted through a wire to determine which wires should be kept separate. The rule of thumb is that wiring that shares similar electrical characteristics can be bundled together.
- Keep input wiring and output wiring separated.
- For future reference, you should label the wiring used for all of your devices.



ATTENTION

This product is intended to be supplied by a Listed Power Unit marked "Class 2" or "LPS" and rated O/P: 7.2 W



ATTENTION

Make sure the external power adapter (includes power cords and plug assemblies) provided with the unit is certified and suitable for use in your country.



ATTENTION

DO NOT use a PoE Injector. Instead, use an IEEE 802.3af or IEEE 802.3at compliant PSE (Power Sourcing Equipment) for PoE (Power over Ethernet) devices.

Grounding the AWK-3131A

Grounding and wire routing help limit the effects of noise due to electromagnetic interference (EMI). Run the ground connection from the ground screw to the grounding surface prior to connecting devices.



ATTENTION

This product is intended to be mounted to a well-grounded mounting surface, such as a metal panel. The potential difference between any two grounding points must be zero. If the potential difference is NOT zero, the product could be permanently damaged.

Installations with Cable Extended Antennas for Outdoor Applications

If an AWK device or its antenna is installed in an outdoor location, proper lightning protection is required to prevent direct lightning strikes to the AWK device. In order to prevent the effects of coupling currents from nearby lightning strikes, a lightning arrester should be installed as part of your antenna system. Ground the device, antenna, as well as the arrester properly to provide maximum outdoor protection for the device.

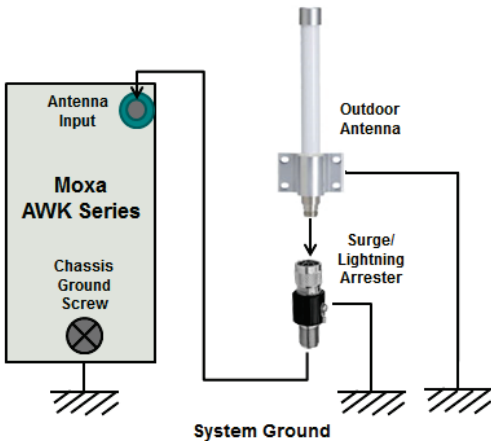

Arrester Accessories

- **SA-NMNF-01:** Surge arrester, N-type (male) to N-type (female)
- **SA-NFNF-01:** Surge arrester, N-type (female) to N-type (female)

Wiring the Redundant Power Inputs

The top two pairs of contacts of the 10-contact terminal block connector on the AWK-3131A's top panel are used for the AWK-3131A's two DC inputs. Top and front views of the terminal block connector are shown below.

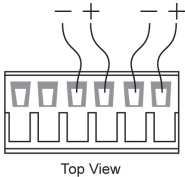

Top View

STEP 1: Insert the negative/positive DC wires into the V-/V+ terminals.

STEP 2: To keep the DC wires from pulling loose, use a small flat-blade screwdriver to tighten the wire-clamp screws on the front of the terminal block connector.

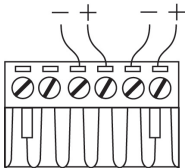

Front View

STEP 3: Insert the plastic terminal block connector prongs into the terminal block receptor, which is located on the AWK-3131A's top panel.

NOTE Input Terminal Block (CN1) is suitable for wire size range of 12-28 AWG (3.31-0.0804 mm²) and a torque value of 4.5 lb-in (0.51 Nm). The terminal block does not accommodate more than one individual conductor per clamping point and does not tolerate cable temperatures of 90.1°C or higher.



ATTENTION

If the AWK-3131A is connected to a motor or other similar type of equipment, be sure to use power isolation protection. Before connecting the AWK-3131A to the DC power inputs, make sure the DC power source voltage is stable.

Wiring the Relay Contact

The AWK-3131A has one relay output, which consists of the two contacts of the terminal block on the AWK-3131A's top panel. Refer to the previous section for detailed instructions on how to connect the wires to the terminal block connector, and how to attach the terminal block connector to the terminal block receptor. These relay contacts are used to indicate user-configured events. The two wires attached to the Relay contacts form an open circuit when a user-configured event is triggered. If a user-configured event does not occur, the Relay circuit will be closed.

Wiring the Digital Inputs

The AWK-3131A has two sets of digital inputs—DI1 and DI2. Each DI comprises two contacts of the 10-pin terminal block connector on the AWK-3131A's top panel. Refer to the "Wiring the Redundant Power Inputs" section for detailed instructions on how to connect the wires to the terminal block connector, and how to attach the terminal block connector to the terminal block receptor.

Cable Holder Installation

Attach the cable holder to the bottom of the AWK-3131A to keep cabling neat and avoid accidents that result from untidy cables.

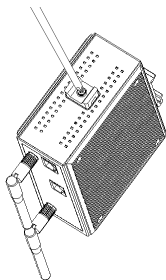

STEP 1: Screw the cable holder onto the bottom of the AWK-3131A.

STEP 2: After mounting the AWK-3131A and plugging in the LAN cable, tighten the cable along the device and wall.

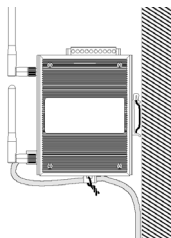
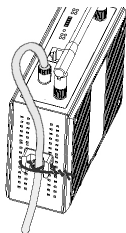
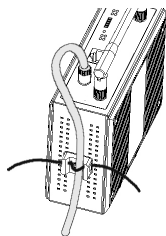

Communication Connections

10/100BaseT(X) Ethernet Port Connection

The 10/100BaseT(X) ports located on the AWK-3131A's front panel are used to connect to Ethernet-enabled devices.

Below we show pinouts for both MDI (NIC-type) ports and MDI-X (HUB/switch-type) ports.

MDI Port Pinouts

Pin	Signal
1	Tx+
2	Tx-
3	Rx+
6	Rx-

MDI-X Port Pinouts

Pin	Signal
1	Rx+
2	Rx-
3	Tx+
6	Tx-

8-pin RJ45

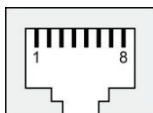

1000BaseT Ethernet Port Connection

1000BaseT data is transmitted on differential TRD+/- signal pairs over copper wires.

MDI/MDI-X Port Pinouts

Pin	Signal
1	TRD(0)+
2	TRD(0)-
3	TRD(1)+
4	TRD(2)+
5	TRD(2)-
6	TRD(1)-
7	TRD(3)+
8	TRD(3)-

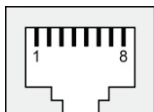

RS-232 Connection

The AWK-3131A has one RS-232 (8-pin RJ45) console port located on the front panel. Use either an RJ45-to-DB9 or RJ45-to-DB25 cable to connect the AWK-3131A's console port to your PC's COM port. You may then use a console terminal program to access the AWK-3131A for console configuration.

Console Pinouts for 10-pin or 8-pin RJ45 Ports

10-Pin	Description	8-Pin
1	-	
2	DSR	1
3	RTS	2

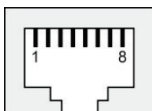

4	GND	3
5	TxD	4
6	RxD	5
7	DCD	6
8	CTS	7
9	DTR	8
10	-	

- NOTE**
1. The pin numbers for DB9 and DB25 male connectors, and hole numbers for DB9 and DB25 female connectors are labeled on the connector strip. However, the numbers are typically quite small, so you may need to use a magnifying glass to see the numbers clearly.
 2. The pin numbers for both the 8-pin and 10-pin RJ45 connectors (and ports) are typically not labeled on the connector (or port). Refer to the pinout diagram above for details.

LED Indicators

The front panel of the AWK-3131A contains several LED indicators. The function of each LED is described in the table below:



LED	Color	State	Description
Front Panel LED Indicators (System)			
PWR1	Green	On	Power is on (power input 1)
		Off	Power is not being supplied.
PWR2	Green	On	Power is on (power input 2)
		Off	Power is not being supplied.
PoE	Amber	On	Power is being supplied via the PoE.
		Off	Power is not being supplied via PoE.
FAULT	Red	On	System is booting up, or a system configuration error or relay event has occurred.
		Blinking (fast at 0.5-second intervals)	Cannot get an IP address from the DHCP server.
		Blinking (slow at 1-second intervals)	IP address conflict
		Off	Error condition does not exist.
STATE	Green	On	System startup is complete and the system is in operation.
		Blinking (fast at 0.5-second intervals)	AeroLink Protection is enabled and is currently in "Backup" state.
		Blinking (slow at 1-second intervals)	Device has been located by Wireless Search Utility
	Red	On	System is booting up

SIGNAL (5 LEDs)	Green	On	Wi-Fi Signal Level (for client/slave/ client-router modes only)
		Off	
WLAN	Green	On	WLAN function is in client/slave/ client-router mode and has established a link with an AP.
		Blinking	WLAN data transmission is in client/slave/client-router mode.
		Off	WLAN is not in client/slave/ client-router mode or has not established a link with an AP.
	Amber	On	WLAN is in AP/master mode.
		Blinking	WLAN data transmission is in AP/master mode.
		Off	WLAN is not in use or not working properly

LED	Color	State	Description
LAN	Green	On	LAN port's 1000 Mbps link is active .
		Blinking	Data is being transmitted at 1000 Mbps.
		Off	LAN port's 1000 Mbps link is inactive .
	Amber	On	LAN port's 10/100 Mbps link is active .
		Blinking	Data is being transmitted at 10/100 Mbps.
		Off	LAN port's 10/100 Mbps link is inactive .

Specifications

Input Current	0.6 A @ 12 VDC; 0.15 A @ 48 VDC PoE input: 48 VDC, 0.15 A Digital input: +13 to +30 VDC or +3 to -30 VDC, max. 8 mA Relay output: 24 VDC, 1 A
Input Voltage	12 to 48 VDC, redundant dual DC power inputs or 48 VDC Power-over-Ethernet (IEEE 802.3af compliant)
Power Consumption	7.2 W
Operating Temperature	Standard Models: -25 to 60°C (-13 to 140°F) Wide Temp. Models: -40 to 75°C (-40 to 167°F)
Storage Temperature	-40 to 85°C (-40 to 185°F)

ATEX information	
	
Ex II 3G DEMKO 15 ATEX 1543X Ex ec IIC T4 Gc Rated Cable Temp ≥ 90.1°C	

IECEX Cert. Number	IECEX UL 15.0085X
Address of manufacturer	No. 1111, Heping Rd., Bade Dist., Taoyuan City 334004, Taiwan

Standards and Certifications

Hazardous Location	EN IEC 60079-0:2018/IEC 60079-0 Ed.7 EN IEC 60079-7:2015+A1:2018/IEC 60079-7 Ed.5.1
--------------------	--



ATTENTION

The AWK-3131A is NOT a portable mobile device and should be located at least 20 cm away from the human body.

The AWK-3131A is NOT designed for the general public. To ensure that your AWK-3131A wireless network is safe and configured correctly, consult a well-trained technician to assist with the installation process.



ATTENTION

Use the appropriate antennas for your wireless setup: Use 2.4 GHz antennas when the AWK-3131A is configured for IEEE 802.11b/g/n. Use 5 GHz antennas when the AWK-3131A is configured for IEEE802.11a/n. Make sure that the antennas are located in an area with a lightning and surge protection system installed.



ATTENTION

This device complies with part 15 of the FCC Rules. Operation is subject to the following two conditions:

1. This device may not cause harmful interference.
2. This device must accept any interference received, including interference that may cause undesired operation.



ATTENTION

Do not locate the antenna near overhead power lines or other electric light or power circuits, or where it can come into contact with such circuits. When installing the antenna, take extreme care not to come into contact with such circuits, because they may cause serious injury or death. For proper installation and grounding of the antenna, refer to national and local codes (for example, U.S.: NFPA 70; National Electrical Code (NEC) Article 810; Canada: Canadian Electrical Code, Section 54).

NOTE For installation flexibility, either the A antenna (on the front panel) or the B antenna (on the top panel) may be selected for use. Make sure the antenna connection matches the antennas configured in the AWK-3131A web interface.

To protect the connectors and RF module, all radio ports should be terminated by either an antenna or a terminator. We strongly recommend using resistive terminators for terminating the unused antenna ports.



ATTENTION

When the AWK-3131A is installed in an enclosure, the antennas must remain internal to the enclosure and not external. External antenna deployment is allowed only if the antennas are certified by C1D2, ATEX Zone 2 or IECEx.

The AWK-3131A devices are open-type devices that are provided with a tool-removable cover or door that make these devices suitable for installation inside an enclosed environment.

This equipment is suitable for use only in Class I, Division 2, Groups A, B, C, and D or non-hazardous locations.



WARNING

EXPLOSION HAZARD

Do not disconnect equipment unless power has been removed or the area is known to be non-hazardous.



WARNING

EXPLOSION HAZARD

Substitution of any component may impair suitability for Class I, Division 2.



ATTENTION

ANATEL Statements

Este equipamento não tem direito à proteção contra interferência prejudicial e não pode causar interferência em sistemas devidamente autorizados. Para maiores informações, consulte o site da ANATEL – <https://www.gov.br/anatel>

Special Conditions for Safe Use

The equipment shall be installed in an enclosure that provides a degree of protection not less than IP54 and accessible only by the use of a tool in accordance with IEC/EN 60079-0. Subject devices are for use in an area of not more than pollution degree 2 in accordance with IEC/EN 60664-1.

Software Setup

This section covers the software setup for the AWK-3131A.

How to Access the AWK

Before installing the AWK device (AWK), make sure that all items in the package checklist are provided in the product box. You will also need access to a notebook computer or PC equipped with an Ethernet port.

- **Step 1: Select a suitable power source and plug in the AWK.**

The AWK can be powered by DC power ranging from **12 VDC to 48 VDC** or by a **PoE PSE** via an Ethernet connection.

- **Step 2: Connect the AWK to the notebook or PC via the AWK's LAN port.**

The LED indicator on the AWK's LAN port will light up when a connection is established.



NOTE If you are using an Ethernet-to-USB adapter, follow the instructions in the user's manual provided with the adapter.

- **Step 3: Set up the computer's IP address**

Choose an IP address for the computer that is on the same subnet as the AWK. Since the AWK's default IP address is **192.168.127.253**, and the subnet mask is **255.255.255.0**, set the IP address to **192.168.127.xxx**, where xxx is a value between 1 and 252.

- **Step 4: Access the homepage of the AWK.**

Open your computer's web browser and type **http://192.168.127.253** in the address field to access the AWK's homepage. Log in using the following default username and password:

Default Username: **admin**

Default Password: **moxa**

Click the **Login** button to access the homepage of the AWK device.

First-time Quick Configuration

After successfully accessing the AWK, refer to the appropriate subsection below to quickly set up a wireless network.

NOTE Ensure that there are no IP address conflicts when you configure more than one AWK on the same subnet.

Point-to-multipoint Scenario (AP/Client Mode)

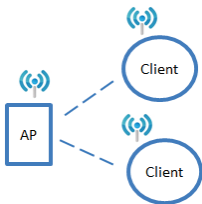

Configuring the AWK as an AP

- **Step 1: Set the operation mode of the AWK to AP mode.**

Go to **Wireless LAN Setup** → **Operation Mode** and select AP.

Operation Mode

Wireless enable Enable Disable

Operation mode

Submit

NOTE The default operation mode for the AWK is AP.

- **Step 2: Set up your own SSID.**

Go to **Wireless LAN Setup** → **WLAN** → **Basic WLAN Setup** and click **Edit** to set the SSID.

Basic WLAN Setup (Multiple SSID)

Status	SSID	Operation Mode	Action
Active	MOXA	AP	Edit

Add SSID

Basic WLAN Setup

Operation mode AP

RF type B/G/N Mixed

Channel 6

Channel width 20 MHz

SSID MOXA

SSID broadcast Enable Disable

Submit

NOTE The default SSID is MOXA.

- **Step 3: Set the RF type and Channel for the AWK.**

Go to **Wireless LAN Setup** → **WLAN** → **Basic WLAN Setup**.

We recommend that you choose the RF type 5 GHz for a relative clean medium with minimum interference.

The screenshot shows the 'Basic WLAN Setup' page. The 'Operation mode' is set to 'AP'. The 'RF type' dropdown menu is open, showing options: B/G/N Mixed, 2.4GHz, B, G, B/G Mixed, G/N Mixed, B/G/N Mixed, N Only (2.4GHz), 5GHz, A, A/N Mixed, and N Only (5GHz). The 'Channel' dropdown menu is also open, showing options: 2.4GHz, B, G, B/G Mixed, G/N Mixed, B/G/N Mixed, N Only (2.4GHz), 5GHz, A, A/N Mixed, and N Only (5GHz). The '5GHz' option is highlighted in blue. A 'Submit' button is visible at the bottom left.

For the **Channel** setting, we recommend that you choose a channel other than the default channel to avoid interference.

The screenshot shows the 'Basic WLAN Setup' page. The 'Operation mode' is set to 'AP'. The 'RF type' is set to 'N Only (5GHz)'. The 'Channel' dropdown menu is open, showing options: 36, 40, 44, 48, 52, 56, 60, 64, 68, 72, 76, 80, 84, 88, 92, 96, 100, 104, 108, 112, 116, 120, 124, 128, 132, 136, 140, 144, 148, 152, 156, 160, 164, 168, 172, 176, 180, 184, 188, 192, 196, 200, 204, 208, 212, 216, 220, 224, 228, 232, 236, 240, 244, 248, 252, 256, 260, 264, 268, 272, 276, 280, 284, 288, 292, 296, 300, 304, 308, 312, 316, 320, 324, 328, 332, 336, 340, 344, 348, 352, 356, 360, 364, 368, 372, 376, 380, 384, 388, 392, 396, 400, 404, 408, 412, 416, 420, 424, 428, 432, 436, 440, 444, 448, 452, 456, 460, 464, 468, 472, 476, 480, 484, 488, 492, 496, 500, 504, 508, 512, 516, 520, 524, 528, 532, 536, 540, 544, 548, 552, 556, 560, 564, 568, 572, 576, 580, 584, 588, 592, 596, 600, 604, 608, 612, 616, 620, 624, 628, 632, 636, 640, 644, 648, 652, 656, 660, 664, 668, 672, 676, 680, 684, 688, 692, 696, 700, 704, 708, 712, 716, 720, 724, 728, 732, 736, 740, 744, 748, 752, 756, 760, 764, 768, 772, 776, 780, 784, 788, 792, 796, 800, 804, 808, 812, 816, 820, 824, 828, 832, 836, 840, 844, 848, 852, 856, 860, 864, 868, 872, 876, 880, 884, 888, 892, 896, 900, 904, 908, 912, 916, 920, 924, 928, 932, 936, 940, 944, 948, 952, 956, 960, 964, 968, 972, 976, 980, 984, 988, 992, 996, 1000. The '36' option is highlighted in blue. The 'Channel width' is set to '20 MHz'. The 'SSID' is set to 'MOXA'. The 'SSID broadcast' is set to 'Enable'. A 'Submit' button is visible at the bottom left.

Click **Submit** to apply the changes, and restart the AWK in AP mode to complete the configuration process.

Configuring the AWK as a Client

- **Step 1: Set the operation mode of the AWK to Client mode.**

Go to **Wireless LAN Setup** → **Operation Mode**, set the operation mode to Client, and then click **Submit** to apply the change.

The screenshot shows the 'Operation Mode' page. The 'Wireless enable' is set to 'Enable'. The 'Operation mode' dropdown menu is open, showing options: AP, AP, Client, Client-Router, Master, Slave, and Sniffer. The 'Client' option is highlighted in blue. A 'Submit' button is visible at the bottom left.

- **Step 2: Link to an existing SSID.**

Go to **Wireless LAN Setup** → **WLAN** → **Basic WLAN Setup** and click **Site Survey** to select an existing SSID, or directly enter an existing SSID in the text field.

The screenshot shows the 'Basic WLAN Setup' page. The 'Operation mode' is set to 'Client'. The 'RF type' is set to 'B/G/N Mixed'. The 'Channel width' is set to '20 MHz'. The 'SSID' is set to 'MOXA'. The 'Site Survey' button is visible at the bottom right. A 'Submit' button is visible at the bottom left.

- **Step 3: Set the RF type and Channel settings for the AWK.**

On the **Wireless LAN Setup** → **WLAN** → **Basic WLAN Setup** page, edit the RF type and Channel settings.

Click **Submit** to apply the changes, and restart the AWK in client mode to complete the configuration process.

Point-to-point Scenario (Master/slave mode)



Configuring the AWK as a Master

- **Step 1: Set the operation mode of the AWK to Master mode.**

Go to **Wireless LAN Setup** → **Operation Mode**, set the operation mode to **Master**, and then click **Submit** to apply the change.

- **Step 2: Set up your own SSID.**

Go to **Wireless LAN Setup** → **WLAN** → **Basic WLAN Setup** and click **Edit** to set the SSID.

- **Step 3: On the Wireless LAN Setup** → **WLAN** → **Basic WLAN Setup** page edit the RF type and Channel settings.

Click **Submit** to apply the changes, and restart the AWK in master mode to complete the configuration process.

Configuring the AWK as a Slave

- **Step 1: Set the operation mode of the AWK to Slave mode.**

Go to **Wireless LAN Setup** → **Operation Mode**, set the operation mode to **Slave**, and then click **Submit** to apply the change.

The screenshot shows a configuration interface for the AWK's operation mode. At the top, the title is "Operation Mode". Below it, there are two sections: "Wireless enable" and "Operation mode". In the "Wireless enable" section, there are two radio buttons: "Enable" (which is selected) and "Disable". In the "Operation mode" section, there is a dropdown menu that is currently open, displaying a list of options: "Slave", "AP", "Client", "Client-Router", "Master", "Slave" (which is highlighted with a blue background and a red border), and "Sniffer". To the left of the dropdown menu, there is a "Submit" button.

- **Step 2: Link to an existing SSID.**

Go to **Wireless LAN Setup** → **WLAN** → **Basic WLAN Setup** and click **Site Survey** to select an existing SSID, or directly enter an existing SSID in the text field.

- **Step 3: Set the RF type for the AWK.**

On the **Wireless LAN Setup** → **WLAN** → **Basic WLAN Setup** page edit the RF type setting.

Click **Submit** to apply the changes, and restart the AWK in slave mode to complete the configuration process.