

VPort 26 Series

IP66 day-and-night vandal-proof fixed dome IP cameras for outdoors



- > -40 to 50°C operating temperature; no heater or fan required
- > Maximum 800 x 600 (SVGA) resolution at 30 FPS
- > High quality video image with 3D-DNR, BLC, and WDR
- > 2.8 to 11 mm day-and-night vari-focal lens with a built-in removeable IR-cut filter (ICR)
- > Up to 0.01 lux illumination performance for color images
- > DynaStream™ supported for optimized network efficiency
- > ONVIF conformity for standardization and interoperability
- > 802.1X, HTTPS, and SSH supported for advanced network security



Introduction

The VPort 26 series is a vandal-proof, IP66-rated, fixed dome IP camera designed for outdoor use. With SVGA (max. 800 x 600) resolution, H.264/MJPEG 3 simultaneous video streams, and day-and-

night camera lens, the VPort 26 series is well-suited for outdoor video surveillance applications.

Good Video Quality

To enhance video image quality, the VPort 26 series is equipped with a 2.8 to 11 mm vari-focal lens that meets any viewing angle and distance requirements. With the built-in removeable IR-cut filter, and automatic switching from color to B/W images, the VPort 26 series is suitable for

day-and-night use. Along with the 3D-DNR (3D Digital Noise Reduction) function, which greatly reduce the noise from video frames, and WDR (Wide Dynamic Range), the VPort 26 series provides clear images under back light circumstances.

Rugged Hardware Design

The VPort 26 series is specially designed for outdoor applications with the following features: IP66 rain and dust protection, high EMI/surge protection, -40 to 50°C operating temperature without a fan or heater required, metal housing, and vandal-proof dome cover. In addition, the

camera is housed in a dehumidified membrane for spreading out the moisture inside the camera. You may choose either the PoE (Power over Ethernet, 802.3af) model, or a wire power input models with either 12/24 VDC or 24 VAC.

High Video Performance and Network Security

The VPort 26 series is designed to provide both H.264 and MJPEG video streams and transmit up to 3 independent video streams (H.264 x 2, MJPEG x 1) simultaneously. The camera can encode and transmit up to 30 FPS for each of the H.264 and MJPEG streams. Advanced

network security functions, such as 802.1x and SSH, are also provided to prevent unauthorized access or data hijacking, which is critical for most surveillance applications.

Specifications

Camera

Sensor: 1/3" SVGA progressive scan CMOS

Lens:

- Focal length= 2.8 to 11 mm
- Wide-end: F=1.4, Diagonal 125.2°, horizontal 97.1°, vertical 71.1°
- Tele-end: F=2.8, diagonal 31.6°, horizontal 25.3°, vertical 19.0°

Auto Iris Type: DC drive

Camera Angle:

Pan: ±175°; Tilt: 0 to 85°; Rotation: ±180°

Minimum illumination (low light sensitivity): 0.01 lux, F=1.2

Synchronization: Internal

Gamma Correction: 0.45

White Balance: ATW/AWB (range: 3200 to 10000°K)

S/N Ratio: 52dB (TYP) (Gamma, Aperture, AGC Off; 3D-DNR On)

ICR Control: Auto

DNR: Built-in 3D-DNR (3D digital noise reduction)

WDR: 94 dB, Level 1 to Level 9

De-mist: Off, low, medium, high

AGC Control: Level 1 to Level 9

Backlight Compensation: On/off with selectable areas

Digital Zoom: 4X

Auto Light Control: Level 1 to Level 8

Image Rotation: Flip, Mirror, and 180° rotation

Image Setting: Manual tuning with saturation and sharpness

Video

Video Compression: H.264 (ISO/IEC 14496-10) or MJPEG

Video Outputs: Via Ethernet

Video Streams: Maximum of 3 video streams (2 x H.264, 1 x MJPEG)

Video Resolution and FPS (frames per second):

	NTSC		PAL	
	Size	Max. FPS	Size	Max. FPS
QCIF	176 x 112	30	176 x 144	25
CIF	352 x 240	30	352 x 288	25
VGA	640 x 480	30	640 x 480	25
4CIF	704 x 480	30	704 x 576	25
Full D1	720 x 480	30	720 x 576	25
SVGA	800 x 600	30	800 x 600	25

Video Viewing:

- DynaStream™ supported for changing the video frame rate automatically
- 8 privacy mask areas provided
- Adjustable image size and quality
- Timestamp and text overlay
- Maximum of 10 simultaneous unicast connections

PTZ: Digital PTZ with 4X zoom

Audio Inputs: 1 line-in or mic-in with 2-pin terminal block connector

Audio Outputs: 1 line-out with 2-pin terminal block connector

Network

Protocols: TCP, UDP, HTTP, SMTP, FTP, Telnet, NTP, DNS, DHCP, UPnP, RTP, RTSP, ICMP, IGMPv3, QoS, SNMPv1/v2c/v3, DDNS, Modbus/TCP, 802.1X, SSH, HTTPS

Ethernet: 1 10/100BaseT(X) Ethernet port, RJ45 connector

GPIO

Digital Inputs: 1, max. 8 mA

Low: +13 V to +30 V; High: -30 V to +3 V

Relay Output: 1, max. 24 VDC @ 1A

LED Indicators

STAT: Indicates if the system is booted properly or not

Network: 10 Mbps or 100 Mbps

Power: Power on/off

DIP Switch: To turn the LED light on/off

Local Storage

SD Socket: Standard SD socket (SDHC)

Power Requirements

Power Input:

- VPort 26: 1, 12/24 VDC or 24 VAC
- VPort P26: Power-over-Ethernet (IEEE 802.3af)

Power Consumption: Max. 11.7 W

Physical Characteristics

Housing: Metal, IP66 rated for rain and dust protection

Dimensions: 149 mm (diameter) x 120 mm (height)

Installation: Surface mounting, or outdoor mounting with accessories

Security

Password: User level password protection

Filtering: By IP address

Authentication: 802.1X

Encryption: HTTPS, SSH

Alarms

Intelligent Video: Camera tamper (Pending)

Video Motion Detection: Includes sensitivity settings

Video Loss: Video loss alarm

Scheduling: Daily repeat timing schedule

Imaging: JPEG snapshots for pre/trigger/post alarm images

Email/FTP Messaging: Automatic transfer of stored images via email or FTP as event-triggered actions

Custom Alarms: HTTP event servers and CGI events for setting customized alarm actions

Pre-alarm Buffer: 24 MB video buffer for JPEG snapshot images

Environmental Limits

Operating Temperature: -40 to 50°C (-40 to 122°F)

Storage Temperature: -40 to 85°C (-40 to 185°F)

Ambient Relative Humidity: 5 to 95% (non-condensing)

Standards and Certifications

Safety: UL 60950-1

EMI: FCC Part 15, CISPR (EN 55022) class A

EMS:

EN 61000-4-2 (ESD), Level 3,

EN 61000-4-3 (RS), Level 3,

EN 61000-4-4 (EFT), Level 3,

EN 61000-4-5 (Surge), Level 3,

EN 61000-4-6 (CS), Level 3,

EN 61000-4-8,

EN 61000-4-11

Shock: IEC60068-2-27

Freefall: IEC60068-2-32

Vibration: IEC60068-2-6

Vandal Resistance: EN 62262, IK10 level

Note: Please check Moxa's website for the most up-to-date certification status.

Warranty

Warranty Period: 3 years

Details: See www.moxa.com/warranty

Minimum Viewing System Requirements

CPU: Pentium 4, 2.4 GHz

Memory: 512 MB of memory

OS: Windows XP/2000 with SP4 or above

Browser: Internet Explorer 6.x or above

Multimedia: DirectX 9.0c or above

Software Development Kit

VPort SDK PLUS: Includes CGI commands, ActiveX Control, and API library for customized applications or system integration for third-party developers (the latest version of SDK is available for download from Moxa's website).

Standard: ONVIF

Dimensions

Unit: mm (inch)

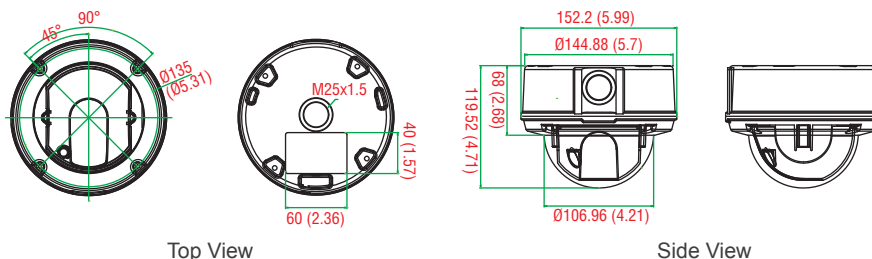

Ordering Information

Available Models

VPort 26: Outdoor H.264/MJPEG fixed dome IP camera, 12/24 VDC or 24 VAC power input, -40 to 50°C operating temperature

VPort P26: Outdoor H.264/MJPEG fixed dome IP camera, Power-over-Ethernet, -40 to 50°C operating temperature

Optional Accessories (can be purchased separately)

SoftNVR-IA V3.0: 64-channel IP surveillance software for industrial automation applications

DR-4524/75-24/120-24: 45/75/120 W DIN-Rail 24 VDC power supplies

MDR-40-24/60-24: 40/60 W DIN-Rail 24 VDC power supplies, -20 to 70°C operating temperature

VP-MK2: Mounting kit for the VPort 26 series



VP-520L: Wall mounting kit for mounting the VPort 26 on wall

VP-520HB: Pendant mounting kit for mounting the VPort 26 on ceiling

VP-CPM: Pole/corner mounting kit for mounting the VPort 26 on a pole or corner with the VP-520L

Package Checklist

- VPort 26 or VPort P26 IP camera
- Panel mount kit
- 4 self-tapping screws and anchors
- IP66 cable glands
- L-type Torx screw driver
- Quick installation guide (printed)
- Documentation and software CD
- Warranty card

Wall Mount	Pendant Mount	Pole Mount
VPort 26 + VP-MK2 + VP-520L	VPort 26 + VP-MK2 + VP-520HB	VP-CPM
		

Mounting Kit

For mounting the VPort 26 on a straight tube and pendant.

VP-MK2

Height: 69 mm (2.7 in)
Diameter: 160 mm (6.3 in)
Weight: 470 g

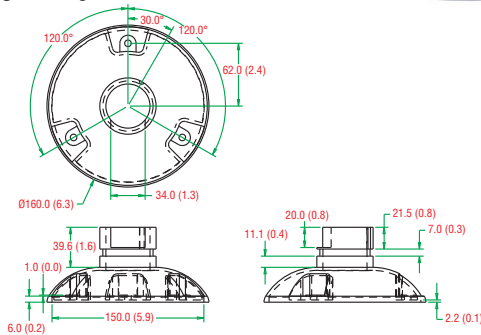

Wall Mounting Kit

For mounting the VPort 26 on a wall.

VP-520L

Height: 160 mm (6.3 in)
Width: 100 mm (3.9 in)
Depth: 210 mm (8.3 in)
Weight: 840 g

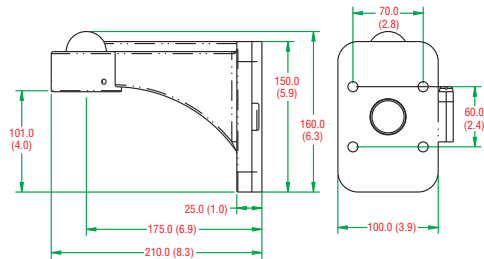

Pendant Mounting Kit

For mounting the VPort 26 on a ceiling.

VP-520HB

Height: 150 mm (5.9 in)
Width: 204 mm (8 in)
Depth: 244 mm (9.6 in)
Weight: 2.7 kg
Straight tube: 300 mm (11.8 in)

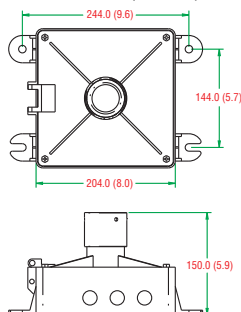

Pole/Corner Mounting Kit

For mounting VPort 26 on a pole or corner with the VP-520L.

VP-CPM

Height: 126 mm (5 in)
Width: 156.6 mm (6. in)
Depth: 86.8 mm (6.2 in)
Weight: 440 g
Stainless Strap: 2

