

# **EDS-G205-1GTXSFP Series Quick Installation Guide**

---

**Moxa EtherDevice Switch**

**Version 3.2, May 2023**

**Technical Support Contact Information**  
[www.moxa.com/support](http://www.moxa.com/support)

**MOXA®**

© 2023 Moxa Inc. All rights reserved.

**P/N: 1802002051034**



## Overview

The EDS-G205-1GTXSFP switches are equipped with 5 Gigabit Ethernet ports (4 10/100/1000BaseT(X) ports and 1 combo 10/100/1000BaseT(X) or 100/1000BaseSFP port), making them ideal, economical solutions for demanding, high bandwidth Gigabit Ethernet applications. In addition, the built-in relay warning function alerts system administrators when power failures or port breaks occur, and the add-on 4-pin DIP switches can be used to configure broadcast storm protection, jumbo frame rate, IEEE 802.3az energy saving, and 100/1000 SFP speed switching. The EDS-G205-1GTXSFP series includes 2 models: one with an operating temperature range of -10 to 60°C, and the other with an extended operating temperature range of -40 to 75°C. These 2 models have passed a 100% burn-in test to ensure that they fulfill the special needs of industrial automation control. The EDS-G205-1GTXSFP series can be easily installed on a DIN rail or in distribution boxes.

**NOTE** Throughout this Hardware Installation Guide, we use EDS as an abbreviation for Moxa EtherDevice Switch:

**EDS = Moxa EtherDevice Switch**

## Package Checklist

The EDS-G205-1GTXSFP is shipped with the following items.

- Moxa EDS-G205-1GTXSFP Switch
- Quick installation guide (printed)
- Warranty card

*Note: Please contact your customer service representative for assistance if any of these items are missing or damaged.*

## Features

### **High Performance Network Switching Technology**

- 10/100/1000BaseT(X) (RJ45), auto negotiation speed, F/H duplex mode
- IEEE 802.3/802.3u/802.3ab/802.3z
- 100BaseSFP/1000BaseSFP; easily configure speed by DIP switch
- Store and Forward switching process type, 8K MAC address entries.

### **Industrial Grade Reliability and Efficiency**

- Power failure, port break alarm by relay output
- Redundant dual 12/24/48 VDC power inputs
- IEEE 802.3az energy-efficient Ethernet settings by DIP switch
- Jumbo frame setting by DIP switch

### **Rugged Design**

- Operating temperature range of -10 to 60°C, or extended operating temperature of -40 to 75°C for T models
- IP30, rugged high-strength housing
- DIN rail or panel mounting capability

## Panel Layout of the EDS-G205-1GTXSFP

Front Panel View

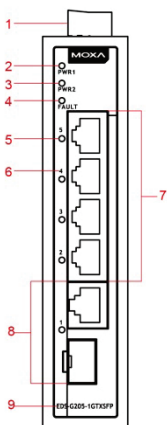

1. Terminal block for power input (PWR1, PWR2) and relay output
2. PWR1: LED for power input 1
3. PWR2: LED for power input 2
4. FAULT: LED indicator
5. 10/100/1000BaseT(X) LED indicator (Amber: 10/100M; Green: 1000M)
6. Port number
7. 2 to 5: 10/100/1000 BaseT(X) ports
8. 1: 10/100/1000 BaseT(X) or 100/1000Base SFP slot combo port
9. Model Name
10. Grounding screw
11. DIP switches
12. Screw hole for wall mounting kit
13. DIN rail kit

Top Panel View

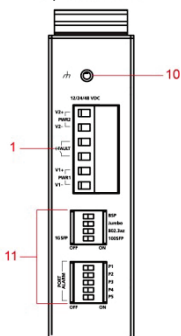

Rear Panel View

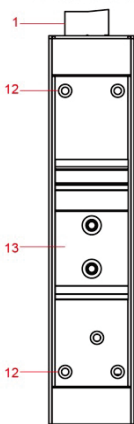

## Mounting Dimensions, unit = mm (inch)

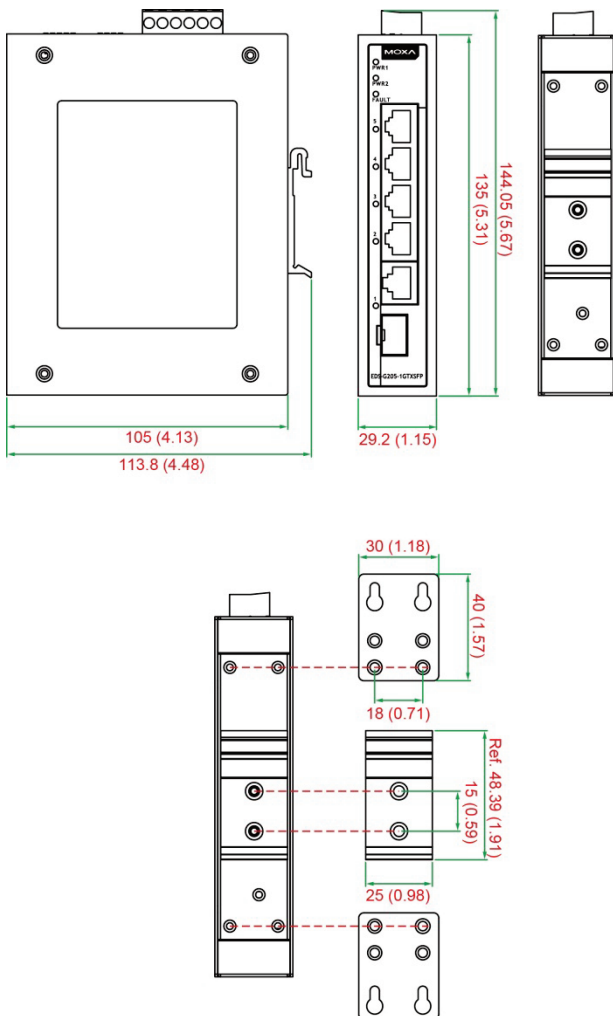

## DIN-rail Mounting

The aluminum DIN rail attachment plate which adheres to the EN 60715 standard, should already be fixed to the back panel of the switch when you take it out of the box. If you need to reattach the DIN rail attachment plate, make sure the stiff metal spring is situated towards the top, as shown in the figures below.

**STEP 1:**

Insert the top of the DIN rail into the slot just below the stiff metal spring.

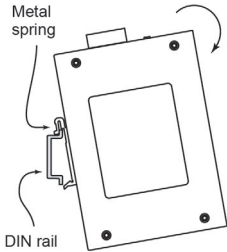
**STEP 2:**

The DIN rail attachment unit will snap into place as shown below.

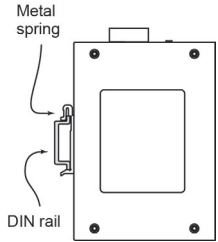

To remove the DIN rail from the switch, simply reverse Steps 1 and 2.

**Wall Mounting (optional)**

For some applications, you will find it convenient to mount the switch on the wall, as illustrated below.

**STEP 1:**

Remove the aluminum DIN rail attachment plate from the switch's rear panel, and then attach the wall mount plates, as shown in the figure.

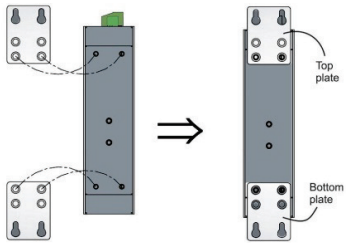
**STEP 2:**

Mounting the switch on the wall requires 4 screws. Use the switch, with wall mount plates attached, as a guide to mark the correct locations of the 4 screws. The heads of the screws should be less than 6.0 mm in diameter, and the shafts should be less than 3.5 mm in diameter, as shown in the figure at the right.

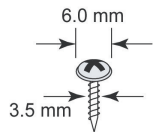

**NOTE** Before tightening the screws into the wall, make sure the screw head and shank size are suitable by inserting the screw into one of the keyhole-shaped apertures of the wall mounting plates.

Do not screw the screws in all the way—leave about 2 mm to allow room for sliding the wall mount panel between the wall and the screws.

### STEP 3:

Once the screws are fixed in the wall, insert the four screw heads through the large parts of the keyhole-shaped apertures, and then slide the switch downwards, as indicated. Tighten the four screws for added stability.

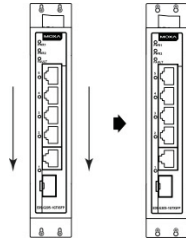

## Wiring Requirements



### WARNING

#### Safety First!

Turn the power off before disconnecting modules or wires. The proper power supply voltage is listed on the product label. Check the voltage of your power source to make sure you are using the correct voltage. Do NOT use a voltage greater than what is specified on the product label.

These devices must be supplied by an SELV source as defined in the Low Voltage Directive 2006/95/EC and 2004/108/EC.



### WARNING

#### Safety First!

Calculate the maximum possible current in each power wire and common wire. Observe all electrical codes dictating the maximum current allowable for each wire size.

If the current goes above the maximum ratings, the wiring could overheat, causing serious damage to your equipment.

You should also pay attention to the following items:

- Use separate paths to route wiring for power and devices. If power wiring and device wiring paths must cross, make sure the wires are perpendicular at the intersection point.  
**NOTE:** Do not run signal or communications wiring and power wiring in the same wire conduit. To avoid interference, wires with different signal characteristics should be routed separately.
- You can use the type of signal transmitted through a wire to determine which wires should be kept separate. The rule of thumb is that wiring with similar electrical characteristics can be bundled together.
- Keep input wiring and output wiring separated.
- We strongly advise labeling the wiring for all devices in the system.

## Grounding Your Moxa Switch

Grounding and wire routing help limit the effects of noise due to electromagnetic interference (EMI). Run the ground connection from the ground screw to the grounding surface prior to connecting devices.

The cross sectional area of the ground wires should be at least 3.31 mm<sup>2</sup>.



## ATTENTION

This product is intended to be mounted to a well-grounded mounting surface, such as a metal panel.

## Wiring the Alarm Contact

The alarm contact consists of the two middle contacts of the terminal block on the switch's top panel. You may refer to the next section for detailed instructions on how to connect the wires to the terminal block connector, and how to attach the terminal block connector to the terminal block receptor.

In this section, we explain the meaning of the two contacts used to connect the alarm contact.

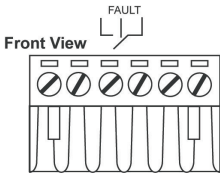
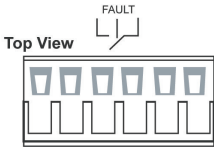

**FAULT:** The two middle contacts of the 6-contact terminal block connector are used to detect both power faults and port faults. The two wires attached to the Fault contacts form an open circuit when:

1. The switch has lost power from one of the DC power inputs.  
OR
2. The PORT ALARM DIP switch for one of the ports is set to ON, but the port is not connected properly.

If neither of these two conditions is satisfied, the Fault circuit will be closed.

## Wiring the Redundant Power Inputs

The top two contacts and the bottom two contacts of the 6-contact terminal block connector on the switch's top panel are used for DC inputs. Top and front views of one of the terminal block connectors are shown here.

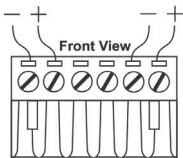
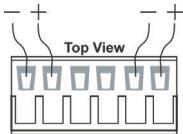

**STEP 1:** Insert the negative/positive DC wires into the V-/V+ terminals.

**STEP 2:** To keep the DC wires from pulling loose, use a small flat-blade screwdriver to tighten the wire-clamp screws on the front of the terminal block connector.

**STEP 3:** Insert the plastic terminal block connector prongs into the terminal block receptor, which is located on switch's top panel.



## ATTENTION

Before connecting the switch to the DC power inputs, make sure the DC power source voltage is stable.

You should also pay attention to the following:

- The terminal block plug must be suitable for 24-12 AWG (0.2 to 4.0 mm<sup>2</sup>) wiring; use a torque value of 4.5 lb-in.
- The recommended cable stripping length is 7 to 8 mm.
- Only use one individual conductor at each clamping point.

## Communication Connections

EDS-G205-1GTXSFP switches have 2 types of communication port:

- 4 10/100/1000BaseT(X) Ethernet ports
- 1 combination 10/100/1000T(X) or 100/1000BaseSFP port

### 10/100/1000BaseT(X) Ethernet Port Connection

The 10/100/1000BaseT(X) ports located on switch's front panel are used to connect to Ethernet-enabled devices. Most users will choose to configure these ports for Auto MDI/MDI-X mode, in which case the port's pinouts are adjusted automatically depending on the type of Ethernet cable used (straight-through or cross-over), and the type of device (NIC-type or HUB/Switch-type) connected to the port.

In what follows, we give pinouts for both MDI (NIC-type) ports and MDI-X (HUB/Switch-type) ports. We also give cable wiring diagrams for straight-through and cross-over Ethernet cables.

#### 10/100BaseT(x) RJ45 Pinouts

**MDI Port Pinouts**

Pin	Signal
1	Tx+
2	Tx-
3	Rx+
6	Rx-

**MDI-X Port Pinouts**

Pin	Signal
1	Rx+
2	Rx-
3	Tx+
6	Tx-

**8-pin RJ45**

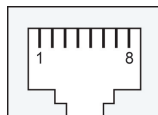

#### 1000BaseT RJ45 Pinouts

Pin	MDI	MDI-X
1	BI_DA+	BI_DB+
2	BI_DA-	BI_DB-
3	BI_DB+	BI_DA+
4	BI_DC+	BI_DD+
5	BI_DC-	BI_DD-
6	BI_DB-	BI_DA-
7	BI_DD+	BI_DC+
8	BI_DD-	BI_DC-

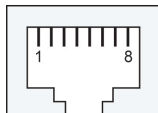



## RJ45 (8-pin) to RJ45 (8-pin) Straight-Through Cable Wiring

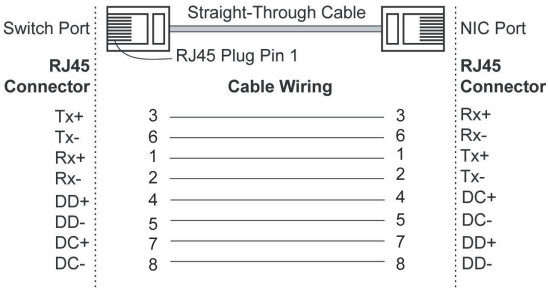

## RJ45 (8-pin) to RJ45 (8-pin) Cross-Over Cable Wiring

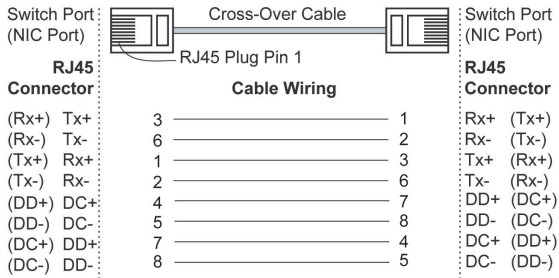

## **100/1000BaseSFP (mini-GBIC) Fiber Port**

One of the Gigabit Ethernet ports on the EDS-G205-1GTXSFP is an SFP slot, which requires 100M or 1G mini-GBIC fiber transceivers to work properly. Moxa provides complete transceiver models for various distance requirements.

The concept behind the LC port and cable is straightforward. Suppose you are connecting devices I and II. Unlike electrical signals, optical signals do not require a circuit in order to transmit data. Consequently, one of the optical lines is used to transmit data from device I to device II, and the other optical line is used to transmit data from device II to device I, for full-duplex transmission.

Remember to connect the Tx (transmit) port of device I to the Rx (receive) port of device II, and the Rx (receive) port of device I to the Tx (transmit) port of device II. If you make your own cable, we suggest labeling the two sides of the same line with the same letter (A-to-A and B-to-B, as shown below, or A1-to-A2 and B1-to-B2).

### **LC-Port Pinouts**

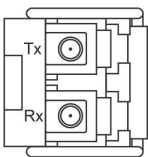

### **LC-Port to LC-Port Cable Wiring**

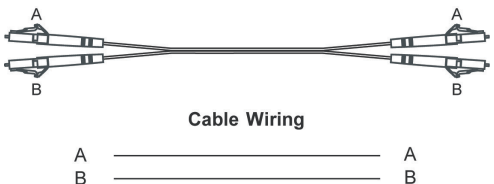



## ATTENTION

This is a Class 1 Laser/LED product. To avoid causing serious damage to your eyes, do not stare directly into the laser beam.

## Redundant Power Inputs

Both power inputs can be connected simultaneously to live DC power sources. If one power source fails, the other live source acts as a backup, and automatically supplies all of the switch's power needs.

## Alarm Contact

The EDS-G205-1GTXSFP has one alarm contact located on the top panel. For detailed instructions on how to connect the alarm contact power wires to the two middle contacts of the 6-contact terminal block connector, see the **Wiring the Alarm Contact** section on page 7. A typical scenario would be to connect the Fault circuit to a warning light located in the control room. The light can be set up to switch on when a fault is detected.

The alarm contact has two terminals that form a Fault circuit for connecting to an alarm system. The two wires attached to the Fault contacts form an open circuit when (1) the switch has lost power from one of the DC power inputs, or (2) one of the ports, for which the corresponding PORT ALARM DIP switch is set to ON, is not properly connected.

If neither of these two conditions occurs, the Fault circuit will be closed.

## DIP Switch Settings

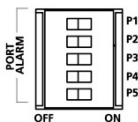
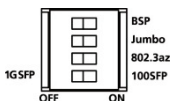

The default setting for each DIP switch is OFF. The following table explains the effect of setting the DIP switches to the ON positions.

**NOTE** The switch will only check the functions of the DIP switch when the switch is powered on. If you want to change the functions of the DIP switch, you must restart the switch.

DIP Switch	Setting	Description
BSP	ON	Enables broadcast storm protection
	OFF	Disables broadcast storm protection
Jumbo Frame	ON	Enables jumbo frame function
	OFF	Disables jumbo frame function
802.3az	ON	Enables the energy-efficient Ethernet function

	OFF	Disables the energy-efficient Ethernet function
100/1000BaseSFP	ON	Supports 100M SFP module
	OFF	Supports 1000M SFP module
Port Alarm	ON	Enables the corresponding PORT Alarm. If the port's link fails, the relay will form an open circuit and the fault LED will light up
	OFF	Disables the corresponding PORT Alarm. If the port's link fails, the relay will form a closed circuit and the fault LED will never light up



## ATTENTION

To actively update DIP switch settings, power off and then power on the switch.

## LED Indicators

The front panel of the EDS-G205-1GTXSFP switch contains several LED indicators. The function of each LED is described in the table below.

LED	Color	State	Description
PWR1	AMBER	On	Power is being supplied to power input PWR1
		Off	Power is not being supplied to power input PWR1
PWR2	AMBER	On	Power is being supplied to power input PWR2
		Off	Power is not being supplied to power input PWR2
FAULT	RED	On	When the corresponding PORT alarm is enabled, and the port's link is inactive.
		Off	When the corresponding PORT alarm is enabled and the port's link is active, or when the corresponding PORT alarm is disabled.
10/100/1000M	AMBER	On	TP port's 10/100 Mbps or SFP port's 100 Mbps link is active.
		Blinking	Data is being transmitted at 10/100 Mbps
		Off	TP port's 10/100 Mbps or SFP port 100 Mbps link is inactive.
	GREEN	On	TP/SFP port's 1000 Mbps link is active.
		Blinking	Data is being transmitted at 1000 Mbps
		Off	TP/SFP port's 1000 Mbps link is inactive

## Auto MDI/MDI-X Connection

The Auto MDI/MDI-X function allows users to connect the switch's 10/100/1000BaseT(X) ports to any kind of Ethernet device, without paying attention to the type of Ethernet cable being used for the connection. This means that you can use either a straight-through cable or cross-over cable to connect the switch to Ethernet devices.

## Three Speed Functionality and Switching

The switch's 10/100/1000 Mbps RJ45 switched port auto negotiates with the connected device for the fastest data transmission rate supported by both devices. The switch is a plug-and-play device, so software configuration is not required at installation or during maintenance.

The half/full duplex mode for the RJ45 switched ports is user dependent and changes (by auto-negotiation) to full or half duplex, depending on which transmission speed is supported by the attached device.

## Auto-Negotiation and Speed Sensing

The switch's RJ45 Ethernet ports independently support auto-negotiation for transmission speeds of 10 Mbps, 100 Mbps, and 1000 Mbps, with operation according to the IEEE 802.3 standard.

This means that some nodes could be operating at 10 Mbps, while at the same time, other nodes are operating at 100 Mbps or 1000 Mbps.

Auto-negotiation takes place when an RJ45 cable connection is made, and then each time a LINK is enabled. The switch advertises its capability for using 10 Mbps, 100 Mbps, or 1000 Mbps transmission speeds, with the device at the other end of the cable expected to advertise similarly. Depending on what type of device is connected, this will result in agreement to operate at a speed of 10 Mbps, 100 Mbps, or 1000 Mbps.

If the switch's RJ45 Ethernet port is connected to a non-negotiating device, it will default to 10 Mbps speed and half-duplex mode, as required by the IEEE 802.3 standard.

## ATEX Information

1. Certificate number:  
ATEX:DEMKO 14 ATEX 1443X
2. Ambient range:  
 $-40^{\circ}\text{C} \leq T_{\text{amb}} \leq +75^{\circ}\text{C}$  for Models with suffix of "-T";  
 $-10^{\circ}\text{C} \leq T_{\text{amb}} \leq +60^{\circ}\text{C}$  for Models without suffix of "-T".
3. Certification string:  
ATEX: Ex ec nC IIC T4 Gc
4. Standards covered:  
EN IEC 60079-0:2018  
EN IEC 60079-7:2015 + A1:2018  
EN IEC 60079-15:2019
5. Conditions of safe usage:
  - a. The equipment shall only be used in an area of at least pollution degree 2, as defined in EN 60664-1.
  - b. The equipment shall be installed in an enclosure that provides a minimum ingress protection of IP54 in accordance with EN IEC 60079-0 and accessible only by the use of a tool.



II 3G



## Specifications

Technology	
Standards	IEEE 802.3 for 10BaseT IEEE 802.3u for 100BaseT(X) and 100BaseFX IEEE 802.3ab for 1000BaseT(X)

	IEEE 802.3z for 1000BaseX IEEE 802.3x for Flow Control IEEE 802.3az for Energy-Efficient Ethernet
<b>Interface</b>	
RJ45 Ports	10/100/1000BaseT(X) auto negotiation speed, half/full duplex mode, and auto MDI/MDI-X connection
Fiber Ports	Optional 1000BaseSX/LX/LHX/ZX (LC connector) or 100BaseSFP
LED Indicators	PWR1, PWR2, FAULT, 10/100M/1000M
DIP Switch	Port break alarm, broadcast storm protection, jumbo frame, IEEE 802.3az, 100/1000BaseSFP
Alarm Contact	One relay output with current carrying capacity of 1A @ 24 VDC; resistance Class 2.

### Power Requirements

Input Voltage	12/24/48 VDC, redundant inputs, Class 2
Input Current	380 mA
Connection	One removable 6-pin terminal block
Overload Current Protection	Present
Reverse Polarity Protection	Present

### Physical Characteristics

Housing	IP30 protection, metal case
Dimensions	29 x 135 x 105 mm (1.14 x 5.31 x 4.13 in)
Weight	290 g
Installation	DIN rail, wall mounting (optional kit)

### Environmental Limits

Operating Temperature	-10 to 60°C (14 to 140°F) -40 to 75°C (-40 to 167°F) for -T models
Storage Temperature	-40 to 85°C (-40 to 185°F)
Ambient Relative Humidity	5 to 95% (non-condensing)

### Regulatory Approvals

Safety	UL 508
Hazardous Location	UL/cUL Class I, Division 2, Groups A, B, C, and D; ATEX Zone 2
EMI	FCC Part 15, CISPR (EN 55032) Class A
EMS	EN 61000-4-2 (ESD), Level 3 EN 61000-4-3 (RS), Level 3 EN 61000-4-4 (EFT), Level 3 EN 61000-4-5 (Surge), Level 3 EN 61000-4-6 (CS), Level 3 EN 61000-4-8
Marine	ABS, DNV, LR, NK
Rail Traffic	EN 50121-4
Shock	IEC 60068-2-27
Freefall	IEC 60068-2-32
Vibration	IEC 60068-2-6

### Warranty

Warranty Period	5 years
Details	See <a href="http://www.moxa.com/warranty">www.moxa.com/warranty</a>

## Supported SFP Modules

Model	Description
SFP-1FELLC-T	SFP module with 1 100Base single-mode with LC connector for 80 km transmission, -40 to 85°C operating temperature
SFP-1FEMLC-T	SFP module with 1 100Base multi-mode, LC connector for 2/4 km transmission, -40 to 85°C operating temperature
SFP-1FESLC-T	SFP module with 1 100Base single-mode with LC connector for 40 km transmission, -40 to 85°C operating temperature
SFP-1G10ALC	WDM-type (BiDi) SFP module with 1 1000BaseSFP port with LC connector for 10 km transmission; TX 1310 nm, RX 1550 nm, 0 to 60°C operating temperature
SFP-1G10ALC-T	WDM-type (BiDi) SFP module with 1 1000BaseSFP port with LC connector for 10 km transmission; TX 1310 nm, RX 1550 nm, -40 to 85°C operating temperature
SFP-1G10BLC	WDM-type (BiDi) SFP module with 1 1000BaseSFP port with LC connector for 10 km transmission; TX 1550 nm, RX 1310 nm, 0 to 60°C operating temperature
SFP-1G10BLC-T	WDM-type (BiDi) SFP module with 1 1000BaseSFP port with LC connector for 10 km transmission; TX 1550 nm, RX 1310 nm, -40 to 85°C operating temperature
SFP-1G20ALC	WDM-type (BiDi) SFP module with 1 1000BaseSFP port with LC connector for 20 km transmission; TX 1310 nm, RX 1550 nm, 0 to 60°C operating temperature
SFP-1G20ALC-T	WDM-type (BiDi) SFP module with 1 1000BaseSFP port with LC connector for 20 km transmission; TX 1310 nm, RX 1550 nm, -40 to 85°C operating temperature
SFP-1G20BLC	WDM-type (BiDi) SFP module with 1 1000BaseSFP port with LC connector for 20 km transmission; TX 1550 nm, RX 1310 nm, 0 to 60°C operating temperature
SFP-1G20BLC-T	WDM-type (BiDi) SFP module with 1 1000BaseSFP port with LC connector for 20 km transmission; TX 1550 nm, RX 1310 nm, -40 to 85°C operating temperature
SFP-1G40ALC	WDM-type (BiDi) SFP module with 1 1000BaseSFP port with LC connector for 40 km transmission; TX 1310 nm, RX 1550 nm, 0 to 60°C operating temperature
SFP-1G40ALC-T	WDM-type (BiDi) SFP module with 1 1000BaseSFP port with LC connector for 40 km transmission; TX 1310 nm, RX 1550 nm, -40 to 85°C operating temperature
SFP-1G40BLC	WDM-type (BiDi) SFP module with 1 1000BaseSFP port with LC connector for 40 km transmission; TX

	1550 nm, RX 1310 nm, 0 to 60°C operating temperature
SFP-1G40BLC-T	WDM-type (BiDi) SFP module with 1 1000BaseSFP port with LC connector for 40 km transmission; TX 1550 nm, RX 1310 nm, -40 to 85°C operating temperature
SFP-1GEZXLC	SFP module with 1 1000BaseEZXC port with LC connector for 110 km transmission, 0 to 60°C operating temperature
SFP-1GEZXLC-120	SFP module with 1 1000BaseEZXC port with LC connector for 120 km transmission, 0 to 60°C operating temperature
SFP-1GLHLC	SFP module with 1 1000BaseLH port with LC connector for 30 km transmission, 0 to 60°C operating temperature
SFP-1GLHLC-T	SFP module with 1 1000BaseLH port with LC connector for 30 km transmission, -40 to 85°C operating temperature
SFP-1GLHXLC	SFP module with 1 1000BaseLHX port with LC connector for 40 km transmission, 0 to 60°C operating temperature
SFP-1GLHXLC-T	SFP module with 1 1000BaseLHX port with LC connector for 40 km transmission, -40 to 85°C operating temperature
SFP-1GLSXLC	SFP module with 1 1000BaseLSX port with LC connector for 1km/2km transmission, 0 to 60°C operating temperature
SFP-1GLSXLC-T	SFP module with 1 1000BaseLSX port with LC connector for 1km/2km transmission, -40 to 85°C operating temperature
SFP-1GLXLC	SFP module with 1 1000BaseLX port with LC connector for 10 km transmission, 0 to 60°C operating temperature
SFP-1GLXLC-T	SFP module with 1 1000BaseLX port with LC connector for 10 km transmission, -40 to 85°C operating temperature
SFP-1GSXLC	SFP module with 1 1000BaseSX port with LC connector for 300m/550m transmission, 0 to 60°C operating temperature
SFP-1GSXLC-T	SFP module with 1 1000BaseSX port with LC connector for 300m/550m transmission, -40 to 85°C operating temperature
SFP-1GZXLC	SFP module with 1 1000BaseZX port with LC connector for 80 km transmission, 0 to 60°C operating temperature
SFP-1GZXLC-T	SFP module with 1 1000BaseZX port with LC connector for 80 km transmission, -40 to 85°C operating temperature