

DA-820 Series Quick Installation Guide

x86 Rackmount Embedded Computers

Edition 2.0, January 2018

Technical Support Contact Information **www.moxa.com/support**

Moxa Americas:

Toll-free: 1-888-669-2872

Tel: 1-714-528-6777

Fax: 1-714-528-6778

Moxa China (Shanghai office):

Toll-free: 800-820-5036

Tel: +86-21-5258-9955

Fax: +86-21-5258-5505

Moxa Europe:

Tel: +49-89-3 70 03 99-0

Fax: +49-89-3 70 03 99-99

Moxa Asia-Pacific:

Tel: +886-2-8919-1230

Fax: +886-2-8919-1231

Moxa India:

Tel: +91-80-4172-9088

Fax: +91-80-4132-1045

MOXA®

© 2018 Moxa Inc. All rights reserved.

P/N: 1802008200011



Overview

The DA-820's main operating system is based on the Intel® Core™ i3/i7/Celeron CPU and QM77 chipset, and supports x86 platforms. The DA-820 has 2 VGA connections, 6 USB ports, 4 Gigabit LAN ports, and 2 RS/232/422/485 3-in-1 serial ports, and is equipped with a 4 SATA disk interface and default support for RAID 0/1/5/10. In addition, the DA-820 is specifically designed for substation applications that require precise time synchronization and products meeting the IEC 61850-3 standard. The flexible design makes the DA-820 suitable for local SCADA, environmental monitoring, video surveillance, protocol conversion, and PRP/HSR redundancy applications, and the cybersecurity functionality allows you to maintain secure network communications.

Package Checklist

Each basic system model is shipped with following standard items:

- DA-820 rackmount computer
- Rackmount kit
- Quick Installation Guide
- Documentation and software CD
- Warranty card

Hardware Installation

Front View

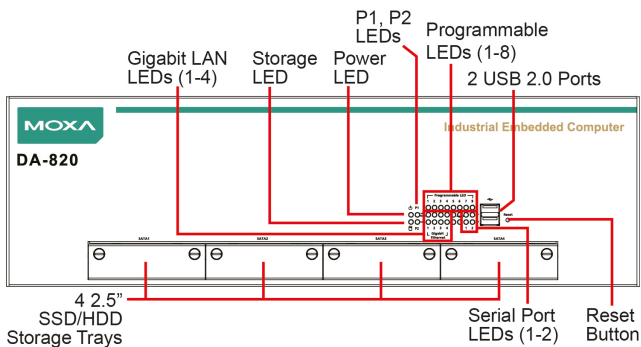



NOTE The power input supports two types of power supply:
HV: 100 to 240 VAC/VDC
LV: 24 to 110 VDC.





Connecting the Power

Use a screwdriver to loosen the terminal connector's clamp screws. Connect the power cord wires to the screws, and then retighten the screws. The **Power** LED will light up to indicate that power is being supplied to the DA-820, after which the BIOS will initialize the flash disk module, causing the **Storage** LED to blink. It should take about 30 to 60 seconds for the operating system to complete the boot process.



Alternating Current (AC),
Single Power

INPUT 100-240VAC/VDC PWR 1				
+ / L 1	 3	COM 5	7	9
- / N 2	 4	NO 6	8	10





Alternating Current (AC),
Dual Power

INPUT 100-240VAC/VDC PWR 1			INPUT 100-240VAC/VDC PWR 2		
+ / L 1	 3	COM 5	 7	+ / L 9	
- / N 2	 4	NO 6	 8	- / N 10	

Direct Current (DC),
Single Power

INPUT 24-110 VDC PWR 1				
+ 1	 3	COM 5	7	9
- 2	 4	NO 6	8	10

Direct Current (DC),
Dual Power

INPUT 24-110 VDC PWR 1			INPUT 24-110 VDC PWR 2		
+ 1	 3	COM 5	 7	+ 9	
- 2	 4	NO 6	 8	- 10	

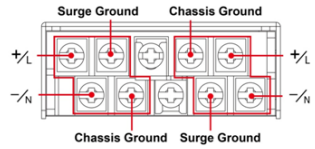
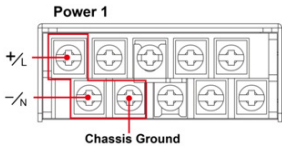

Rear View

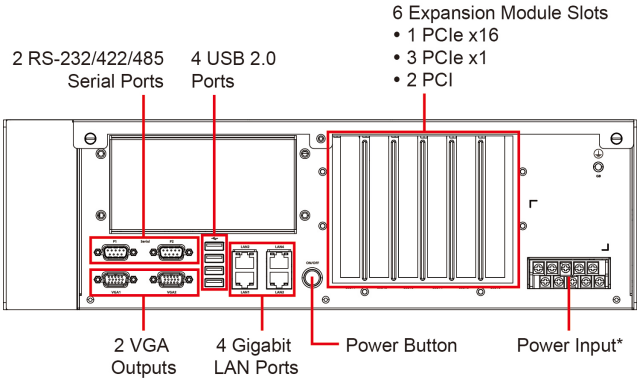

For detailed power connection and surge protection information, refer to the *DA-820 Hardware User's Manual*.

Front Panel LEDs

There are 28 LED indicators on the front panel. The LEDs are described in the following table:

LED	Color	Description
Power	Green	Power is on
	Off	No power input
Storage	Yellow/ Blinking	Data is being written to or read from the storage unit
	Off	Storage unit is idle
P1 (Non-functional for single power supply)	Off	The 1st power supply is on
	Red	Error in the 2nd power supply
P2 (Non-functional for single power supply)	Off	The 2nd power supply is on
	Red	Error in the 1st power supply
Gigabit LAN LEDs 1-4	Green	100 Mbps Ethernet mode
	Orange	1000 Mbps (Gigabit) Ethernet mode
Serial Port 1/2	Green	Tx
	Yellow	Rx
Programmable 1-8	Green/ Blinking	The programs 1-8 that are in process

Connecting to a Display

The DA-820 comes with 2 VGA interfaces that use D-Sub 15-pin female connectors.

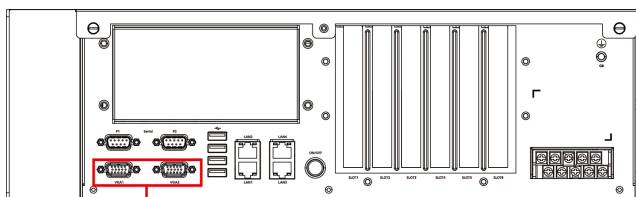

2 VGA Outputs

USB Ports

The DA-820 comes with 6 USB 2.0 ports, with 4 on the rear panel and 2 on the front panel. The USB ports can be used to connect a keyboard, mouse, or other peripherals, such as flash drives for expanding the system's storage capacity.

Serial Ports

The DA-820 comes with 2 software-selectable RS-232/422/485 serial ports on the rear panel. The ports use DB9 male connectors. Refer to the following table for pin assignments:

Pin	RS-232	RS-422	RS-485 (4-wire)	RS-485 (2-wire)
1	DCD	TxDA(-)	TxDA(-)	-
2	RxD	TxDB(+)	TxDB(+)	-
3	TxD	RxDB(+)	RxDB(+)	DataB(+)
4	DTR	RxDA(-)	RxDA(-)	DataA(-)
5	GND	GND	GND	GND
6	DSR	-	-	-
7	RTS	-	-	-
8	CTS	-	-	-

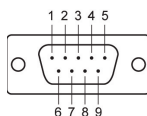

Ethernet Ports

The DA-820 has 4 100/1000 Mbps RJ45 Ethernet ports. Refer to the following table for pin assignments:

Pin	100 Mbps	1000 Mbps
1	Tx+	TRD(0)+
2	Tx-	TRD(0)-
3	Rx+	TRD(1)+
4	-	TRD(2)+
5	-	TRD(2)-
6	Rx-	TRD(1)-
7	-	TRD(3)+
8	-	TRD(3)-

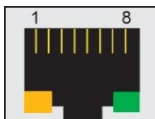

The default IP addresses and netmasks of the Ethernet ports are shown below. Note that the W7E models default to DHCP.

	Default IP Address	Netmask
LAN 1	192.168.3.127	255.255.255.0
LAN 2	192.168.4.127	255.255.255.0
LAN 3	192.168.5.127	255.255.255.0
LAN 4	192.168.6.127	255.255.255.0

Installing Removable Storage

The DA-820 has 4 hot-swappable 2.5" SSD/HDD storage trays located on the front panel for installing additional storage drives. Remove the screws on the trays to install the SSD/HDD storage drives. RAID 0, 1, 5, and 10 are supported.

Configuring the Ethernet Interface

Linux Users:

To configure the network settings on your DA-820 for the first time, use the following commands to edit the interfaces file. First, make sure all network interfaces are offline before you reconfigure the LAN settings.

```
MOXA:~# ifdown -a
```

Next, edit the network interfaces file. The default editor on the DA-820 is vi; however, you may use a text editor of your choice.

```
MOXA:~#vi /etc/network/interfaces
```

You may set the DA-820 for either dynamic IP addressing or static IP addressing. For dynamic IP addressing, enter the following lines into the network interfaces file:

```
# The primary network interface
auto eth0
iface eth0 inet dhcp
```

To configure an interface for static IP addressing, use the following configuration. Each interface must be configured with separate entries in the network/interfaces file; LAN1 corresponds to eth0, LAN 2 corresponds to eth1, and so on for the remaining interfaces.

```

# The loopback network interface
auto lo
iface lo inet loopback

# The first LAN interface, LAN 1
auto eth0
iface eth0 inet static
    address 192.168.3.127
    netmask 255.255.255.0
    broadcast 192.168.3.255

# The second LAN interface, LAN 2
auto eth1
iface eth1 inet static
    address 192.168.4.127
    netmask 255.255.255.0
    broadcast 192.168.4.255

```

Exit the vi editor by typing:

```
:wq
```

After the interfaces file has been configured, use the following commands to reinitialize the network interfaces and activate the new settings immediately:

```
Moxa:~#sync; ifup -a
```

Windows 7 Users

Step 1: Go to **Start** → **Control Panel** → **Network and Internet** → **Network Connections**.

Step 2: On the **Local Area Connection Properties** screen, click **Internet Protocol (TCP/IP)** and select **Properties**.

Step 3: Click **OK** after inputting the preferred IP address and netmask.

