

AIG-301-T-CN-AZU-LX and AIG-301-CN-AZU-LX Quick Installation Guide

Advanced IIoT gateway with Arm® Cortex™-A7 dual-core 1 GHz processor, 1 CAN port, 4 DIs, 4 DOs, ThingsPro Edge and Azure IoT Edge software, -20 to 70°C and -40 to 70°C operating temperature ranges

Version 1.0, December 2021

Technical Support Contact Information
www.moxa.com/support

MOXA®

© 2021 Moxa Inc. All rights reserved.

P/N: 1802003015020



Package Checklist

Before installing the device, verify that the package contains the following items:

- AIG-300 Series CN model advanced IIoT gateway
- Power jack
- DIN-rail mounting kit
- Quick installation guide (printed)
- Warranty card



IMPORTANT!

The console cable is not included in the package; you need to purchase it separately. Notify your sales representative if any of the above items are missing or damaged.

Panel Views

The following figures show the panel layouts of the device.

NOTE The CN models do not come preinstalled with the LTE module. Contact Moxa's distributor in China for more information.

Top Panel

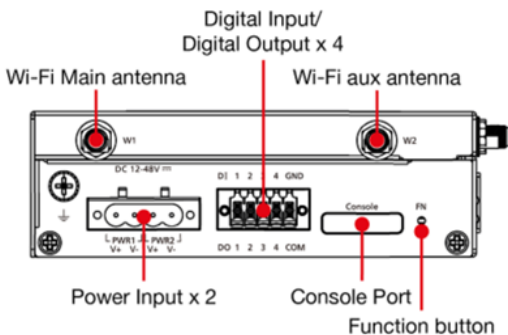

Front Panel

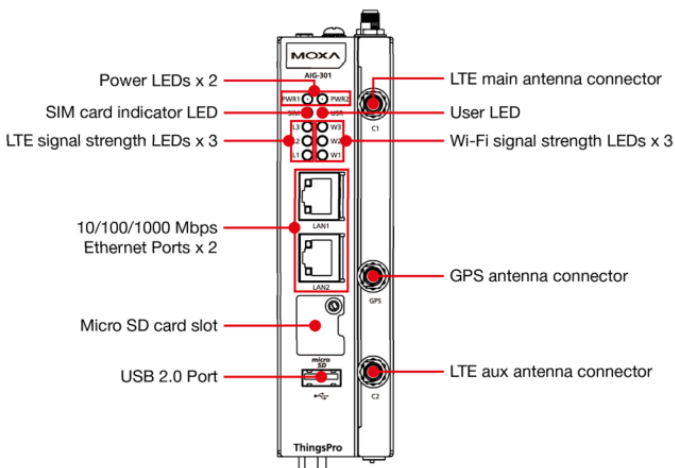

Bottom Panel View

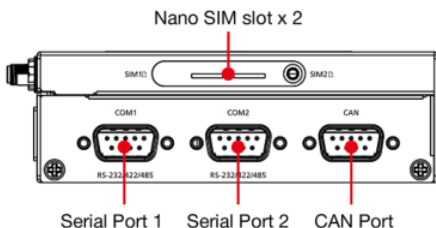

LED Indicators

LED Name	Status	Function	
PWR1/PWR2	Green	Power is on	
	Off	No power is supplied	
SIM	Green	SIM2 in use	
	Yellow	SIM1 in use	
USR	Green/Yellow	Green: System is operating normally Yellow: System is initializing and running the initial boot-up process	
L1/L2/L3	Yellow	Cellular signal strength	
		L1+L2+L3: Strong	
		L2+L3: Normal L3: Weak	
W1/W2/W3	Yellow	WLAN signal strength	
		W1+W2+W3: Strong	
		W2+W3: Normal W3: Weak	
LAN1/LAN2 (RJ45 connector)	Green	Steady on	1000 Mbps Ethernet link
		Blinking	Data is being transmitted
	Yellow	Steady on	100 Mbps Ethernet link
		Blinking	Data is being transmitted
Off	No Ethernet connection or 10 Mbps Ethernet link		

Mounting Instructions

DIN-rail Mounting

The aluminum DIN-rail attachment plate is already attached to the product's casing. To mount the device on to a DIN rail, make sure that the stiff metal spring is facing upwards and follow these steps.

1. Pull down the bottom slider of the DIN-rail bracket located at the back of the unit
2. Insert the top of the DIN rail into the slot just below the upper hook of the DIN-rail bracket.
3. Latch the unit firmly on to the DIN rail as shown in the illustrations below.
4. Push the slider back into place.

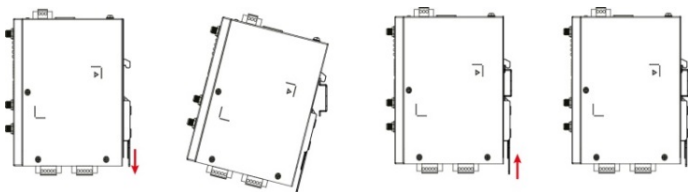
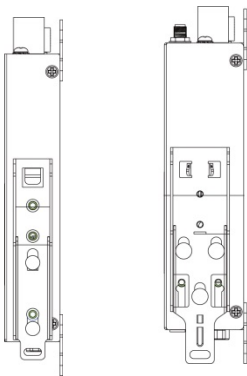

Wall Mounting (optional)

The device can be mounted on to a wall using a wall-mounting kit. The optional wall-mounting kit should be purchased separately.

Follow these steps to mount the device on to a wall:

Step 1

Use four screws to fasten the wall-mounting brackets on the left panel of the device.

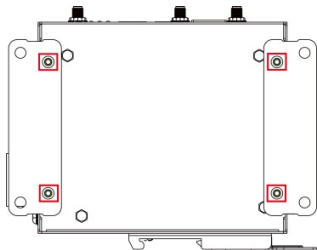

Step 2

Use another four screws to mount the device on to a wall or in a cabinet.

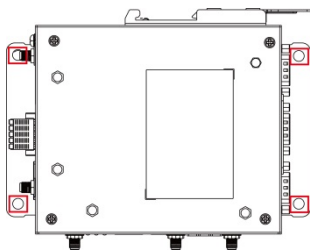



IMPORTANT!

The diameter of the screw heads should be greater than 7 mm and less than 14 mm; the diameter of the shafts should be less than 3 mm. The length of the screws should be greater than 6 mm.

- NOTE**
- Test the screw head and shank size by inserting the screws into one of the keyhole shaped apertures of the wall-mounting plates before attaching the plate to the wall.
 - Do not drive the screws in all the way—leave a space of about 2 mm to allow room for sliding the wall mount panel between the wall and the screws.

Wiring Requirements

- Use separate paths to route wiring for power and devices. If power wiring and device wiring paths must cross, make sure the wires are perpendicular at the intersection point.
- You can use the type of signal transmitted through a wire to determine which wires should be kept separate. The rule of thumb is that wiring that shares similar electrical characteristics can be bundled together.
- Keep input wiring and output wiring separate.
- When necessary, it is strongly advised that you label wiring to all devices in the system.

- NOTE** Do not run signal or communication wiring and power wiring in the same wire conduit. To avoid interference, wires with different signal characteristics should be routed separately.

Grounding Requirements

There is a grounding connector located on the top panel of the device. Connect it to an appropriate grounded metal surface. Grounding and wire routing help limit the effects of noise due to electromagnetic interference (EMI).

Connecting the Power Supply

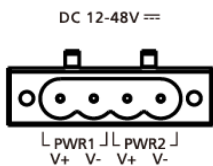

Connect the power jack (in the package) to the DC terminal block (located on the top panel), and then connect the power adapter. It takes about 3 minutes for the system to boot up. Once the system is ready, the Power LED will light up. Both models support dual power inputs for redundancy.

Use wires with 12 to 26 AWG wire size to connect to V+, V-, and GND.

The wire size of the power input and the earthing conductor should be the same. Remove 8 to 9 mm of the DC wires' protective cover and use a torque of 4.5lb-in/0.51Nm to connect the wire. The max. wire temperature should not exceed 100°C. The terminal blocks do not accommodate more than one conductor wire per clamping point.



WARNING

- This product is intended to be supplied by a UL Listed power adapter or DC power source whose output meets SELV/LPS. The power source must be rated 12 to 48 VDC, minimum 1 A, and minimum TMA = 85°C.
- The power adapter should be connected to a socket outlet with an earthing connection.

If you need further information or assistance, contact a Moxa representative.

Wiring the I/Os

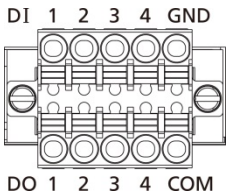

There are four digital inputs and four digital outputs on the top panel. Refer to the figure on the left for detailed pin definitions.

Use wires with 16 to 28 AWG wire size to connect to DI, DO, and GND.

The exposed conductor wire length should be 7-8 mm and the max. wire temperature should not exceed 100°C. The terminal blocks do not accommodate more than one conductor wire per clamping point.

DI Dry Contact

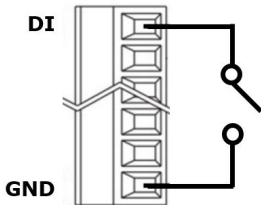

DO Channel (Sink Type)

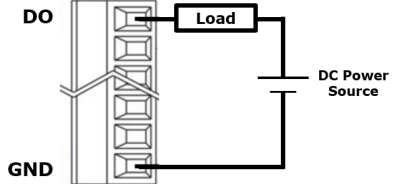

Communication Connections

Connecting to the Network

The two 10/100/1000 Mbps Ethernet ports (LAN 1 and LAN 2) use RJ45 connectors. The pin assignments are shown in the following table:

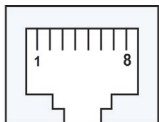

Pin	10/100 Mbps	1000 Mbps
1	Tx+	TRD(0)+
2	Tx-	TRD(0)-
3	Rx+	TRD(1)+
4	-	TRD(2)+
5	-	TRD(2)-
6	Rx-	TRD(1)-
7	-	TRD(3)+
8	-	TRD(3)-

Connecting to Serial Ports

The two serial ports (P1 and P2) use DB9 interface. Each port can be configured by software for RS-232, RS-422, or RS-485. The pin assignments for the ports are shown in the following table:

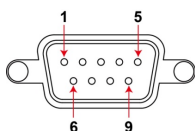

Pin	RS-232	RS-422/ RS-485 4w	RS-485 2w
1	-	TxD-(A)	-
2	RxD	TxD+(B)	-
3	TxD	RxD+(B)	Data+(B)
4	DTR	RxD-(A)	Data-(A)
5	GND	GND	GND
6	DSR	-	-
7	RTS	-	-
8	CTS	-	-

Inserting the microSD Card

The device comes with a micro-SD slot for storage expansion. The microSD slot is located at the lower part of the front panel. To install the card, remove the screw and the protection cover to access the slot and insert the microSD card into the slot.

You will hear a click when the card is in place. To remove the card, push the card in before releasing it.



Connecting to the Console Port

The console port is an RS-232 port located on the top panel, and can be connected to a 4-pin pin header cable. You can use this port for debugging or firmware upgrade.



Pin	Signal
1	TxD
2	RxD
3	NC
4	GND

Connecting a USB Device

The device comes with a USB port located on the lower part of the front panel, allowing users to connect to a device with an USB interface. The USB port uses a type-A connector.

Connecting a CAN Device

A CAN port with a DB9 interface is located on the bottom panel. Refer to the figure below for detailed pin definitions.

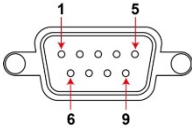

Pin	Definition
1	-
2	CAN_L
3	CAN_GND
4	-
5	(CAN_SHLD)
6	(GND)
7	CAN_H
8	-
9	(CAN_V+)

Inserting a SIM Card

The device comes with two SIM card slots to install up to two SIM cards for cellular communication.

Step 1

Remove the screw on the SIM card holder located on the bottom panel of the device.

Step 2

Insert the SIM card into the socket. Make sure you insert it in the right direction. To remove the SIM card, press the SIM card in to release and then pull out the SIM card.



Connecting the Antennas



There are two cellular antenna connectors (C1 and C2) on the front panel of the device. In addition, a GPS connector is provided for the GPS module. All three are SMA type connectors. Connect the antennas to these connectors as indicated.



The device also comes with two Wi-Fi antenna connectors (W1 and W2) on the top panel of the device. Connect the antennas on the connectors as shown below. Both W1 and W2 connectors are of RP-SMA type.

NOTE The optional Wi-Fi wireless module is not included in the product package and must be purchased separately. Refer to the "AIG-300 Series hardware manual", which can be downloaded from <https://www.moxa.com>, to install the Wi-Fi module for the device.

Connecting the Device to a PC

You can use a PC to access the AIG-300 Series by one of the following methods:

- A. Access the web console of ThingsPro Edge via LAN 2 by <https://192.168.4.127:8443/>.

Default Username : **admin**

Password: **admin@123**.

- B. Using SSH over the network.

Refer to the following IP addresses and login information:

	Default IP Address	Netmask
LAN 1	DHCP	
LAN 2	192.168.4.127	255.255.255.0

Login: moxa

Password: moxa

NOTE For security reasons the SSH port is disabled by default. You can enable it via the ThingsPro Edge web console.

Troubleshooting

Reboot

To reboot the device, press the **Function (FN)** button for 1 second.

Reset to Default

Press and hold the **Function (FN)** button between 7 to 9 seconds to reset the device to the factory default settings. When the reset button is held down, the **USR** LED will blink once every second and become steady after 7 to 9 seconds. Release the button within this period to load the factory default settings.

Real-time Clock

The real-time clock is powered by a lithium battery. We strongly recommend that you do not replace the lithium battery without the help of a Moxa support engineer. If you need to change the battery, contact the Moxa RMA service team.



ATTENTION

There is a risk of explosion if the battery is replaced with an incorrect type of battery.

Product Specifications

Input Current	0.5 A @ 12 VDC
Input Voltage	12 to 48 VDC
Power Consumption	6.0 W
Operating Temperature	AIG-301-CN-AZU-LX: -20 to 70°C (-4 to 158°F) AIG-301-T-CN-AZU-LX: -40 to 70°C (-40 to 158°F)
Storage Temperature (package included)	-40 to 85°C (-40 to 185°F)

The latest specifications for Moxa's products can be found at <https://www.moxa.com>.